

Journal of Milk & Food Technology

C

2

4

7

4

1

JOURNAL OF

MILK
TECHNOLOGY



Volume 1

Number 6

SEPTEMBER, 1938

*Twenty-seventh Annual Meeting
Cleveland, Ohio, October 19-21, 1938
Headquarters, The Allerton*



Official Publication of
INTERNATIONAL ASSOCIATION OF
MILK SANITARIANS

(Association Organized 1911)

COMPLETELY PROTECT POURING LIPS? OF COURSE

The Standard Welded Wire Hood Seal
has been doing it for years on billions of milk bottles!

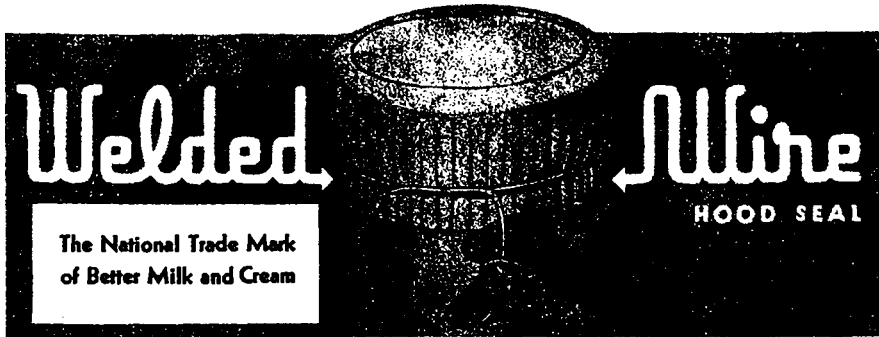

WHY HEALTH OFFICERS PREFER THE *Welded Wire* SEAL

1. The dairy-sterilized pouring lip is completely covered by the "long skirt" on the hood.
2. The hood completely covers the top of the milk bottle—keeps out germ-laden dust and dirt—completely protects the milk from the dairy to the kitchen.
3. It is strong and waterproof; heavy icing will not puncture or weaken it.
4. The Welded Wire Seal is tamper-proof. The hood is securely locked in place by the Welded Wire. It cannot be pulled off or joggled off in handling.
5. Because the Welded Wire Seal is tamper-proof, the customer is always the first to break the seal.
6. The Welded Wire Seal is easy to open. No tools or gadgets are necessary.

WHY DAIRY OWNERS CHOOSE THE *Welded Wire* SEAL

1. It's the **BEST** completely tamper-proof and sanitary closure they can buy.
2. The hood has ample printing surface for name, trade-mark and Health Board Requirements.
3. It is easily adapted to any standard bottle. No investment in special bottles.
4. Welded Wire Sealing machines are made in a variety of sizes to synchronize with any size bottle filler.
5. Welded Wire Sealers are quickly, easily installed by competent dairy engineers in any bottling room and are designed to provide economical plant operation.
6. It's the *best known* closure. Nationwide consumer advertising has made it the **NATIONAL TRADEMARK OF BETTER MILK AND CREAM.**

Milk sanitarians interested in hood-capping are invited to write for free leaflets.
Address: Standard Cap and Seal Corporation, 1200 Fullerton Ave., Chicago, Illinois.

When writing to advertisers, say you saw it in this Journal.

VITAMIN D MILK
BY VITEX PROCESS
400 USP UNITS PER QT.

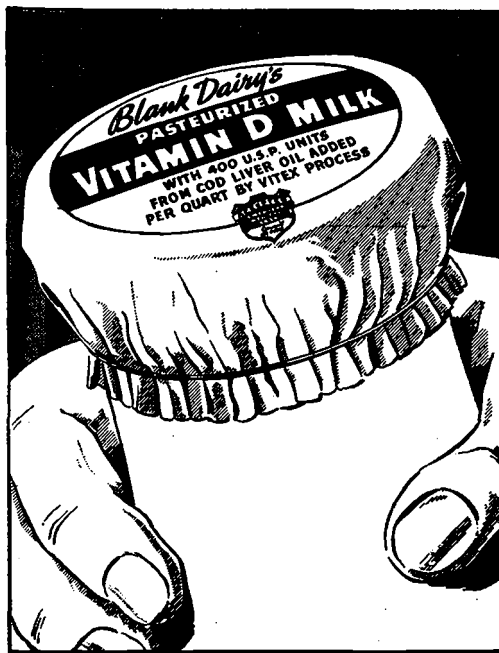

● Milk caps and labels for Vitex Vitamin D milks must be approved by state and city food control officials before the milk is distributed within their jurisdiction.

Biological assays in Laboratories acceptable to the particular food control officials help to maintain the vitamin D potency claimed on the milk cap—400 USP units of vitamin D per quart, extracted from cod liver oil by the Vitex Process.

VITEX LABORATORIES, INC.

A Nopco Subsidiary

HARRISON, NEW JERSEY

For over 81 years the name

Borden's

has stood for milk that can
be depended upon for un-
failing purity and richness.

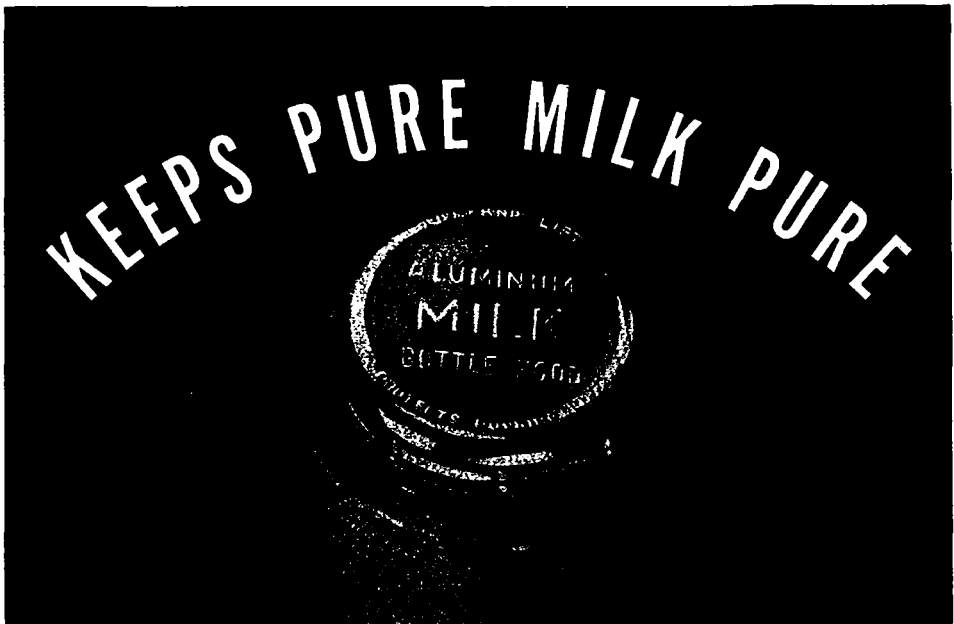

Unprotected pouring lips are on the way out. Sanitation demands covering this vital part of bottles with hoods such as the Alseco Aluminum Hood. Get further facts about it from ALUMINUM SEAL COMPANY, 1347 Third Ave., New Kensington, Pa.

T.M. Reg.  U. S. Pat. Off.
Alseco ALUMINUM
MILK BOTTLE HOODS

When writing to advertisers, say you saw it in this Journal.

FROM 16 To 60 QUARTS—

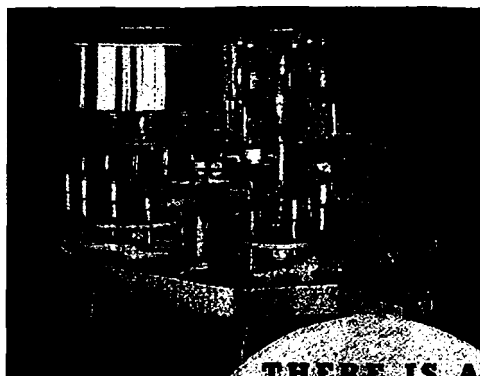

● At the left is the No. 5 which fills and caps 60 quarts and upward of cold milk per minute, every minute. It has the stamina, the ability to take punishment for which CP-built machines are noted. Sanitary—good looking. Stainless steel bowl. Variable speed drive which enables you to match your washer capacity exactly and other features you will want to know about before you select your next filler.

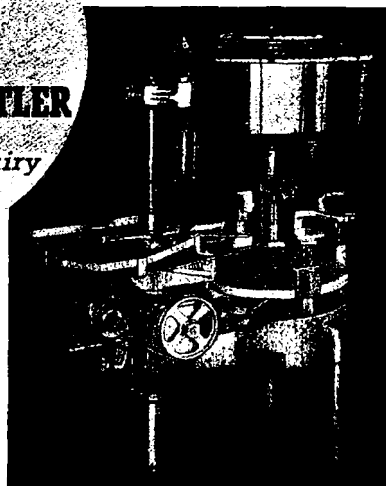

● At the other end of the capacity scale is the CP Roto-Matic No. 8. See illustration at the right. It is a real "rotary". Stainless steel bowl with 4 valves and one capper. Has a simple drive that cannot get out of time. Variable speed fills 12 to 24 bottles per minute. The ideal bottler for the large producer-dairy and for specials in the larger plants. The low cost will interest you.

In between, there are two other sizes. Put your bottling problems up to CP.

THE CREAMERY PACKAGE MFG. COMPANY

1243 WEST WASHINGTON BOULEVARD - - - - Chicago, Illinois

Branches: Atlanta - Boston - Buffalo - Chicago - Dallas - Denver - Kansas City - Los Angeles
 Minneapolis - New York - Omaha - Philadelphia - Portland, Oregon - Salt Lake City
 San Francisco - Seattle - Toledo - Waterloo, Iowa

CREAMERY PACKAGE MFG. CO. OF CANADA, LTD.
 267 King St. West, Toronto, Ont., Canada

THE CREAMERY PACKAGE MFG. COMPANY, LTD.
 Avery House, Clerkenwell Green, London E. C. 1, Eng.

When writing to advertisers, say you saw it in this Journal.

THE
New
 "6-16"

- COMPACT
- SIMPLE
- ECONOMICAL
- RUGGED
- EFFICIENT
- RUNNING IN OIL

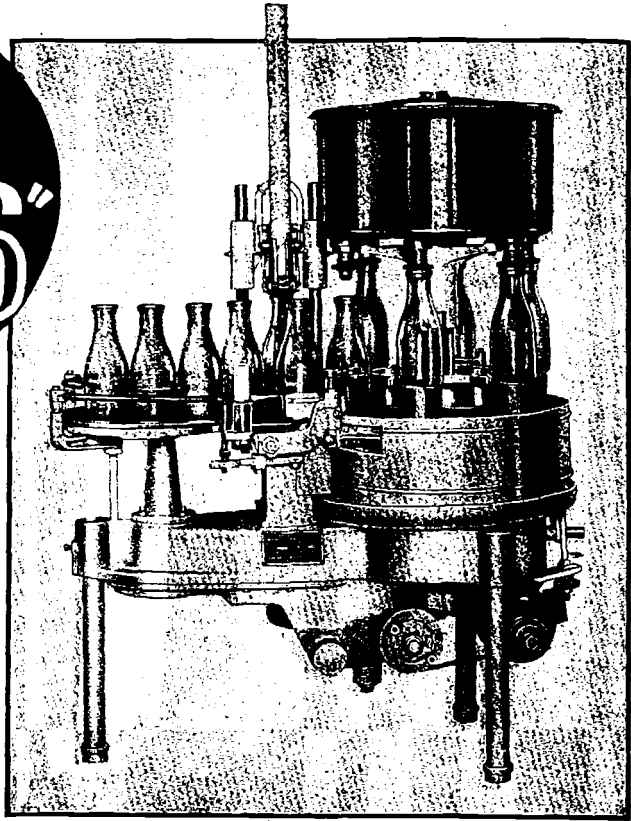

*Cherry-Burrell 6-16 Bottle Filler — capacity
 is 16 quarts per minute.*

CHERRY - BURRELL SALUTES THE SMALLER MILK PLANT OPERATORS with a NEW BOTTLE FILLER BUILT ESPECIALLY FOR THEIR NEEDS

THE new 6-16 BOTTLE FILLER AND CAPPER by CHERRY-BURRELL has most of the features of the larger fillers and cappers—yet is designed and priced for small milk plant owners having from 200 to 500-gallon capacities per day.

Whether hand fed or with Automatic Bottle Conveyor Infeed from a Baltimore Soaker Type Washer the "6-16" efficiently fills and caps all products in any size standard milk bottles at the rate of 16 full quarts to the minute.

Successful filling and capping of special products makes the "6-16" a most useful machine in large plants as well. Write us today for Bulletin No. G-319 which illustrates the 18 features of the new CHERRY-BURRELL 6-16 BOTTLE FILLER AND CAPPER or call your nearest CHERRY-BURRELL sales office.

CHERRY-BURRELL CORPORATION ~ 427 W. RANDOLPH ST., CHICAGO

JOURNAL OF MILK TECHNOLOGY

Official Publication of
The International Association of Milk Sanitarians
(Association Organized 1911)

Volume 1

September, 1938

Number 6

CONTENTS

	<i>Page No.</i>
Editorials	1
A Glass Milk Bottle with Narrow Pouring Lip and Minimum Drip— Lloyd Arnold	5
A Study of a Scarlet Fever Epidemic at Rockford, Illinois—C. W. Anderson and S. V. Layson	15
Problems Related to Homogenized Milk—F. J. Doan.....	20
Report of Committee on Communicable Diseases Affecting Man—I. A. Merchant, <i>Chairman</i>	26
Note on the Starch-Iodide Test for the Detection of Free Chlorine in Milk— T. H. Butterworth	36
A New Bacteriological Control Unit—Maurice H. Shorago.....	37
Report of Committee on Milk Plant Practice—A. R. Tolland, <i>Chairman</i>	38
The Quality Improvement of Creamery Butter—M. E. Parker, <i>Chairman</i>	44
Fiber from Casein	48
A Special Invitation to Milk Sanitarians to Attend the Dairy Industries Exposi- tion—Roberts Everett	49
Cleveland—Our Convention City—H. O. Way, <i>Chairman</i>	50
Tentative Program of the 1938 Convention	53
New Food Standards Committee	55
Information Concerning Journal of Milk Technology.....	56
Index to Advertisers	VIII

INTERNATIONAL ASSOCIATION OF MILK SANITARIANS

Secretary's Office: State Department of Health, State Office Building, Albany, N. Y.

OFFICERS 1937-1938

<i>President</i> , Alexander R. Tolland.....	Boston, Mass.
<i>First Vice-President</i> , Victor M. Ehlers.....	Austin, Texas
<i>Second Vice-President</i> , Paul B. Brooks, M. D.....	Albany, N. Y.
<i>Third Vice-President</i> , Leslie C. Frank.....	Washington, D. C.
<i>Auditors</i> : J. R. Jennings.....	Chicago, Ill.
F. D. Holford	New York City
<i>Secretary-Treasurer</i> , C. Sidney Leete.....	Albany, N. Y.

EXECUTIVE BOARD

The Executive Board consists of the Association President, the three Vice-Presidents, and the Secretary-Treasurer

COMMITTEES AND COMMITTEE CHAIRMEN

COMMUNICABLE DISEASES AFFECTING MAN—Their Relation to Public Milk Supplies	
I. A. Merchant, <i>Chairman</i>	Ames, Iowa
DAIRY AND MILK PLANT EQUIPMENT	
Walter D. Tiedeman, <i>Chairman</i>	Albany, N. Y.
SANITARY PROCEDURE	
Walter D. Tiedeman, <i>Chairman</i>	Albany, N. Y.
DAIRY FARMS METHODS	
F. D. Holford, <i>Chairman</i>	New York City
SANITARY CONTROL OF ICE CREAM	
F. W. Fabian, <i>Chairman</i>	East Lansing, Mich.
LABORATORY METHODS	
A. H. Robertson, <i>Chairman</i>	Albany, N. Y.
METHODS OF IMPROVING MILK SUPPLIES IN SMALL COMMUNITIES	
Leslie C. Frank, <i>Chairman</i>	Washington, D. C.
PUBLICITY AND PUBLIC RELATIONS	
H. A. Ocker, <i>Chairman</i>	Cleveland, Ohio
RESOLUTIONS	
Ernest Kelly, <i>Chairman</i>	Washington, D. C.
LOCAL COMMITTEE ON ARRANGEMENTS FOR THE 1938 MEETING	
H. O. Way, <i>Chairman</i>	Cleveland, Ohio

JOURNAL of MILK TECHNOLOGY

Volume 1

September, 1938

Number 6

Editorials

*The opinions and ideas expressed in papers and editorials are those of the respective authors.
The expressions of the Association are completely recorded in its transactions.*

Greetings to the Members of the International Association of Milk Sanitarians

We always have good conventions. The programs are practical and cover a wide range of subjects of interest to milk sanitarians in official, educational, research, and commercial fields. This year will be noteworthy for several reasons.

In the first place, we have a most cordial invitation from the management of the Dairy Industries Exposition to visit the great machinery and supplies exhibit. This will be larger than ever before. No milk sanitarian who wants to keep up on the latest developments can afford to miss it.

Moreover, our Association membership has increased greatly in numbers during the past year. We want to meet personally the new members. We anticipate the mutual profit and pleasure of exchanging ideas, and cementing professional ties with friendship.

This great increase in membership has brought wider knowledge, new blood, and additional funds into our organization. These will surely make their influence felt in a stronger program and a more attractive meeting.

Then again, we have our young and vigorous Journal of Milk Technology. It is one of our major assets. It has largely been responsible for our exceptional growth and strength. It is receiving wider and wider recognition here and abroad. We must support Bill Palmer and Doc Shrader in making it an increasingly potent factor in improving the quality of dairy products everywhere and rendering a real service to mankind.

Proposals of state associations to affiliate with our organization will necessitate our voting on several amendments. Come, and help us guide the future development of the International.

Is there an organization of milk sanitarians in your state? If not, why not? Come to Cleveland, and talk the matter over with others similarly interested. Have you a perplexing control problem? Tell us about it; maybe some one will have had the same one. Maybe you can help us in ours.

So come to Cleveland. Participate in the meetings of your Association; secure more of the newer knowledge of milk technology; renew your personal and professional friendships, and make new ones. The added inspiration will pay dividends throughout the year to you personally and to those you represent.

A. R. TOLLAND,
President International Association of Milk Sanitarians.

The Digestibility of Cheese

Cheese is one of the cheapest and most nutritious dairy products, but in the United States its per capita consumption lags far behind that of other dairy products. This rate is one-half that of Italy, Norway, Germany, France, and Sweden, one-third that of Denmark and Holland, and only about one-fourth that of Switzerland.

Deep-seated in the public consciousness, there is a belief that cheese is indigestible. An incident is recalled wherein the practice of eating cheese with pie was explained as due to the stimulation of the digestion of the pie by the more indigestible cheese—a doubtful compliment at best.

This persistent belief in the difficult digestibility of cheese tends to limit its consumption. People do not eat much of a product they think may cause digestive distress. Is cheese really so indigestible?

Experimental studies on the digestibility of cheese were made by Doane back in 1911. Sixty-five young men were supplied with cheese to furnish protein and fat to a basal ration. These investigations showed that old and new American Cheddar cheeses of different degrees of ripeness exhibited no important differences in their comparative digestibility. In no case were there physiological disturbances or constipation as a result of the cheese diet. Since that somewhat distant date, no researches on the digestibility of cheese seem to have been undertaken (or at least published), except that a study on two young women would "seem to indicate" that the calcium of American Cheddar cheese was as well utilized as that of pasteurized whole milk. In view of the great importance of cheese as a highly nutritious and palatable protein food, it does seem strange that this popular belief in its indigestibility has not been challenged by a wealth of experimental evidence. It is not enough to know that 27 years ago some experiments showed that cheese was as digestible as meat. That work was performed before the present technic of nutritional research had been developed. Studies should be undertaken with the improved methods of today, including all the controls which present knowledge of metabolism show are necessary. The studies should comprise nutritive value, digestive comfort, ease and completeness of digestibility, and general effect on physical well-being,—all actually determined and not largely inferred from the proximate analysis by analogy to milk.

The situation amounts to this: old experiments state that cheese is completely and comfortably digestible, but 27 years later the great bulk of the population are afraid of the physiological effects of eating cheese.

New experimental researches should be inaugurated to study this problem. If this work should confirm the earlier reports, the results should not be hid under a bushel (buried in bulletins which are not readily obtainable or out of print) but publicized far and wide. We note research activity on the digestibility and food values of milk, milk powder, and evaporated milk. Cheese needs such investigation more than any of these because it is the dairy product about which we are least informed.

J. H. S.

Frontiers of Promising Milk Research

Milk will be one of the several farm commodities to be studied in the new research program authorized by the Agricultural Adjustment Act of 1938. By Section 202 of the Act, the Secretary of Agriculture is instructed to establish four regional laboratories in which research will center on developing new uses and market outlets for agricultural products. An appropriation of four million dollars must be divided equally among them. Four research areas have been designated by Secretary Wallace, and milk is one of the products assigned to the laboratory of the Eastern area, although the results are intended for use throughout the country. It is planned to consult with research institutions and representatives of producers and of industries as to the work on the commodities named.

As a development of farm chemistry, the component constituents of milk, individually or combined, must compete in industry with chemicals of controlled specification, dependable constancy, and known purity. Unless the milk industry knows as much about its products as the competing food and chemical industries know about their products, the marketability of milk or any of its constituents for industrial purposes is at a disadvantage.

Although more fundamental research is needed to acquaint us with the composition and properties of milk, it is probable that the proposed research program will be directed to the more immediate objective of finding profitable uses in new markets. The plan to place the research laboratories in the actual producing areas is well conceived. Academic and other aspects of fundamental research thrive when isolated from the distractions of commerce, but successful industrial research must be catalyzed by intimate contact with industry itself.

What are the possibilities for profitable milk research? First, what is the present situation? Nutritionally, milk is recognized as a preeminent food. Its effect on growth, bone structure, and general health have been fully demonstrated. But in none of these qualities is it different from substitute products—and we see soybean milk looming. The nutritional value of milk has been determined almost exclusively by these physical measurements. Has milk any uniqueness that is not equalled by any practically available substitute? Apparently, yes. Its lactose is partly composed of the carbohydrate galactose which is a necessary constituent of nerve and brain tissue. What is the nutritional effect of milk on the nervous system, on brain power, on intelligence of action? We do not know. This neglected field is as important as that of skeletal structure.

Casein is used in large amounts for paper sizing, adhesives, and to a less extent for plastics. Its spectacular use as a substitute for wool fibre is receiving some attention. However, commercial casein is not sufficiently unique and does not possess a constancy of quality which enables it to protect its markets from the encroachment of substitute products.

Lactose is made in commercial amounts for a limited market which will probably remain limited if the situation is allowed to remain as it is. Surplus milk and milk whey are dried and mostly used in animal feed. Both outlets are about the cheapest available, and force prices down to the level of many other competing agricultural wastes. The sale of evaporated milk is increasing but it utilizes only a relatively small part of the total surplus milk production.

The world is struggling for food—not for paper coating, or glue, or billiard balls, or even for clothing. Therefore, the most pressing human need for milk lies in the food field. Casein and lactalbumin are proteins that are the approximate equals of meat protein in human nutritive value. But there have been developed no widely attractive milk protein foods. However, there are soybean protein foods on the market. Lactose would seem to possess value in the structure of nerve and brain

tissue. Milk must have a unique significance, to a degree not heretofore recognized, in view of its being the one outstanding product made by nature to be a food when the growth demands of the animal are greatest.

Until products and markets are developed to take all milk as food, recourse must be had to the denaturation of milk for use in industries. It cannot be expected that the commercial uses of milk casein and albumin will be greatly expanded until we separate them into their indicated fractions, learn how to prepare them with fairly constant properties, and then explore the industrial field for uses of these specific products. Uncertain, inconstant mixtures do not find much acceptance in these days of technological constancy and dependability.

The industrial possibilities of lactose are indicated by the commercial development of calcium lactate, and the influence of the production of lactic acid by fermentation from milk whey on the forced improvement of lactic acid by fermentation from molasses. An annual market of about fifteen million pounds of organic acids for use in foodstuffs exists in this country alone, and lactic acid should have its share. Microorganisms are available that can bite, so to speak, into the lactose molecule to produce many different chemical products.

So the great milk industry need not consider itself checkmated in the great game of commercial competition. It is probable that milk is capable of being made into a greater number and a wider variety of different products than any other commodity in nature. Napoleon is reported to have said that the best defense against an enemy's fire is a well directed one of your own. In the same vein, the milk industry, knowing that it starts with nature's best product, can be assured markets that are ample in diversity and depth, provided that it fights to retain its present ones, and to develop new ones. It recognizes that it must know more about its own basic product, and then must aggressively seek to place it and its manufactured products where market surveys show that its properties are in demand.

Such an economic frontier of potential markets is not static. It changes as conditions change. These conditions are variable as our economic and commercial life progresses from one period to another. Therefore, we can expect that a commitment to an intensive program to develop new markets will require a continuance of such a program. Why? Because the job will never be completed—a given objective soon becomes the starting point toward another. Cessation of research aggressiveness means marketing retrogression.

J. H. S.

Proposed Amendments to the Constitution

Several proposed amendments to the Constitution of the International Association of Milk Sanitarians have been circularized to the membership by the Secretary-Treasurer. All provide that membership in the Association shall include subscription to the *Journal of Milk Technology*. The proposed amendments that were sent on August fifteenth are intended as alternates for those sent on June twenty-second. They provide for broadening the object of the Association by adding the development of improved milk technology, and disseminating information of value to milk sanitarians; they establish a professional status for milk sanitarians; and they provide for adding a new class of members whose qualifications are on the same level as those which have heretofore prevailed. The increased professional qualifications will not be retroactive on the present membership but are intended only for new applicants.

It is hoped that the entire membership will give these proposed amendments their careful consideration so that the discussion of their provisions at the Annual Meeting in Cleveland will throw light on all angles of the questions involved.

J. H. S.

A Glass Milk Bottle with Narrow Pouring Lip and Minimum Drip*

Lloyd Arnold, M. D.

University of Illinois College of Medicine, Department of Bacteriology and Public Health, Chicago, Ill.

Considerable confusion has existed in the rules of various public health agencies regarding the methods of enclosing the milk in a glass bottle. A review of this subject showed that there had been little scientific work done upon which to base enforcing regulations to protect milk properly. We undertook such a study in this laboratory.

Dearstynne and Ewing (1920) studied the bacterial flora on the lips of milk bottles. They found that some bottles of pasteurized milk, enclosed with flat disc caps, had 100,000 to 200,000 viable bacteria on the lip. They concluded that the bacteria deposited on the lip and cap were probably more dangerous than the bacteria in the milk inside the bottle.

Jackley (1922) called attention to the seriousness of lip contamination, because the poured milk contained these bacteria as well as the cap which acted as a bacterial reservoir to contaminate the milk continuously.

Rice et al. (1924) studied the bacterial flora in and on paper caps. Isaacs and Zeiben (1932) recorded the bacterial counts in milk capped with discs and hoods. They showed the former did not protect the milk as efficiently as the complete coverage afforded by the hood. Sansby and Halvorson (1936) described a new type of bottle neck design to protect the pouring lip with a relatively small metal cap.

STANDARD POURING MACHINE

We began this study with the objective of trying to ascertain the most suitable type of cap to use to enclose a glass bot-

tle of milk. It was necessary to define the area of the bottle to be covered or protected by a cap. We began our study by pouring milk from bottles by hand, and observing the behavior of the milk as it was pouring out of the bottle and over the lip. We were convinced that this method was unscientific, uncontrollable, and variable. It was impossible to duplicate the same identical conditions. We then designed a pouring machine to allow us to pour milk from several bottles of different design at the same time under identically the same conditions. The machine used for the major part of this work is shown in Figures 1 and 2.

We observed early in our work that the angle to which the bottle was rotated exercised considerable influence upon the behavior of the milk as it passed over the pouring lip. The first glass of milk is delivered from a full quart when the bottle is rotated from the upright or 0° to the 78° angle, and held in this position as long as the milk flows out of the bottle; the next glass of milk is delivered when the bottle is rotated from 78° to 84°. Table 1 gives in exact form the results of one hundred pouring experiments. It was found that when the full quart of milk was rotated from 0° to 78°, there was more surface area of the glass contacted by the milk than at any other angle. There was more drip at the 78° angle than at any other. Angles greater than 90° do not present pouring lip problems because the milk does not have an opportunity of contacting the lip in the same manner. Hence, we chose the 0° to 78° angle, or the first glass of milk pouring from a quart bottle as the best single pour to define the pouring lip.

*Aided by a grant from the Associated Milk Dealers Inc. of Chicago.

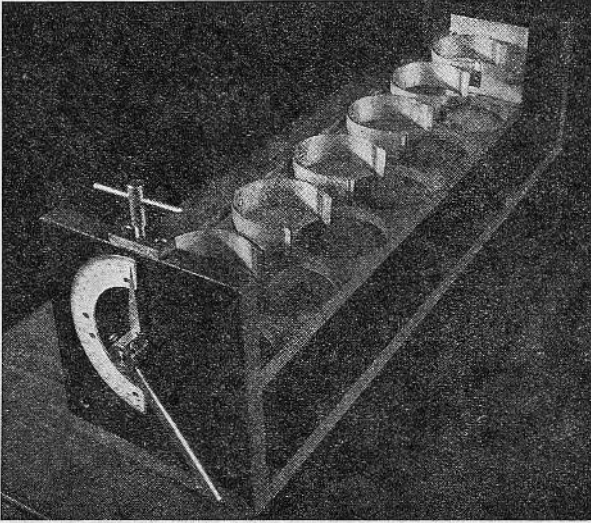

FIGURE 1.

This shows the standard pouring machine in an upright position ready to be loaded with six bottles for testing.

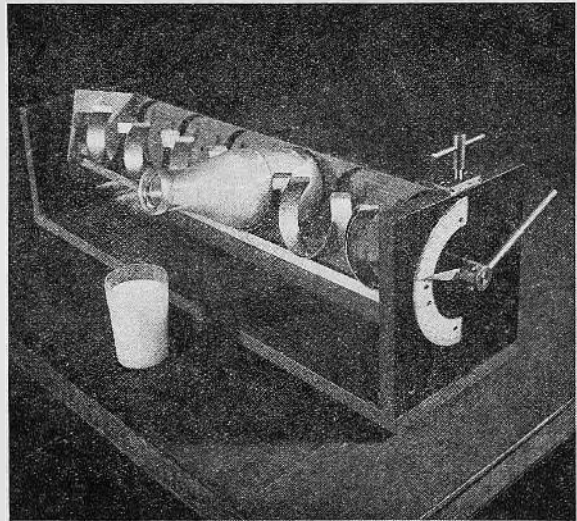

FIGURE 2.

This shows the standard pouring machine tilted to 78° angle and held in this position until one glass of milk is delivered from the bottle.

MEASUREMENT OF LIP CONTAMINATION

Our next problem was to find an indicator to use to aid us in determining the exact area of the glass of the bottle adjacent to the opening contacted by the milk during pouring. It is possible roughly to evaluate or classify bottles by observing, with the eye, the stream poured and the drip, but this is not accurate and is only useful for orientation purposes. We tried to use dyes and stains, but so far this has not proved successful. We had to use living bacteria applied to the glass surface as our indicator of the area of the glass contacted or covered with milk during pouring.

Some investigators have used quantitative methods in determining the bacteria washed off from the pouring lip of milk bottles. We were unable to do this. If bacteria are suspended or diluted in water or saline, and applied to a clean glass surface, the death rate is high because of the dessication factor. The number of living bacteria decreases with time. Therefore, counting the bacteria in the milk after it has passed over such a seeded surface would be variable unless correlated with the time of sojourn of the bacterial population on the glass surface. We used bacterial suspensions 1:100, 1:250, 1:400, 1:750 and 1:1000, and found none of these satisfactory because of the high death rates of the bacteria on the glass surface. Bacteria were suspended in egg white, gum acacia, milk, and other vehicles in order to protect them against dessication. The foreign materials altered the smooth glass surface and changed the pouring lip; hence, they

could not be used. We finally used a twenty-four hour old broth culture and applied this to the glass without dilution. The seeding was so heavy and the bacterial population so dense that even if fifty percent or more died, there were still several thousand (10,000 to 50,000) on the lip even after twenty-four hours.

Small tightly wound cotton swabs were sterilized and dipped into a twenty-four hour broth culture of *B. prodigiosus*. The excess fluid was pressed out by rotating the swab against the inside wall of the test tube which contained the culture. This swab was used to inoculate or mark the surface of the upper end of the glass bottle over which the milk was to be poured. The outside of the pouring lip including the upper part of the neck of the bottle was divided into horizontal, concentric anular zones from the top downwards. Each anular zone was usually approximately 1/4 inch. If for instance, six zones were to be studied, six bottles of the same type were washed, rinsed, covered with a paper extending down over two-thirds of the bottle, and tied with a strong string. The bottles were then autoclaved at 15 pounds pressure for 35 minutes. These bottles were then put in the dry air sterilizer to dry the paper and bottles. The paper wrapping was removed, and the sterile bottle was handled by holding it below the upper third. It was immediately filled with fresh fluid grade A pasteurized milk without touching the lip during the filling. The upper 1/4 inch zone on one bottle was then painted with a twenty-four hour old broth culture as indicated above, the sec-

TABLE 1

The average angles at which approximately 200 cc. of fresh fluid pasteurized milk are poured from a quart bottle. The pouring machine shown in Figures 1 and 2 was used.

Volume of milk		Angle of bottle in degrees	
In bottle Approximate	In glass Average amount	From	To
950 cc	204.5 cc.	0	78.07
750 cc.	204.3 cc.	78.07	84.3
550 cc.	207.0 cc.	84.3	89.7
350 cc.	208.5 cc.	89.7	96.9

ond zone of another bottle was similarly painted, and so on through the several zones of the six bottles respectively. Thus, there were six bottles, each with only one zone painted with our bacterial indicator. In other words, bottle No. 1 had only the upper $\frac{1}{4}$ inch zone contaminated.

These bottles were then put in the pouring machine as shown in the foregoing Figures 1 and 2. Sterile beakers were used to collect the milk poured. A sterile petri dish was put between the machine and the beaker to catch the drip. All six bottles were rotated from the 0° to the 78° angle, and were held in this position until all the milk that would pour at this angle, poured out. The bottles were then rotated from 78° back to the upright position. The drip is caught in the petri dish. The contents of the petri dish, or if excessive, 2 cc. of its contents, was used for bacterial examination in standard agar shake plates. Two cc. of the milk in the beaker were plated out in duplicate in the same manner. Agar plates were left at room temperature for forty-eight hours to allow growth and pigmentation of the *B. prodigiosus*.

We began our studies with autoclaved sterile milk. This had to be discarded because of the increased viscosity or cohesive forces of this milk. Our results could not be compared to fresh, fluid milk, but resembled milk with 10 to 15 percent butter fat content in so far as its behavior relative to the pouring lip was concerned.

EFFECTS OF FINISHES

We found considerable variation in the behavior of milk as it was poured by our standard method with bottles of different types of finishes. A careful study of our protocols convinced us we were dealing with the physical forces involved when a fluid is poured over a glass surface. The cohesive forces of fresh fluid pasteurized milk can be considered a constant. The variations in the configuration of the glass over which the milk was poured was the variable factor in these experiments.

Several examples of bottle finishes and the pouring lips as determined by our method are illustrated in the accompanying drawings. In order to convey to the reader the style of bottle corresponding to our type number, a drawing has been made of the neck and top of the respective bottles, together with an enlarged longitudinal section of the lip of each bottle with the zones touched or contacted by the milk during the pouring by our standard method. The bottles were not examined below the zones indicated.

The problem resolved itself into controlling the adhesive forces of the milk as it was poured over the glass surface. The smooth glass surface should be interrupted so as to break the film of milk adhering to it during pouring. A recess angle, or an annular ring around the top of the bottle, was tried to see if this would interrupt the film of milk adhering to the glass surface during pouring. It was found that this was effective, provided the angle was sharp and recessed at less than $\frac{1}{16}$ inch. Bottle No. 17 shows the behavior of milk poured by our method with the angle recessed only $\frac{1}{32}$ inch. It is obvious that this was not enough to interrupt the adhesive force of the glass surface. This bottle had an outside diameter of 54 mm.

Bottle type No. 19 (56 mm.) is similar to No. 17 except that the recesses are $\frac{1}{16}$ inch in depth. The results as shown in the accompanying diagrams indicate this bottle finish reduced the area of the glass in contact with the milk during pouring.

Bottle type No. 19 was made up in four different designs—the usual form with and without the seat cap, and the cream top finish in the same design with and without the seat cap. There were no detectable differences in the behavior of poured milk in these four varieties of type No. 19 finish.

Bottle type No. 14 ($56\frac{1}{2}$ mm.) is a slightly different design, but the collar of glass just below the second recessed angle would interfere with capping, and accordingly was considered objectionable.

LEGEND

The behavior of milk poured with use of the Standard Pouring Machine indicated by the number of times the milk contacted the respective zone during the pouring is recorded for each type of bottle tested. The zones indicated on the drawings and the percent figures are based upon one hundred pouring tests. Each type of bottle is indicated by the respective numeral inside the bottle neck.

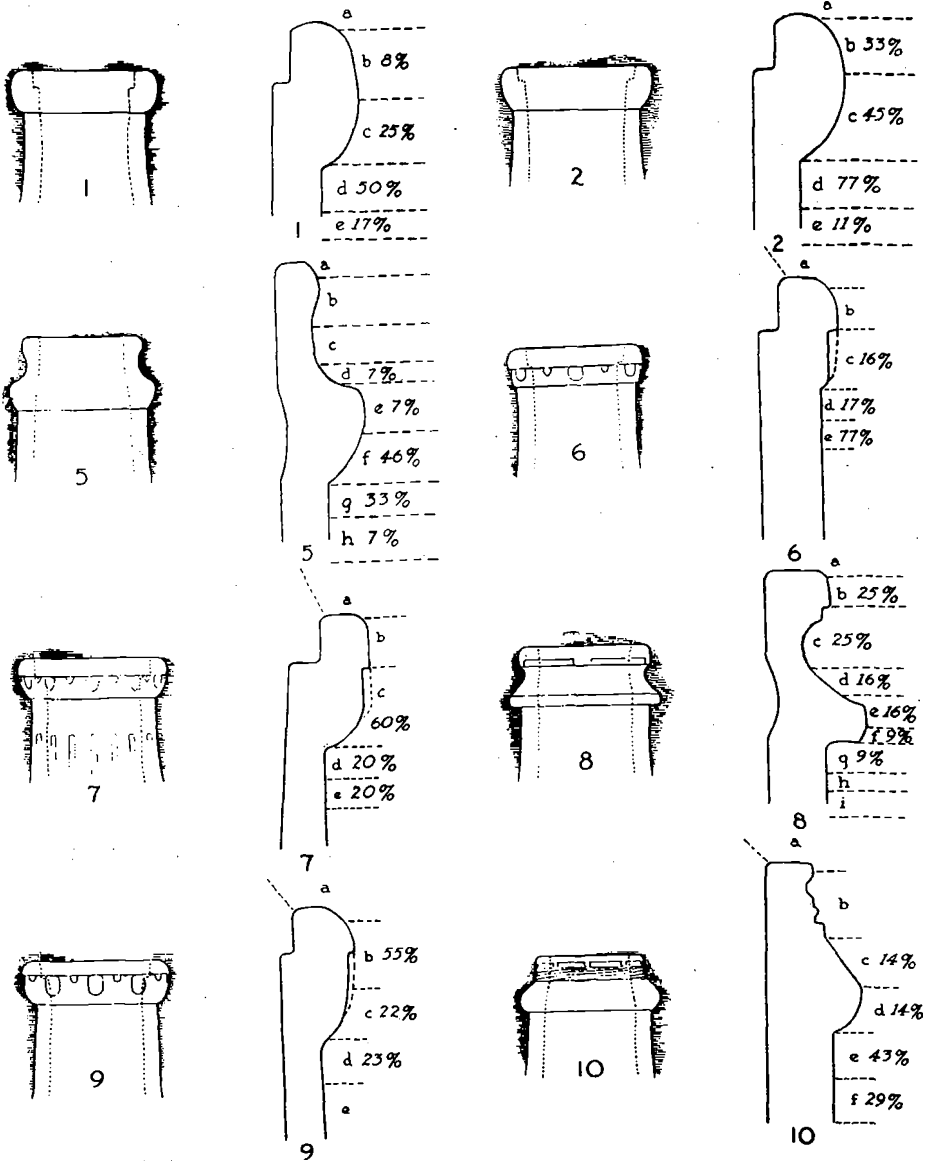

LIP CONTAMINATION OF MILK BOTTLES

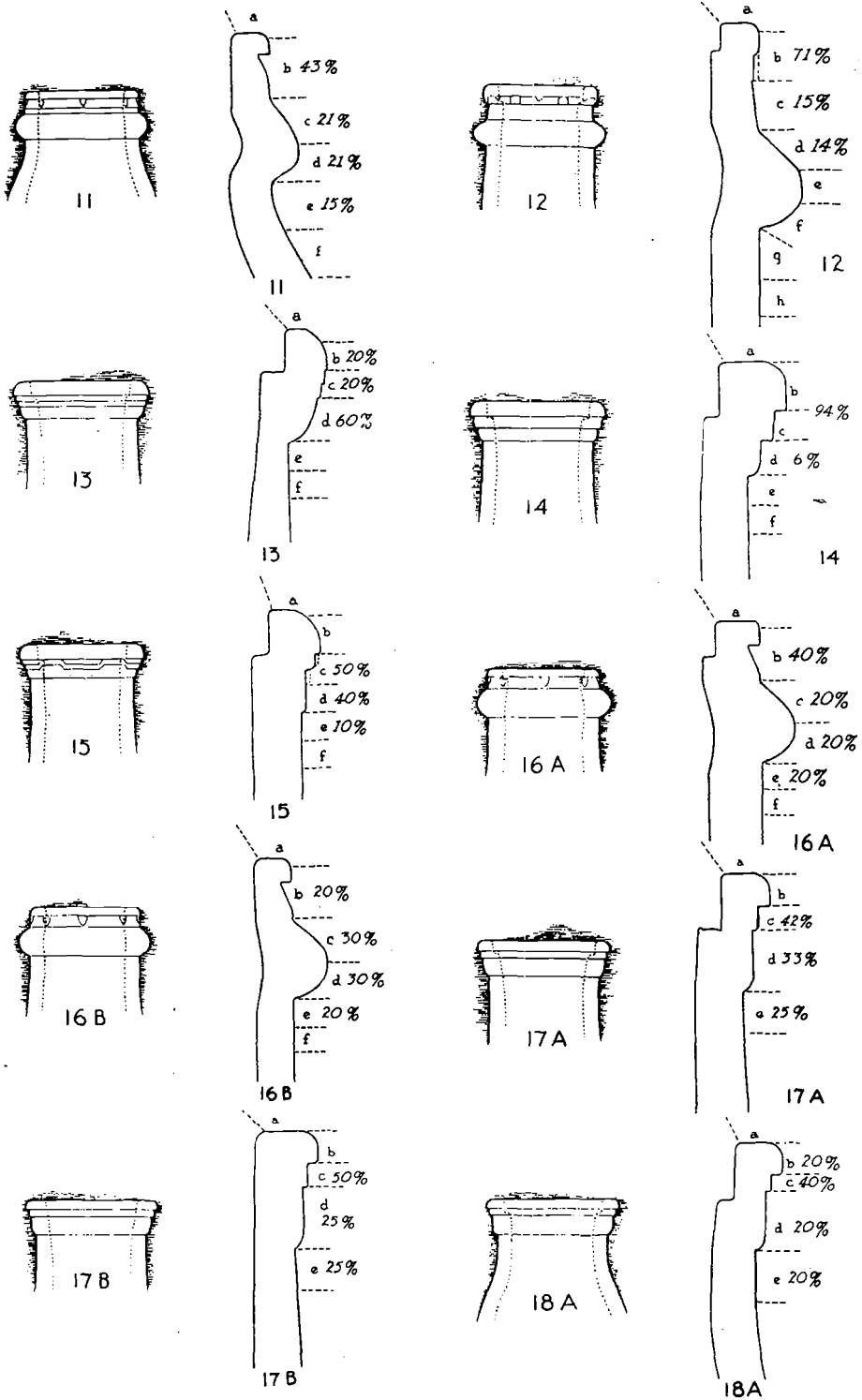

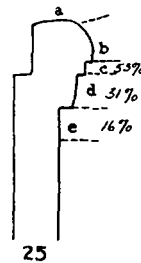
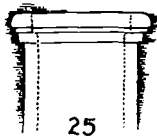
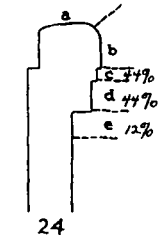
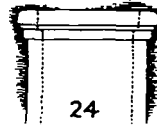
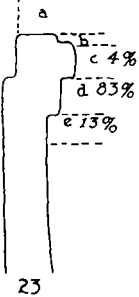
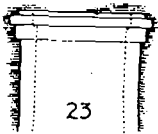
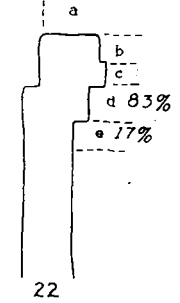
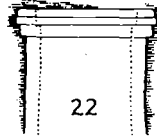
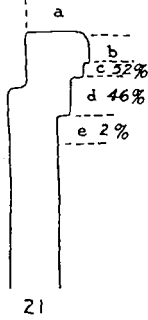
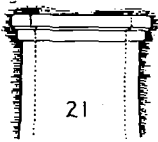
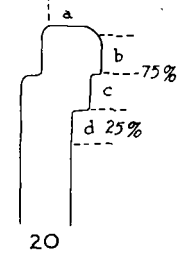
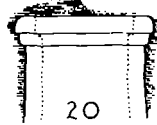
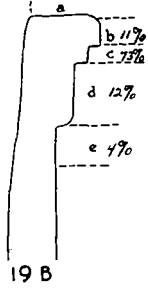
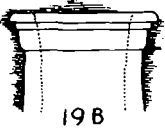
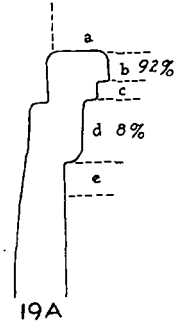
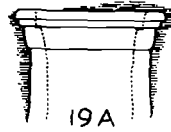
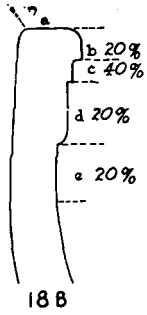
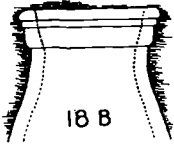

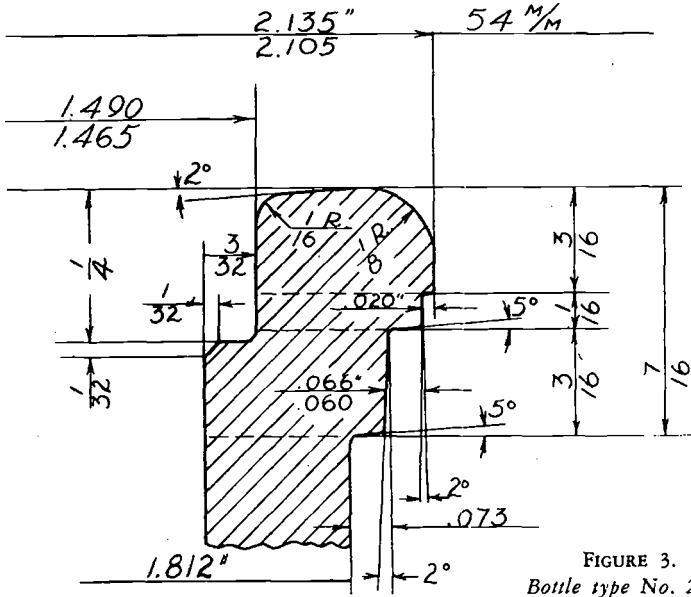

FIGURE 3.
Bottle type No. 21-A
54 mm. finish
Number 4 Cap
(Scale 3" = 1")

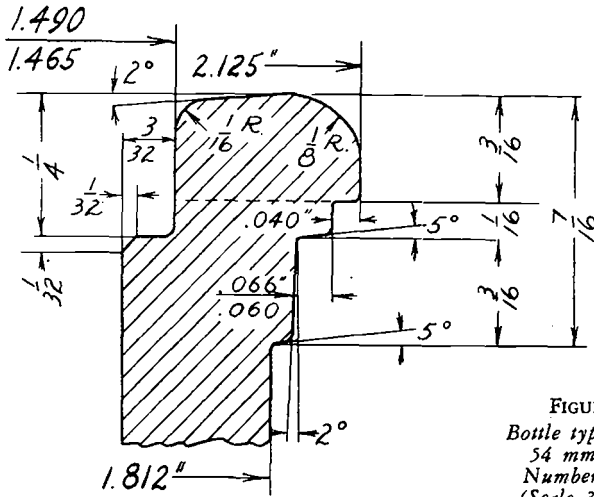

FIGURE 4.
Bottle type No. 31
54 mm. finish
Number 4 Cap
(Scale 3" = 1")

Bottle type No. 20 is similar in design to type No. 14.

Bottles of types No. 22 and No. 23 have one protruding angle each located near the top of the bottle. The diagrams showing the results of our experiments indicate that this principle is not as effective in reducing the adhesive forces of the milk poured as recessed angles.

Bottle type No. 21 (55 mm.) is the best design we have been able to develop so far in our work. The top surface of the bottle is flat, the first recessed angle is $1/32$ inch. This angle is $3/16$ inch below the top of the bottle. The second recessed angle is $1/16$ inch, and placed $1/16$ inch below the first angle. The third recessed angle is $3/32$ inch placed $3/16$ inch below the second angle. Considerable experimentation was necessary to arrange these angles to the greatest advantage. The first recessed angle, reinforced by the second deeper recessed angle, reduces the pouring lip to $1/4$ inch below the top of the bottle. The lower angle prevents drip of the drop or two of milk passing the second angle when the bottle is returned from the 78° angle to the upright position. The cap should completely cover all three angles, extending down below the last angle or $7/16$ inch from the top of the bottle.

Bottle types No. 24 and No. 25 represent our efforts in making slight alterations in the dressing of the type No. 21. The main purpose was to make the horizontal flat top surface less sharp on the margins, and to elevate the outer margin so as to avoid possible chipping of the inner margin adjacent to the seat cap. The results given in the diagrams show that these finishes were not so satisfactory as that of No. 21. The flat top (zone A) played a greater role in the behavior of the milk poured from the bottle than had been suspected or considered.

We have worked with type No. 21 for six weeks in our laboratory. We ordinarily do twenty complete pouring experiments with each bottle to be tested. Type No. 21 has been used for one hundred and forty-two (142) complete pouring

tests, involving the testing of four hundred and twenty-six (426) bottles. The results are indicated in the diagram.

Another glass bottle manufacturer has molded this bottle from the blue print sent him. The pouring experiments gave identical results as was obtained with the first design made at my suggestion.

Bottle type 21 A (54 mm. diameter) does pour as well as the 55 mm. (No. 21) with the same design. The zone below the lowest recessed angle showed contact with the milk one time in ten pours.

Bottle type No. 31 (54 mm. diameter) differs from the 21 A type in that the first angle recesses 0.04 inch instead of 0.02 inch. The second recessed angles are the same on both bottles. The lower angle on the No. 31 is very shallow. It will be difficult to close this type No. 31 with a seal, because of the absence of a shoulder of glass of sufficient mass to encase properly. This bottle is the best we have so far tested. Sixty-five pours have been made using the standard pouring apparatus, and the zone below the last angle was not contacted by milk in any instance. The zone between the middle and last recess angles was contacted by the milk in one pour in five. In other words, the first and second angles were effective in eighty percent of our experiments; the next zone was in contact with the milk in twenty percent of our tests. The zone below this third recessed angle was not in contact with the milk during or after pourings.

The detail drawings of these two finishes (No. 21 A and No. 31) are shown in Figures 3 and 4. The principle of breaking the adhesive surface of the glass by recessed angles is well illustrated in these two drawings.

The overall top diameter of the type No. 31 bottle should be reduced to 51 mm. or less. The distance of the last recessed angle from the top of the bottle should also be reduced. Experienced glass manufacturers state that 54 mm. is the narrowest overall size they can make at this time. It is believed that such a bottle will not have the proper strength

if the dressing is reduced to less than 7/16 inch from the top in the presence of a seat cap depression on the bottle. The presence or absence of the cap seat does not influence the pouring lip of the bottle. It may be possible to reduce the area occupied by the three annular rings or recessed angles if the cap seat is eliminated. It would be possible to reduce the size of the cap if the diameter were reduced and the external recessed angles placed closer together.

The design described above can, of course, be put on bottles of larger diameter. The 56 mm. diameter and larger sizes should be easier to make, because there is more glass to work with in molding the dressing.

The pint and half pint size bottles should have the same dimensions. The outside diameter of the neck of a quart bottle below the dressing is 1.812 inches. The pints and half pints have an overall neck diameter of 1.750 inches. In order to utilize the mechanical capping equipment, it is suggested that the area below the last recessed angle on the small size bottles be held at 1.812 inches outside dimension for at least 1/4 inch, and then recessed to 1.750 inch diameter. This would permit the same mechanical equipment to be used on all sizes of glass bottles.

SUMMARY

A standard pouring machine for milk bottles, and a standard technique for determining the behavior of milk poured from glass bottles have been described.

The degrees of bacterial contamination obtained from bottles of different finishes have been measured.

Experiments with a new type of finish involving recessed angles to interrupt the adhesive force of the glass surface have been described. The pouring lip has been reduced to 7/16 of an inch from the top of the bottle so that there is a minimum of milk drip during the pouring.

REFERENCES

- Dearstyne, Roy S. and Ewing, C. LeRoy: Number of Bacteria on the Lips of Milk Bottles and Their Significance. *Am. Journal Public Health* 1920, 10:533-535.
- Isaacs, M. L. and Zeiben, I.: A Comparative Study of Milk in Bottle with Single and Double Caps. *Am Journal Hygiene* 16: 806-822, 1932.
- Isaacs, M. L. and Zeiben, I.: *Am. Journal Hygiene* 16:806.
- Jackley, J. G.: The Danger of Improperly Capped Milk Bottles. *Journal Dairy Science* 1922, 5:406.
- Rice, J. L. Van Saun, Anna I, and Haywood, Katherine E. Advocating Bacterial Counts on Milk Bottle caps with a Comparison of the Effect of Different Methods of Capping on Such Bacterial Counts. *The Nation's Health*, 1924, 6:325-327.
- Rice, J. L. Van Saun, Anna I., and Haywood, Katherine E. Bacterial Counts on Milk Bottle Caps with a Comparison of the Effect of Different Methods of Capping on Such Bacterial Counts. *Abs. Bact.* 8 (1): 15-20, 1924. (*Rec. Expt. Sta. Rec.*, 1924, 51:778).
- Sansby, J. Martin and Halvorson, H. O. Contamination of Pasteurized Milk: Including Bacterial Study of the Milk After it is Poured from Bottles Contaminated with *B. coli*. Presented in part at a meeting of the Milk Sanitary Advisory Board, United States Public Health Service, Washington, D. C., May, 1936.

A Study of a Scarlet Fever Epidemic at Rockford, Illinois*

C. W. Anderson

Director of Laboratories, Rockford Department of Public Health

and

S. V. Layson

Milk Sanitarian, Illinois Department of Public Health

The city of Rockford, Illinois, with a population of 90,000 has had a compulsory pasteurization ordinance since 1932. However, economic conditions have caused the city to become surrounded with cash-and-carry milk stations, located just beyond the city limits, to which customers take their own containers to be filled with dipped raw milk. State laws prohibit the sale of pasteurized milk by this method but there are no regulations governing the raw product except in the case of emergency, such as an epidemic. The jurisdiction of city health authorities does not extend beyond city boundaries.

The stations undersell the pasteurizing plants three to four cents a quart. Sales are not limited to homes in the lower income brackets. Expensive cars with liveried chauffeurs are not infrequently seen getting their milk supplies at the stations. The milk has that old familiar (cow manure) flavor to which they were accustomed back on the farm.

A sudden increase in the reported cases of scarlet fever during the last week of March 1937 caused the health officer of Rockford to give special attention to all cases. Their localization to a residential section on the north side of the city (Map 1), and multiple cases in homes indicated a common source of infection. Close scrutiny of case histories revealed that Milk Station A was the source of milk supply in a large percent of the homes involved. This station was selling 220 quarts of dipped raw milk and 340 quarts of bottled pasteurized milk secured from an approved pasteurizing

plant. It seems significant that all cases among the customers of this station were using its raw milk and none the pasteurized milk exclusively.

A review of the incidence of scarlet fever in Rockford during the past ten years compared to 1937 will give a background for the present study. Chart No. 1 gives a ten-year monthly average compared to the number of cases for 1937. Referring to the chart it can be readily seen that during the months of January, February, March, May, and June the incidence of scarlet fever was considerably below the ten-year average while the large increase in April over the average was due to the epidemic in that month.

The first case using this supply became ill March 13 as shown on Chart No. 2, and a sister of case No. 1 on March 16. No contact or source other than milk could be established for these two cases.

During the week of March 21 to 27, the attention of health authorities was focused on Station A when eleven cases, all users of Station A dipped raw milk, were reported.

Investigation of one case reported on March 27 revealed a factory worker, who to augment his income, worked nights and on holidays as clerk in Station A. Onset of this case had been with a sore throat March 23, the last night he was on duty. He was a milk drinker and used Station A raw milk in his home. At first, this case was thought to have been a factor in causing the epidemic but it later appeared more probable that he became infected by drinking the raw milk. His nineteen year old sister was reported as a case on March 31.

* Read before International Association of Milk Sanitarians, October 13, 1937, Louisville, Ky.

SCARLET FEVER EPIDEMIC AT ROCKFORD

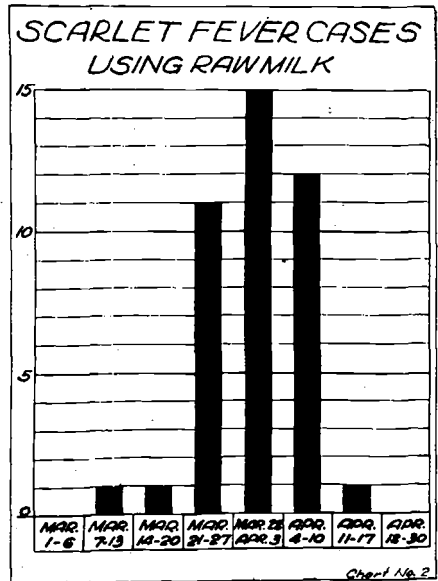
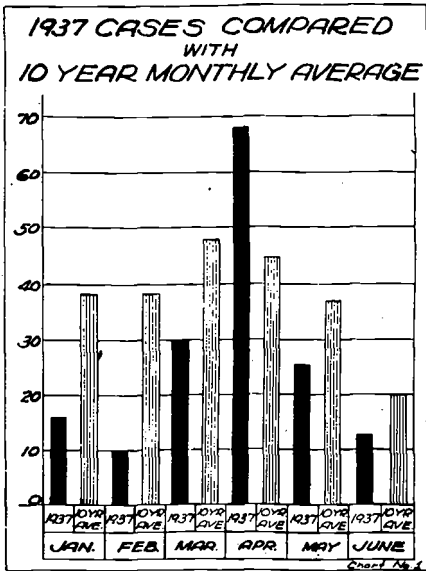
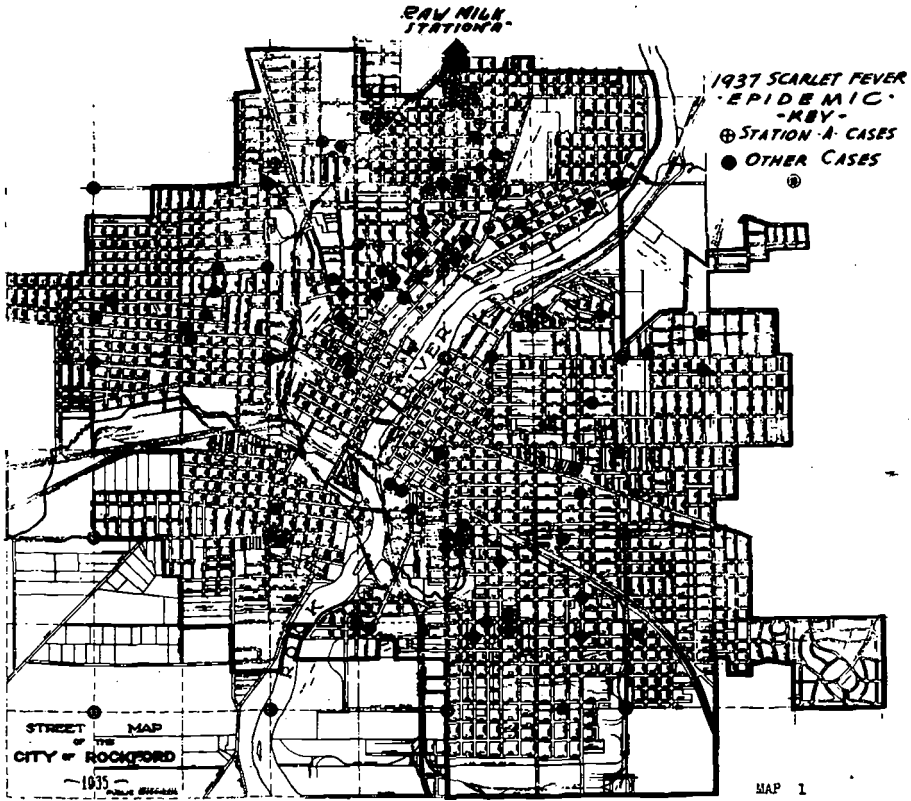

The following week, March 28 to April 3, the suspicion of health authorities was strongly confirmed by the occurrence of fifteen additional cases using this raw milk supply. The evidence was believed sufficient to warrant closing the station which was done on April 3. Twelve more cases developed during the week of April 4 to 10 and only one the following week of April 11 to 17. This single case was evidently a contact from a case reported April 2. Allowing the usual incubation period, it seems probable that the epidemic had been stopped by the closing of Station A.

The epidemic period extended from March 23 to April 9 during which time a total of 48 cases occurred, one case resulting in death. The cases were evenly divided between male and female. Those of school age were scattered throughout nine schools, the highest number in any one school being seven, all of whom were users of Station A raw milk. A total of 41 cases were users of this supply.

It is reasonable to assume that where cases of scarlet fever are due to chance contact, the number of cases occurring among customers of a large dairy would be relatively greater than those occurring among customers of a small dairy. This relationship is brought out in Chart No. 3. The first column shows that 41 percent of all cases occurring in Rockford during March and April were due to Station A dipped raw milk, whereas the volume of this milk distributed was only 0.7 of one percent. No cases occurred with Station A pasteurized milk which amounted to 1.1 percent of the total supply. The largest pasteurizing plant B (see Chart No. 3) which distributed 29.4 percent of all the milk consumed in Rockford had 17.1 percent of the cases during this 60 day period. A comparison of the remaining plants is shown.

The next, Chart No. 4, also brings out the relationship between number of cases and volume of distribution. In this chart, however, the cases have been computed on the basis of number of cases developing for each 10,000 quarts of milk

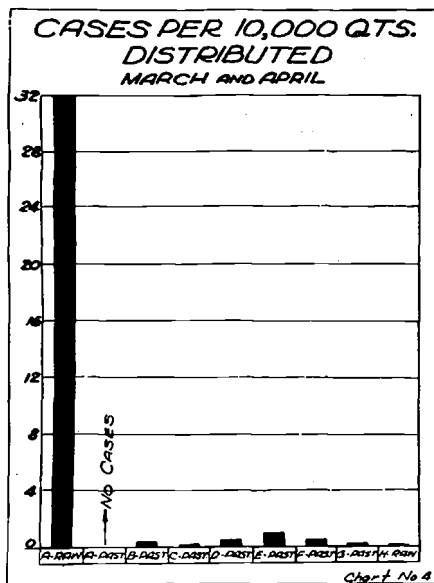
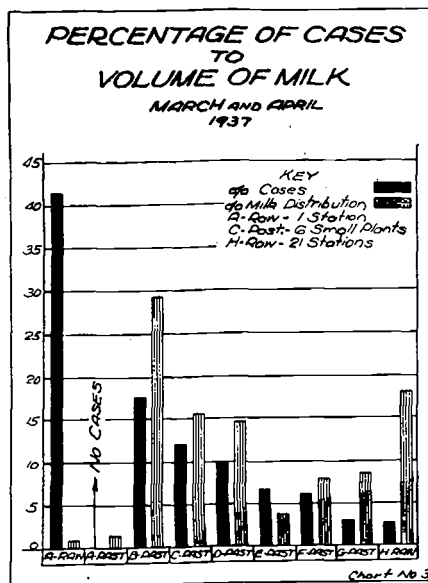

distributed by the various plants during the 60 day period. This chart would seem to indicate that the element of chance contact played a very minor role in the case of Station A dipped raw milk.

As first step in tracing the epidemic, composite samples of milk were collected

from all stations selling raw milk. Blood agar plates were made to determine whether hemolytic streptococci were present in significant numbers, such as 1,000 per cubic centimeter¹. About 30 percent showed 100 or more hemolytic streptococci per cc. Typical colonies picked from these plates were tested for their ability to hydrolyze sodium hippurate. The specimen from Station A was the only one negative to this test. The failure to hydrolyze sodium hippurate was taken as presumptive evidence that the organism resembled those of human origin.

As a means of differentiating human strains of beta hemolytic streptococci from those of bovine origin, Coffey² states that the following biochemical characteristics are of considerable value, namely, final hydrogen ion concentration of 4.6 or above in one percent dextrose broth, a positive fermentation of trehalose, negative fermentation of sorbitol, and failure to hydrolyze sodium hippurate. The same author further states that the group-precipitation procedure is also necessary as it serves to differentiate not only strains which may be distinguished by the above biochemical properties but also those

which resemble human pathogens in these activities but are of little significance in disease in man.

Composite herd samples were taken from the four producing farms supplying Station A. Samples from Herds No. 1 and No. 2 were negative. Those of No. 3 and No. 4 were positive for hemolytic streptococci. Individual cow samples were then taken from these two herds. Herd No. 3 consisted of 28 cows, 25 of which were Bang's reactors and had been branded as such for more than a year. Eight of these cows had varying numbers of hemolytic streptococci. Although quarter samples were taken of these eight cows, no strains resembling human pathogens were recovered. Herd No. 4 consisted of eleven cows, and it was found that cows No. 4, 5, 6 and 8 had hemolytic streptococci in considerable numbers. Quarter samples were taken on these four cows and the differential tests were applied on all strains isolated. The Table No. 1 shows that one member of the herd known as Bessie (No. 6) had a very large number of hemolytic streptococci in two quarters, 51,000 and 95,000 per cc. in the right front and left

TABLE 1

Results from examination of milk of individual cows in infected herd

	Number Hemolytic Strep. per cc.	Hydrolysis of sodium hippurate	pH in Dextrose Broth	Trehalose	Sorbitol	Mannitol	Lactose	Salicin
Cow No. 4 Left Front Quarter	3,000	Pos.	4.4	Pos.	Neg.	Neg.	Pos.	Pos.
Cow No. 5 Left Rear Quarter	18,000	Pos.	4.5	Pos.	Neg.	Neg.	Pos.	Pos.
Cow No. 6 Right Front Quarter	51,000	Neg.	4.7	Pos.	Neg.	Neg.	Pos.	Neg.
Cow No. 6 Left Front Quarter	95,000	Neg.	4.7	Pos.	Neg.	Neg.	Pos.	Neg.
Cow No. 8 Right Front Quarter	2,000	Pos.	4.5	Pos.	Pos.	Neg.	Pos.	Pos.
Cow No. 8 Right Rear Quarter (Bad)	2,000	Pos.	4.5	Pos.	Pos.	Neg.	Pos.	Pos.

front quarters respectively. There was no clinical evidence of infection. The strains isolated from both quarters fermented trehalose, failed to ferment sorbitol or to hydrolyze sodium hippurate, and gave a pH of 4.7 in 1 percent dextrose broth. The biochemical properties of these organisms indicated human pathogens.

Cultures of the strains isolated were submitted to the Referee of the A.P.H.A. committee for further identification by the group-precipitation test.

The samples of milk, from which the submitted cultures were obtained, were collected more than a month after the epidemic occurred. The test indicated that the beta hemolytic streptococci isolated from Cow No. 6 were of the C-G group.

The referee stated that in other outbreaks of streptococcus infection which had been studied, the organisms isolated from patients had been in Group A. Considering this fact alone, it might eliminate Cow No. 6 as a source of the epidemic. However, the number of outbreaks studied is rather limited, and the toxigenic activity of some strains in group C-G from sources other than man or milk has been established.

In view of the fact that more than a month had elapsed from the onset of the epidemic and the time the organisms were isolated, it is possible that Group A organisms, which may have been present in the udder during the epidemic, were supplanted by strains in Group C-G. This occurred in the case of Cow No. 3007 reported in Table 2 of the A.P.H.A.

Yearbook 1936-37². The successful isolation of Group A strains from a cow's udder apparently requires that the milk specimen be obtained promptly during the course of the epidemic or immediately afterward.

The facts presented can not be taken as conclusive evidence that Cow No. 6 was the source of the epidemic, but circumstances indicate such was the case.

How did Cow No. 6 become infected? Mr. B, a tenant on Farm No. 4 assisted with the milking daily until February 21 on which date illness of his five year old daughter was diagnosed as scarlet fever. She had been ill two days when seen by the family physician, placing onset February 19. Mrs. B, the mother, had been ill with acute tonsilitis on February 17. (Due to impassable roads the family was practically isolated during February and early March). A younger daughter developed a sore throat with rash and temperature on March 14 and was ill for three weeks. Unfortunately, no cultures were obtained from these cases at the time they occurred and there may be no connection to the epidemic but again circumstantial evidence indicates a possible chain of contact.

REFERENCES

1. Williams, Anna W.; "Streptococci in Relation to Man in Health and Disease", Chapter VIII, p. 162.
2. Coffey, Julia M., Referee; "Tentative Methods of Isolation and Identification of Hemolytic Streptococci", American Public Health Association Year Book, 1936-37, pp. 135-138.

Problems Related to Homogenized Milk*

F. J. Doan,

Dairy Department, The Pennsylvania State College, State College, Pa.

The homogenizer was first used in the dairy industry for preventing fat separation in evaporated milk. Some years later it was found almost essential in the production of smooth-textured ice cream. Today it is being used in the processing of a great variety of manufactured products and also fluid market milk. For the treatment of fluid milk for retail sales, the homogenizer has not been used extensively, although there is much interest among milk dealers in its possibilities, particularly from the viewpoint of producing a milk of low curd tension and improved digestibility.

Homogenizers have undergone several changes since their first development. Most of these have had to do with three things: the development of a more efficient homogenizing valve or aperture, improved mechanical operation, and better sanitary features. At present the common form of homogenizer is a three piston pump operating against a ground drop and lift valve. Newer models are constructed so that every part contacting the milk can be taken apart and easily cleaned. Even the pistons are capable of being removed for washing purposes.

Rotary machines, operating on the principle of a gear or Bump pump, developing lower pressures and utilizing less power, have been developed over the past five years. Some of these machines have very elaborate homogenizing valves or jets, the idea of their designers having been to compensate the necessarily lower pressure with a more efficient valve. In this they have apparently partially succeeded. These machines are highly sanitary in construction and no doubt influ-

enced recent sanitary changes in the piston machines.

Sonic homogenization is accomplished with equipment acting on a different principle. Milk is conducted between diaphragms oscillating at high frequency, the effect on the product being very similar to that of the pressure homogenizers although no pressure is utilized. Apparently the violent vibration produced in the milk causes a break-up of the fat globules.

In general, the efficiency of any homogenizer (sonic excepted) depends on the velocity with which milk is caused to go through the constricted aperture which constitutes the homogenizing valve or jet, the force which it impinges on the chamber wall surrounding the valve, the number of such apertures it goes through, and perhaps the degree of staggered flow produced. This explains the existence of two and three stage valves, and the other complications frequently encountered in homogenizing valves. Several years ago, studies at Pennsylvania State College with single valves of the drop and lift type indicated that maximum efficiency results when the valve construction causes the milk to strike the wall of the chamber as nearly at right angles as possible, and when the distance from the valve seat to such wall is short. Most modern homogenizers are equipped with valves having these features.

THE EFFECTS OF HOMOGENIZATION ON MILK

Homogenization causes certain changes in the physical and chemical properties and characteristics of milk. For the most part, these changes are proportional to the fat content of the milk, the more fat present the greater the change. That fat plays a predominant role in the effects of homogenization is readily seen when it is con-

*Presented before the Metropolitan Dairy Technology Society, New York, N. Y., April 19, 1938.

Authorized for publication on July 13, 1938, as paper No. 842 in the Journal Series of the Pennsylvania Agricultural Experiment Station.

sidered that up to the present time no one has shown that homogenization of skim-milk produces any measurable change in the product.

The most evident change in homogenized milk is the greater number and smaller size of the fat globules as shown in Table 1. Globules with an average diameter under about 2.75 microns will not rise to such an extent as to show evidence of creaming in milk held for 48 hours. When the average size is reduced to about 1 micron, even centrifuging and analyses of the upper and lower layers reveal only small differences in the fat content.

The reduced size of the fat globules in homogenized milk makes it practically impossible to recover the fat by separation. Whenever the pressure exceeds 1500 lbs. per sq. in., the fat in separator skimmilk will be in the neighborhood of one per cent. This interferes with the easy disposal of returned goods, and constitutes one reason for dealers hesitating to go into production. Homogenized milk or cream will not readily churn. This is an advantage in decreasing the possibility of cream plug, grainy texture, and oiling-off, but again prevents easy recovery of the fat in the surplus product.

The viscosity of homogenized milk is higher than unhomogenized. This gives the product a richer flavor. This effect is not great unless the fat content is increased to 5 or 6 percent.

The alcohol test indicates that milk is more easily coagulated after homogenization, and the same results are obtained with rennin and acid. The explanation probably lies in the greater amount of adsorbed casein on the expanded amount of fat globule surface. Such casein is fixed. It has lost its mobility and that is one of

the first stages in coagulation. The instability of homogenized milk toward coagulation becomes more pronounced with higher fat content.

The surface tension of milk is increased very slightly by homogenization, but the effect becomes quite definite at fat levels of over 6 percent, when the property is measured with the DuNuoy instrument.

The specific gravity of milk is not appreciably affected by homogenization, so long as the machine and the suction line are air-tight, but, if air is sucked into the milk in the processing, the specific gravity may be reduced considerably, at least temporarily.

The curd tension of milk is reduced very greatly by homogenization, as shown by many investigators. The effect increases with the fat content of the milk and the pressure or efficiency of homogenization. Table 2 contains a set of typical data obtained in the writer's laboratory. The data indicate that pressures over about 2000 lbs. per sq. in. accomplish little with average milk, although with milk of high fat content (standardized), greater reductions are obtained with higher pressures. They also show that the percentage reduction is least with naturally soft curd milk and greatest with naturally hard curd milk. Two-stage processing apparently has no advantage over single stage in lowering the curd tension of average fluid milk.

It is well known that temperatures of preheating, pasteurizing, and processing influence curd tension. This heat factor, however, is not of great importance until the heat considerably exceeds that of pasteurization. Nevertheless, the effects of heating and homogenizing are difficult to divorce completely.

TABLE 1.
Effect of Homogenization on Fat Globule Break-up

	Treatment of Pasteurized Milk	Diameter of Fat Globules (microns)
Unhomogenized	4.21
Homogenized at 500 lbs.	3.34
" " 1000 "	2.61
" " 1500 "	2.38
" " 2500 "	1.67
" " 3500 "	1.13

TABLE 2.
Effect of Homogenization on Curd Tension

Treatment of Pasteurized Milk	Curd Tension (grams)*		
	5.1% fat	4.2% fat	3.6% fat
Unhomogenized	123	56	34
Homogenized— 500 lbs. at 145° F.	72	44	29
“ 1000 “ “ “ “	58	27	20
“ 2000 “ “ “ “	37	18	14
“ 3000 “ “ “ “	38	19	12
“ 4000 “ “ “ “	40	17	12
“ 1000— 500 lbs. at 145° F.	60	28	20
“ 2000— 500 “ “ “ “	41	17	15
“ 3000—1000 “ “ “ “	42	17	11
“ 3000— 500 “ “ “ “	39	19	13

*Curd tension determinations were made using Miller's technique with several modifications in manner of mixing sample and coagulant (0.3% HCl and 0.45% pepsin). [Editor: See J. Dairy Science 18, 259 (1935)]

While homogenization of cream and ice cream mix usually results in a clumping of the fat globules as well as a reduction in their size, the effect is not significant in fluid milk. Fat clumping does not occur until the fat content exceeds about 6 percent. It is the fat clumping phenomenon which causes such noticeable changes in the alcohol stability, the viscosity, the surface tension, and to some degree in the curd tension. It is also this phenomenon which makes the two stage valve of such value in reducing viscosity and increasing stability. When fat clumps are absent, a second valve produces little or no effect.

OTHER EFFECTS OF HOMOGENIZATION

Homogenization produces certain other changes in milk, some of which constitute troublesome problems to the manufacturer, and many of which are not thoroughly understood.

If milk is homogenized without previous heating or immediate subsequent heating to a temperature in the neighborhood of 140°-150° F., an enzyme, lipase, which is always present in mixed milk, will attack the fat and cause a characteristic rancid flavor. The mechanism of this reaction is not understood, but presumably the adsorbed layer on normal fat globules acts as a protective membrane against the enzyme. Homogenization destroys this coating, and exposes new fat surface. The lipase is adsorbed with other substances to form a new membrane. This brings it into intimate contact with the fat. Critical

preheating temperatures for inhibiting rancidity in homogenized milk have been found to be 148° F. flash, 137° F. for 15 minutes holding, and 132° F. for 30 minutes, applied either before or immediately after homogenizing. In unpreheated milk, rancidity can usually be detected within 30 minutes following homogenization, especially when high pressures are used. The liberation of fatty acids causes a drop in surface tension and in pH, and an increase in titratable acidity. The reaction can easily be followed by determining these values at intervals. Because of lipase action, it is impossible to produce an homogenized raw milk.

Tallowy or oxidized flavor has been very troublesome in market milk for some years, and is still an important problem. While the reaction causing tallowiness is not absolutely known, it appears to be an oxidation of the fat or the lecithin or probably both. Some consider it an enzyme reaction. Others believe that it is probably a non-biological, physico-chemical catalysis wherein several agents may act as catalyzers such as light, copper, and other pro-oxidants; or a lack of normal anti-oxidants from feed sources may cause the same result. Whatever the reaction is and whatever it may be due to, or accelerated by, we now know that homogenization will definitely delay its appearance or even prevent it if the homogenizing pressure is sufficiently great. This statement has one exception. If the tallowy flavor is induced by sunlight, homogenization is no protection. On the con-

trary, homogenized milk is more sensitive to sunlight than unhomogenized milk, so that dealers offering homogenized milk to their trade would do well to keep this fact in mind. If homogenized milk can be protected from sunlight, other causes of tallowy or oxidized flavor may be forgotten as far as this product is concerned. It has been suggested that homogenized milk be retailed in green glass bottles or protected by green Cellophane wrappers. Such treatment will efficiently protect homogenized milk from the effects of exposure to sunlight. Data dealing with homogenization and tallowy flavor are given in Table 3.

In the first portion of the table, the data show that homogenization of milk at pressures of 2000 lbs. or over prevents oxidation in milk treated with copper. In the second portion of the table the data indicate the value of green as a protective color both for unhomogenized and homogenized milk. They also illustrate the

greater susceptibility of homogenized milk to sunlight. Finally, in the case of sample 16, it is shown that paper containers are not measurably superior to clear glass in protecting milk from the effects of sunlight.

Homogenization of milk tends to agglutinate particles of fine dirt, bacteria, and cellular elements in milk, and to cause them to settle, forming a grayish sludge which in a milk bottle is unsightly. This material in normal milk is apparently swept up with the rising fat globule clusters, and is unnoticed in the cream layer. The amount of sedimentation caused by homogenization depends on the condition of the milk, i. e., the amount of sediment and cells present, and to a lesser degree on the pressure used. Filtration of the milk, either before or after homogenizing, does not reduce the sedimentation since most of the material responsible will readily pass through a filter. Clarification, however, will effectively eliminate any visible sedi-

TABLE 3.

Treatment of Pasteurized Milk		Degree of Tallowy Flavor	
		24 Hours	48 Hours
<i>Copper Treated</i>			
1.	Unhomogenized—untreated—check	none	none
2.	Unhomogenized—treated with 3 p.p.m. copper.....	++	++++
3.	Treated 3 p. p. m. copper—Homogenized 500 lbs.	++	+++
4.	" " " " " " " 1000 "	none	+
5.	" " " " " " " 2000 "	none	none
6.	" " " " " " " 3000 "	none	none
<i>Exposed to Sunlight (30 min.)</i>			
1.	Unhomogenized—Exposed in opaque glass.....	none	none
2.	" " " " " clear glass.....	+	++
3.	" " " " " green cellophane wrapper	none	none
4.	" " " " " blue wrapper	none	±
5.	" " " " " yellow wrapper	+	++
6.	" " " " " red wrapper	±	+
7.	Homogenized 500 lbs.—Exposed in opaque glass	none	none
8.	" 3000 " " " " clear "	none	none
9.	" 500 " " " " clear "	++	+++
10.	" 1000 " " " " " "	+++	++++
11.	" 3000 " " " " " "	++++	++++
12.	" 3000 " " " " " " , green cellophane wrapper	none	±
13.	" 3000 " —Exposed in clear glass, blue cellophane wrapper	±	+
14.	" 3000 " —Exposed in clear glass, yellow cellophane wrapper	++++	++++
15.	" 3000 " —Exposed in clear glass, red cellophane wrapper	+	++
16.	" 3000 " —Exposed in Seal-Cone paper bottle.....	++++	++++

ment. Clarification is effective either before or after homogenizing, but gives better results when used following processing. The clarifier is almost an essential piece of equipment when homogenized milk is being sold.

It has been reported that the Babcock test of homogenized milk gives lower readings, but several studies have shown that the difference is almost negligible and well within the normal limits of error. Better results are obtained by using slightly weaker acid (sp. gr. 1.81—1.815) or by using 1 ml. less than the usual 17.5 ml., and adding the acid slowly with agitation between portions. Such procedure will minimize the tendency toward charring and formation of discs or plugs of charred material under the fat columns.

The color of milk is slightly changed by homogenization, becoming whiter and blanker, sometimes described as chalky. The reason for this is the finer dispersion of the fat. Homogenized milk and homogenized cream both lighten coffee to a greater degree than unhomogenized milk or cream.

One of the greatest objections on the part of health authorities to homogenized milk is the unsanitary construction of the older homogenizers and careless cleaning methods frequently used by plant operators. Until recently the stuffing boxes were practically impossible of access in washing. Equipment of this type has long been outlawed for market milk purposes, and it is not likely that bottled homogenized milk will become an important type of market milk until the equipment used is as accessible for cleaning and is washed and sterilized with equal carefulness to that exercised with the usual milk line equipment. It has been shown that with the more recent sanitary models of homogenizers, bacterial counts no higher than those obtained with ordinary pasteurized milk can be had with homogenized milk. While homogenization tends to break up bacterial clumps and give higher plate counts, clarification following homogenization is more efficient in throwing out bacterial cells, and appears to more than

compensate for the effect of the homogenizer.

It has been assumed, without much factual knowledge having been accumulated, that homogenization improves the digestibility of milk, particularly in the case of infants. This idea is a natural conclusion from the fact, that homogenization drastically lowers the curd tension, and that the curd tension has been advocated as an index of digestibility. The term digestibility is here used to mean the ease and rapidity with which the coagulum formed in the stomach is evacuated through the pylorus and acted upon by the digestive juices of the intestines.

A great deal of work has been conducted at Pennsylvania State College in the last three years in an effort to develop a laboratory method which will measure digestibility and indicate the value of curd tension as an index of digestibility. A method has been devised which seems to give reasonable satisfaction. It is laborious and complicated. For this reason, results have been slow in forthcoming, and insufficient data are available for definite conclusions as yet. However, the following statements will give some idea of the findings. These may have to be modified or altered after the accumulation of more data and after the available data are critically analyzed.

There is reasonably close agreement between curd tension results and digestibility in the case of normal raw or pasteurized untreated milk and in the case of boiled milk.

Homogenized milk does not exhibit as good digestibility characteristics as the curd tension would seem to indicate. The reason for this appears to be that the coagulum, although soft compared with unprocessed milk, is adhesive and holds together in a mass instead of breaking up into a granular or flaky condition. Homogenization undoubtedly improves the digestibility of milk but the curd tension apparently is not an index of the improvement.

LOW PRESSURE HOMOGENIZERS

A number of trials with milk have been made using two low pressure rotary homogenizers, and comparing the results with two high pressure piston machines. The rotary machines were not capable of lowering the curd tension as much as the piston machines, but at equal pressures the rotary machines apparently had a measurably greater effect as shown in Table 4.

Data on reduction of fat globule size are shown in Table 5. It will be noted that at equivalent pressures, the rotary machines caused greater break-up in the fat globules.

The alcohol stability correlated with the data shown in Tables 4 and 5. None of the samples processed by any of the machines exhibited a measurable cream layer after standing 24 hours at 40° F. Upon high speed centrifugation the samples of milk homogenized by the piston machines at high pressure gave no cream layers or fat films. At low homogenizing pressures and with the rotary samples, films were frequently noted. Less separation was noted on the samples of rotary homogenized milk compared with samples of piston homogenized milk processed at similar pressures. This would be expected from the data shown in Table 5. No sedimentation by gravity was observed in any of the samples. Upon cen-

trifugation, sediment was obtained in all of them, the greatest deposits being found in the samples homogenized by the piston machines at high pressure.

The rotary machines were easier to take apart for cleaning than the new sanitary piston machine which was used. Less time was required therefore in cleaning and sterilizing. Both rotary machines were capable of complete dismantling, and all surfaces coming in contact with the milk were readily accessible.

The standing-up qualities of the rotary machines appeared to be good but they were not in use long enough to be rated in this regard.

In conclusion, it would seem that homogenized milk and cream will become a more familiar product in all markets. Within 10 or 15 years, the dairies selling these products will probably be the rule rather than the exception. There are many factors which tend to prevent the appearance of homogenized milk and homogenized cream on our markets at the present time. These, however, will be gradually overcome as the advantages of the products become better appreciated. Regardless of whether homogenized milk is generally accepted by pediatricians as a good base for infant formulas, homogenized milk will probably be accepted and demanded by consumers because of its other obvious merits.

TABLE 4.
Effect of Type of Homogenizer on Curd Tension

Original Curd Tension (grams)	Piston I 650-1000 lbs. (grams)	Piston I 3000 lbs. (grams)	Piston II 650-1000 lbs. (grams)	Piston II 3000 lbs. (grams)	Gear Rotary 800-1000 lbs. (grams)	Bump Rotary 650-850 lbs. (grams)
47	23	18	—	—	22	—
50	29	19	—	—	25	—
52	32	23	—	—	—	26
64	37	—	—	—	35	—
61	44	—	—	—	—	31
48	25	14	—	—	24	—
29	—	—	14	11	12	12
45	—	—	21	15	19	20

TABLE 5.
Effect of Type of Homogenizer on Fat Globule Size (Average several runs)

Original Milk (microns)	Piston I 650-1000 lbs. (microns)	Piston I 3000 lbs. (microns)	Piston II 650-1000 lbs. (microns)	Piston II 3000 lbs. (microns)	Gear Rotary 800-1000 lbs. (microns)	Bump Rotary 650-850 lbs. (microns)
5.11	3.0	1.69	3.26	1.67	2.15	2.59

Report of Committee on Communicable Diseases Affecting Man*

I. A. Merchant, *Chairman*
Iowa State College, Ames, Iowa.

The annual report of this committee has the privilege of extending its scope to almost any phase of milk and dairy sanitation, since epidemics of diseases affecting man may originate any place along the line from the cow to the consumer. Past reports have discussed the various epidemics which have occurred in the United States and Canada, and have drawn attention to some of the factors which have inaugurated and perpetuated them. While our report desires to call attention to the epidemics of milkborne diseases for 1936, it also emphasizes some of the progress which has been made in controlling the diseases of man which are carried by milk and milk products.

The outbreaks of milkborne diseases as reported to the United States Public Service are given in Table 1.

One of the most interesting points brought out in Table 1 is the large number of epidemics of scarlet fever during 1936. Typhoid fever usually holds first place, yet epidemics of this disease were not as numerous as in other years. The great number of cases involved in milkborne scarlet fever is also shown in the table.

The determination of the origin of the organisms which are responsible for epidemics is always imperative. An analysis of the 46 epidemics which appeared in the United States, showing the origin of the various epidemics, appears in Table 2.

The total number of 21 in scarlet fever is due to the presence of more than one case or carrier in some of the epidemics.

The type of milk or milk product which was involved in the epidemics is also of interest. The 46 milkborne epidemics which were recorded in the United States were all caused by raw, sweet milk. In 13 epidemics, the milk was of Grade A quality; in 2 epidemics the milk was Grade B; in 4 epidemics the milk was ungraded; no data were available for the remainder.

In the four typhoid fever epidemics in Canada, one probably originated in a dairy, while the other three originated from Cheddar cheese. Investigation of these three epidemics revealed that they all originated from the same lot of Cheddar cheese which was prepared at a cheese factory at Thorsby, Alberta. The epidemics occurred at Thorsby, Springbank, and Edmonton, all in the Province of Alberta. All occurred simultaneously.

The case of tuberculosis was reported from the province of Manitoba. The case was a tubercular adenitis of a fourteen year old boy. The organism was not recovered from the case and typed, therefore it could not be definitely stated that it was of bovine origin. The herd from which the milk supply originated proved to be one hundred percent tuberculous, and for that reason the case was presumed to be of bovine origin.

The location of the epidemics in the United States is a matter of interest. Table 3 shows the states in which the epidemics occurred. The states reporting the greatest number of epidemics have very efficient milk control programs, and probably for that reason more milkborne epidemics are detected and reported. It is noted in Table 3 that only 21 states reported epidemics of milkborne disease.

*Presented at 26th Annual Meeting of the International Association of Milk Sanitarians, Louisville, Ky., Oct. 11-13, 1937.

What can be done to bring about a more complete reporting of milkborne disease epidemics? Possibly all the cases are reported which are called to the attention of health officers. Yet, we all know that these figures can not represent the true picture in the United States. We know that numerous cases (family epidemics) of septic sore throat and gastroenteritis occur in farm areas. While such cases may be outside the field of organized milk control agencies, they are important and necessary to complete the true epidemiologic picture of milkborne diseases.

The methods by which faulty pasteurization of milk may be detected have received much study during recent years.

One of the newer methods, the phosphatase test, shows great possibilities.

THE PHOSPHATASE TEST AS AN EPIDEMIOLOGICAL AID*

The New York State Department of Health, in its weekly Health News of August 2, 1937, reported its first practical application of the phosphatase test (for determination of faulty pasteurization) in connection with the investigation of a disease outbreak. Early in July, an outbreak of about 75 cases of gastroenteritis occurred in two associated children's camps. The onsets occurred a few hours

*Prepared by Paul B. Brooks, M. D.

TABLE 1

Milkborne Epidemics* 1936

Diseases	Number of epidemics	Cases in community	Cases using suspected supply	Deaths
UNITED STATES:				
Typhoid fever	15	114	103	5
Paratyphoid fever	1	21	21	0
Scarlet fever	16	1222	971	16
Septic sore throat	6	271	268	7
Gastroenteritis	2	63	63	0
Enteritis	1	25	25	0
Food poisoning	1	100	100	0
Undulant fever	4	15	14	0
Totals	46	1831	1565	28
CANADA:				
Typhoid fever	4	—	28	4
Undulant fever	—	—	12	0
Tuberculosis	—	—	1	0
Totals	4	—	41	4

*In this report the term epidemic is applied to cases of disease involving one or more persons.

TABLE 2

Origin of Milkborne Epidemics in United States

	Typhoid fever	Paratyphoid fever	Scarlet fever	Septic sore throat	Gastroenteritis and food poisoning	Undulant fever	Total
Cases	3	—	15	5	—	—	23
Carrier	7	1	5	1	—	—	13
Cow	—	—	1	—	3	4	8
Water	1	—	—	—	—	—	1
Undetermined	4	—	—	1	1	—	6

TABLE 3

Distribution of Milkborne Epidemics by States—1936

State	Typhoid fever	Paratyphoid fever	Scarlet fever	Septic sore throat	Gastro-enteritis, etc.	Undulant fever	Total Epidemics	Total cases
New York	1 (11)*		6 (686)	2 (58)	1 (36)		10	791
California	5 (24)					1 (3)	6	27
Wisconsin			6 (150)				6	150
Massachusetts	1 (1)					2 (10)	3	11
Illinois			2 (94)				2	94
Kentucky		1 (21)		1 (5)			2	26
New Mexico			1 (4)	1 (6)			2	10
Washington	1 (10)					1 (1)	2	11
Connecticut				1 (24)			1	24
Florida	1 (2)						1	2
Georgia	1 (23)						1	23
Michigan					1 (25)		1	25
Minnesota	1 (8)						1	8
Montana	1 (11)						1	11
Nebraska	1 (2)						1	2
New Jersey				1 (175)			1	175
Ohio					1 (100)		1	100
Pennsylvania			1 (37)				1	37
Rhode Island					1 (27)		1	27
Texas	1 (9)						1	9
Virginia	1 (2)						1	2

*Figures in parenthesis represent number of cases.

after consumption of milk purchased from a local producer-dealer as Grade A Pasteurized. The milk was delivered to the camp in cans. Epidemiological evidence pointed clearly to this milk as the cause of the outbreak.

A department veterinarian, on examination of the herd supplying the milk, found several cows with bad udders. Among them was one showing extensive udder involvement and giving obviously abnormal milk. This cow was slaughtered and the udder taken to the state laboratory. On sectioning, discharging abscesses were revealed. Hemolytic streptococci, not of the type commonly associated with scarlet fever and septic sore throat, were found on culturing. At the time of the state veterinarian's visit to the dairy, the dealer produced a report apparently indicating that the herd, including the

above-mentioned cow, had been examined a few days previously by a local veterinarian.

The investigators were able to secure a sample of milk from the same can from which that responsible for the outbreak was said to have been taken. The phosphatase test proved it to be raw milk. Hemolytic streptococci, as well as bacilli of the colon group, were isolated from this sample.

On investigation at the plant, it appeared that the substitution of raw milk probably was accidental, due to careless methods of handling. The dealer ordinarily used separate cooling vats for cans of raw and pasteurized milk. Due to a leak in one of the vats, all of the cans had been stored in one vat, the raw milk supposedly in one end, the pasteurized in the other. The cans were not adequately

labeled, and the supposition was that an employee had taken out a can of unpasteurized milk by mistake.

A year or more before this incident, a milkborne epidemic of scarlet fever and "sore throat" occurred in two CCC camps under similar circumstances. The milk was purchased for the camps as having been pasteurized, but there was considerable evidence suggesting that the milk responsible for the epidemic never had been in the pasteurizer. Experts who examined the temperature charts at the plant believed that some of them had been "manufactured" for the occasion. The case was turned over to the legal authorities for prosecution but ultimately was dropped, on the ground that the evidence was not such as to convince a lay jury. The result of the phosphatase test, in the more recent outbreak, supplied the hitherto missing link in the chain of evidence.

MILKBORNE STREPTOCOCCUS INFECTION*

This was the subject of a symposium presented in connection with the 1927 Annual Conference of Health Officers and Public Health Nurses in New York State. The discussion brought out the facts that studies of milkborne epidemics of so-called scarlet fever and septic sore throat, made in New York state and elsewhere, have thrown considerable light on the subject of streptococcus infection in general, and furnished evidence strongly suggesting that scarlet fever, septic sore throat, and erysipelas, instead of being separate and distinct clinical entities, incited by specific strains or types of hemolytic streptococci, simply represent different individual reactions to the same infecting agent.

New York State, Dr. Ramsey pointed out, "according to the published records" had had a larger experience with milkborne epidemics of scarlet fever and septic sore throat than any other state. Some of the discrepancy, he believed, was due to differences in reporting. In the preceding two years, he said, nearly all such epidemics occurring in the state had been

carefully studied. Epidemiologically, according to Dr. Ramsey, there is no distinction between the two conditions, "the characteristics being the same, regardless of the name given the disease". Milk should always be suspected, he said, when a number of cases occur with onsets almost simultaneous.

Dr. Stebbins, in collaboration with Dr. Hollis S. Ingraham, had made detailed studies of several of the more recent epidemics. The studies cited related to three epidemics "classified as scarlet fever", aggregating 801 cases, and three of septic sore throat, totaling 590 cases. From a comparative study of symptomatology in groups of over a hundred cases each in the two types of epidemics, he concluded that, except for rash and desquamation, the "signs and symptoms" were practically the same for the two types of illness. Of 749 cases associated with scarlet fever epidemics, 14 percent gave a history of having had scarlet fever previously. Of these, only 30 percent developed typical rash, whereas among those giving no history of previous scarlet fever, 64 percent developed typical rash. From this and previously published data, it appears that persons who have had scarlet fever are not protected against reinfection, but are much less likely to develop rash when reinfected. Dr. Stebbins showed that cases of erysipelas occurred in connection with each of two epidemics of scarlet fever and two of septic sore throat studied with reference to complications. Usually the erysipelas occurred in persons previously having throat infections, but, in a few cases, apparently occurred as a primary infection.

Miss Coffey's discussion related chiefly to the functions of the laboratory in connection with the investigation of epidemics. She pointed out, however, that "the streptococci associated with scarlet fever, septic sore throat, and other infections cannot be differentiated by laboratory procedures". "Streptococci with the characters attributed to *Streptococcus epidemicus*, the reported incitant of septic sore throat", she said, "are encountered in scar-

*Prepared by Paul B. Brooks, M. D.

let fever, erysipelas, puerperal sepsis, and other streptococcus infections. Moreover, not all strains associated with septic sore throat have the properties of the so-called *Streptococcus epidemicus*. Similarly, studies of the toxigenic properties of strains from different sources have failed to demonstrate a specific relationship between a particular toxin and the disease manifestation."

Dr. Brooks, in general discussion, brought out the following facts relating to epidemics:

Epidemics of septic sore throat usually are milkborne.

In most extensive milkborne epidemics, either of septic sore throat or scarlet fever, cows with mastitis are involved.

The cow, probably invariably, has been infected with an organism from a human source, i. e., a person with a throat or other infection.

Dr. Brooks referred to Dr. Anna Williams' book on Streptococci, published in 1932, in which she cited several epidemics in which it was reported that septic sore throat and scarlet fever cases occurred. In one of these, in England in 1892, the report stated "Definitely both conditions. Those who had had scarlet fever had only sore throat." Dr. Williams quoted Dr. W. G. Smillie as saying, in 1917, that in many so-called septic sore throat outbreaks, scarlet fever cases also were observed. Erysipelas cases, Dr. Brooks pointed out, had occurred in practically all of the New York state epidemics recently studied. Thus, he said it appeared that, in an individual epidemic, a single strain of hemolytic streptococci from one human carrier and coming through the medium of a cow's udder, was responsible for all three conditions. This suggests, he said that all were merely different individual reactions to the same infecting agent, and "scarlet fever is simply septic sore throat plus rash." As another evidence of nonspecificity of strains, he referred to the results of an experiment cited by Dr. Williams. Two large groups of children were used, all of whom were

known to react positively to skin tests with both "scarlet fever" toxin and "erysipelas" toxin. One group was inoculated with "erysipelas" toxin and later skin-tested with "scarlet fever" toxin; the other group inoculated with "scarlet fever" toxin and later tested with "erysipelas" toxin. The results of nearly all of the tests, in both groups, were negative, showing that "erysipelas" toxin produced immunity to "scarlet fever" toxin and vice versa.

GASTROENTERITIS AND FOOD POISONING

Since the 1935 report of this Committee, which discussed in a brief way the subject of food poisoning, numerous reports of epidemics of gastroenteritis have been made. Many of these epidemics have been traced to milk and to an infected dairy cow.

In considering food poisoning as being an acute gastroenteritis, a number of different etiologic agents must be kept in mind. *First*: the staphylococcus toxin, or rather that particular part of the toxin complex of the organism known as gastroenteric toxin which causes an acute condition apparent within two to four hours, manifested by nausea, abdominal pain, and diarrhea. *Second*: infection due to Salmonella organisms, more particularly *Salmonella enteritidis* and other members of the colon-typhoid group which is a condition appearing not less than six and frequently as high as seventy-two hours after consuming the infected food; symptoms similar to the above. *Third*: an alkaloid poisoning due to drinking milk from cows which have eaten white snake root or rayless goldenrod. Although rare, these weeds are found in certain sections of the United States. The alkaloid, trematol, which is found in both plants causes a condition known as trembles in cattle and other animals, and in man produces symptoms similar to those caused by staphylococcus toxin. *Fourth*: the streptococci apparently, may produce toxic products which can cause acute intestinal disturbances. The report just given of the cases in New York is evidence of that fact. Just what species of strepto-

coccus was incriminated and what the toxic substance may have been was not determined.

The great majority of the acute cases of food poisoning are due to the staphylococci. Those which arise from milk are for the most part due to a staphylococcal mastitis in one or more cows in the herd. Shaughnessy and Grubb have recently made some valuable suggestions for the investigation of such outbreaks. They stated:

"In each outbreak of staphylococcus food poisoning that we have investigated, cows with staphylococcus mastitis have been detected in the herd supplying the milk. This suggests that parasitic staphylococci may be more capable of producing enterotoxin than saprophytic staphylococci.

In investigating outbreaks of staphylococcus milk-poisoning, some persons who appear to be naturally unsusceptible and others who seem to have become immunized to the staphylococcus enterotoxin have been encountered. These findings may mislead the investigator in tracing the offending food. In localities where milk sickness, caused by white snake-root, occurs, the investigator must be careful to distinguish this type of poisoning from staphylococcus milk poisoning.

The most reliable method at the present time for detecting food-poisoning strains of staphylococci is to culture suspected strains under conditions favorable for the production of the enterotoxin, and feed the sterile filtrate of the cultures to human volunteers—*with due precautions*. When such a procedure is not practicable and the presence of large numbers of staphylococci in the milk from cows which chemical and microscopic tests indicate have a mastitis infection and clinical findings point to a staphylococcus poisoning, it is considered that these findings constitute presumptive evidence for the diagnosis of staphylococcus milk-poisoning and warrant the elimination of the infected animals from the herd."

STAPHYLOCOCCIC MASTITIS OF COWS

Numerous surveys which have been made of the bacterial flora of the infected bovine udder have concluded that streptococci played the most dominant role. Most of these conclusions have

undoubtedly been formed after the investigation of herds with acute mastitis which involved a large number of animals. One wonders if the situation is the same, however, when large number of herds have been examined and when the organisms present in one or two infected cows are identified. Many of the cases of staphylococcus milk-poisoning have been traced to only one cow in the herd. It would seem evident, therefore, from the public health point of view, that individual cases of bovine mastitis present a problem of importance and that staphylococcal mastitis must be revalued in the light of present-day knowledge.

Gwatkin and his associates in Canada have contributed valuable information concerning staphylococcal mastitis. In a recently published report, they made the following summary:

"Nineteen cases (7.3 per cent) of mastitis in which staphylococci appeared to be the etiological factor were detected during the examination of 260 cows.

One hundred and ninety of 275 strains of *Staphylococcus pyogenes* fermented mannitol and 85 were negative. Twenty-four positive (12.5 percent) and 60 percent of the negative strains were recovered from apparently normal udders.

Forty of 65 strains of staphylococci showed some degree of zone production on Stone's beef extract-gelatin-agar plates and 11 of these liquefied Stone's beef extract-gelatin. Seventeen kittens were given intraperitoneal injections of 3 cc. of boiled filtrates of some of these strains and seven of them showed some gastrointestinal symptoms, in one case severe. Two, however, had worms in their vomitus and should probably be excluded. All the kittens injected with filtrates showed lassitude. Two of the kittens that vomited had received filtrates of strains that were negative by both gelatin tests. (These were not the two that had worms in the vomitus.) One of the four kittens injected with unseeded, boiled medium manifested some pain and uneasiness for about five minutes but no lassitude. The other three showed no symptoms.

Agglutination and complement-fixation tests on blood serum and whey from streptococcal and staphylococcal cases were negative.

Sixty-two samples of blood serum were examined for their content of staphylococcus antitoxin in terms of International Standard Units. In a group of 42 abattoir samples from heifers and young steers, only about 12 percent had four or more units per cc. In a group of 14 staphylococcal mastitis cases, 79 percent had 4 units and over, and 64 percent had 10 units and over as compared with 2.4 percent of the abattoir group. Two cases of *Streptococcus mastitidis* infection had 2.5 units per cc. each.

One cow was found from which staphylococci were isolated but which did not have mastitis at the time of examination. The blood serum had a titre of 38 units per cc. This cow was from a herd in which there were three definite cases of staphylococcal mastitis. In the examination of 32 samples of whey for the presence of antitoxin, the milk of one cow showed the same titre of antitoxin as was present in the serum, namely 20 units per cc, from one quarter of the udder. The content of antitoxin in the milk of the other three quarters was low. In a second cow with a serum titre of 20 units, the whey had five units per cc in one quarter and from 1.5 to 2.5 in the others. Samples from other cows suffering from mastitis were in the last named range."

It is evident, from this summary, that the complete study of staphylococci found in bovine mastitis should be subjected to careful laboratory studies involving carbohydrate fermentation, toxin formation, and toxin antitoxin neutralization.

In a survey of the incidence of mastitis in the cows supplying milk to the city of Ames, Iowa, Venzke has obtained some interesting results. The survey is not complete so this material has not been published. In detecting mastitis, the strip cup, the chloride test and palpation were used. Samples of milk from chloride positive quarters were taken to the laboratory, incubated 12 hours and 0.2 cc. plated in 5 percent horse-serum beef-infusion agar. The predominating types of organisms were isolated and classified by the fermentation of sucrose, lactose, mannite and raffinose, by pigmentation, and by the zone produced in Stone's gelatin-agar. The cows were for the most part ordinary farm animals in which no concerted effort had been made to eliminate mastitis.

Results which have been obtained thus far in this study are presented in Table 4.

While there are many things of interest in this table, the most significant for our purpose are the 107 cows with parasitic staphylococci in their udders, and the rather small number, 15 cows, with streptococcal mastitis. It is of interest, also, to note that of the 231 cultures of staphylococci, 135 fermented mannite and 26 showed positive reactions on Stone's gelatin-agar.

It would seem that in this number of cows, there were numerous potential sources of milk-poisoning epidemics. The dilution and pasteurization of the milk

TABLE 4

Mastitis Incidence in Farm Dairy Herds

40 individual herds tested
574 cows, 2296 quarters tested
38 cows (6.6 percent), 51 quarters (2.2 percent) positive by strip cup
235 cows (41.1 percent), 535 quarters (23.3 percent) positive by chloride test
366 cows (63.7 percent), 996 quarters (43.3 percent) positive by palpation
45 cows with 67 quarters yielded <i>Staphylococcus aureus</i>
62 cows with 92 quarters yielded <i>Staphylococcus albus</i>
46 cows with 65 quarters yielded <i>Staphylococcus epidermidis</i>
6 cows with 7 quarters yielded <i>Staphylococcus citreus</i>
25 cows with 31 quarters yielded <i>Micrococci sp</i>
3 cows with 6 quarters yielded <i>Streptococcus lactis</i>
15 cows with 28 quarters yielded <i>Streptococcus agalactiae</i> .

from these animals were probably the controlling factors. It would be of value to know if any of the families on the farms harboring infected animals suffer periodically with intestinal disturbances. This we hope to determine in the continuation of our work. However, one must keep in mind the immunity which may have been produced throughout the years when such milk has been consumed.

TUBERCULOSIS

Tuberculosis is not extinct in the United States or in Canada. The case of tuberculous adenitis reported from Canada is good evidence that scattered cases must appear from time to time. Tuberculosis of bovine origin, in the past, has been generally believed to be of the non-pulmonary type. Our attention, however, is called to the fact that pulmonary tuberculosis may also be caused by the bovine organism by the following editorial in the *American Journal of Public Health*:

"From time to time we have published editorials on the transmission of bovine tuberculosis to human beings. That such infection takes place was definitely proved at the University of Pennsylvania in 1902. The reports of the British Royal Commission and of the German Imperial Commission amply confirmed the findings, and since that time no one has seriously questioned the danger to human beings, especially children, of tuberculosis in cattle. The vehicle of transmission is, in the vast majority of cases, milk. We have more or less complacently accepted the fact that the bovine type of organism is transmissible to human beings, and that it is prone to produce lesions of the glands and bones; but not the pulmonary disease known generally as consumption. There have been many articles arguing for the relative unimportance of bovine infection, and the National Tuberculosis Association decided not to engage in that phase of the tuberculosis problem.

"Our complacency in this regard has been considerably ruffled by the reports of pulmonary tuberculosis due to the bovine organism. From February, 1931, to July, 1933, the State Serum Institute of Copenhagen found the bovine type of organism in 26 patients

suffering from pulmonary tuberculosis. During approximately the same period, the bovine type was found in 39 specimens of pus from the cervical glands, in the cerebral spinal fluid, and urine taken from the residents of Copenhagen. All of these patients were under thirty-two years of age and 10 under five years. In only one case was open tuberculosis found in another occupant of the patient's home. The writers of the report state that, so far from pulmonary tuberculosis due to the bovine type being rare, it is, as a matter of fact, extremely common.

"In Amsterdam, in an examination of 115 adults suffering from pulmonary tuberculosis, three gave the bovine organism, and in the province of North Holland, 10 out of 89 such cases also gave the bovine organism. Gastric lavage of 110 children yielded the bovine organism in nine. Examination of material from other forms of tuberculosis gave 55 human type and eleven bovine, but this latter finding is not pertinent to the present discussion. Griffith and Smith, on the basis of extensive investigation in the northeast and southern counties of Scotland, make the statement that pulmonary tuberculosis is frequently caused by the bovine type of organism. From April, 1934, to December, 1935, these authors investigated 103 cases of pulmonary tuberculosis, in 13 of which the bovine type of organism was cultivated from the sputum. In five of these, there was a history of previous glandular tuberculosis so that the channel of entry was almost certainly the alimentary canal.

"America appears to have fallen behind in this investigation. As far as we are aware, there is no laboratory in the United States doing systematic typing of cases of pulmonary tuberculosis. It is a tedious and expensive piece of work which can be undertaken only by well financed organizations, but that should be no bar to the investigation. It is not too much to say that we have no idea at the present time how many cases of pulmonary tuberculosis are occurring from infection with the bovine type of bacillus. We believe that we are in a better position as regards bovine tuberculosis than other countries, due to the activities of our Bureau of Animal Industry, but this does not excuse our lack of interest and activity in regard to the particular question under discussion.

"Very recently the editor has been repeatedly urged to take the matter up and do all within his power to bring about such studies as are being made in England and some of the Scandinavian countries. This is due to a situation in some of our states so serious as to excite apprehension.

"As an actual fact, we do not know what is going on, and this of itself is sufficient reason for undertaking the study."

Statements have been made from time to time that the decrease in the number of tuberculin reactors in dairy cattle in the United States is a factor which accounts for the decreased rate in nonpulmonary tuberculosis in humans. While this may be true, no one has subjected the figures to a careful statistical analysis. If such a fine index as the cases of tuberculous adenitis in children under 16 years of age would be correlated to the decrease in the percentage of bovine tuberculin reactors, we may have a significant result. It may be of value to record here the results of tuberculin testing in the cattle herds of the United States since the tuberculosis eradication program was initiated in 1917. This is shown in Table 5.

BRUCELLOSIS (UNDULANT FEVER)

Brucellosis (undulant fever) continues to hold a prominent place in the minds of the milk producers and consumers on the American continent. It is an undisputed fact that numerous cases of this disease result from drinking milk from infected cows, but contact with the infection which may be present in other farm animals, hogs and horses, probably affords just as great an avenue of infection especially in midwestern states. It will be seen in Table 6 that 2044 cases of Brucellosis were reported in the United States during 1936. In Table 1 there are only 14 cases reported as having originated definitely from milk. This emphasizes the fact that numerous cases of disease are not traced to their origin, thereby leaving the impression that many are caused by drinking infected, raw milk.

Bang's disease eradication is continuing to make progress in the United States. More progress has been made in some

TABLE 5

Progress of Tuberculin Testing, United States, 1917-36

Year ended June 30—	Number tested	Number reacted	Percent reacted
1917.....	20,101	645	3.2
1918.....	134,143	6,544	4.9
1919.....	329,878	13,528	4.1
1920.....	700,670	28,709	4.1
1921.....	1,366,358	53,768	3.9
1922.....	2,384,236	82,569	3.5
1923.....	3,460,849	113,844	3.3
1924.....	5,312,364	171,559	3.2
1925.....	7,000,028	214,491	3.1
1926.....	8,650,780	323,084	3.7
1927.....	9,700,176	285,361	2.9
1928.....	11,281,490	262,113	2.3
1929.....	11,683,720	206,764	1.8
1930.....	12,845,871	216,932	1.7
1931.....	13,782,273	203,778	1.5
1932.....	13,443,557	254,785	1.9
1933.....	13,073,894	255,096	2.0
1934.....	15,119,763	232,368	1.5
1935.....	25,237,532	376,623	1.5
1936.....	22,918,038	165,496	.7
Total.....	178,445,721	3,468,057	1.9

states than in others. The Chief of the United States Bureau of Animal Industry reported: "During the fiscal year 1936, agglutination blood tests for Bang's disease were applied to approximately 6,600,000 cattle. A considerable num-

TABLE 6

Brucellosis Cases in the United States, 1936

Alabama	43	Nebraska	1
Arizona	35	New Hampshire	50
Arkansas	35	New Jersey	58
California	172	New Mexico	21
Colorado	1	New York	214
Connecticut	99	North Carolina	23
Delaware	2	North Dakota	1
Florida	16	Ohio	79
Georgia	20	Oklahoma	96
Illinois	84	Oregon	21
Indiana	55	Pennsylvania	101
Iowa	113	Rhode Island	12
Kansas	96	South Carolina	9
Kentucky	51	South Dakota	4
Louisiana	37	Tennessee	26
Maine	13	Texas	36
Maryland	41	Utah	10
Massachusetts	55	Vermont	18
Michigan	27	Virginia	33
Minnesota	76	Washington	33
Mississippi	9	W. Virginia	1
Missouri	9	Wisconsin	107
Montana	4		
		TOTAL	2,044

ber of the tests were retests. Of this number of cattle tested, approximately 445,000 or 7 percent, were declared to be reactors to the test."

In view of the fact that indemnity is paid to cattle owners for reacting cattle, all communities should avail themselves of this opportunity to establish Bang's disease free herds for their milk supply, thereby eliminating that source of Brucellosis.

POLIOMYELITIS

The large number of poliomyelitis cases during the past summer has made those interested in milk-control rather uneasy. Very little definite knowledge is available concerning the spread of this disease, but Rosenau cites a few instances where milk supplies have been incriminated.* All cases of poliomyelitis should be thoroughly investigated to determine their contact with milk supplies.

I. A. MERCHANT, *Chairman*
 PAUL B. BROOKS
 L. C. BULMER
 LESLIE C. FRANK
 F. L. MICKLE
 HORATIO N. PARKER
 A. R. B. RICHMOND
 W. W. SCOFIELD

REFERENCES

- United Public Health Service. Outbreaks of Disease Caused by Milk and Milk Products as Reported by Health Authorities as Having Occurred in the United States in 1936.
- Gwatkin, Ronald. Further Observations on Staphylococcal Infections of the Bovine Udder. *Canadian Public Health Journal*, 28, 185, April (1937).
- Shaughnessy, H. J. and Grubb, T. C. The Incrimination of Milk and Milk Products in Staphylococcus Poisoning. *Canadian Public Health Journal* 28, 229, May (1937).
- Rosenau, M. J. Preventive Medicine and Hygiene. D. Appleton-Century Company, New York, 1935.
- Editorial. Pulmonary Tuberculosis Due to Bovine Tubercle Bacilli. *American Journal Public Health*, 26, 1128, November (1936).
- Mohler, J. R. Report of the Chief of the Bureau of Animal Industry. U. S. D. A., Washington, D. C., 1936.

*Editor: See also Rosenow. *J. Infect. Dis.* 50, 377 (1932); *J. Pediat.* 2, 568 (1933).

Methods of Analysis for the Butter Industry.—*Laboratory Manual prepared by the Research Committee, American Butter Institute, 1937. 48 pp. Price \$1.00.*

The Institute's laboratory manual fills every need of the butter industry, food and dairy inspectors, laboratory workers, health officials, and consumers for a compendium of accurate, reasonably simple, and relatively inexpensive procedures. The methods outlined are those used in the laboratory of the American Butter Institute.

The ten sections of the manual cover sampling, microbiological examination, chemical analysis, and the determination of flavor factors in butter. The testing of

milk, skim milk and cream for acidity, sediment, and fat content are also covered, with chapters on keeping quality determination and the checking of acidity and salt test solutions.

The user's comfort has been considered in other directions, also, in the preparation of the manual. It is well printed, in a readable type face on restful India tinted paper. Another important feature is the binding which permits the book to lie flat on the desk when in use and facilitates insertion of replacement sheets as issued.

Interested health officials desirous of obtaining the manual should communicate with the American Butter Institute, 110 North Franklin Street, Chicago.

Note on the Starch-Iodide Test for the Detection of Free Chlorine in Milk

T. H. Butterworth, Ph. D.

Formerly Milk Analyst, San Antonio Department of Health.

Occasionally one finds it expedient to test milk for the presence of residual or free chlorine. This test is indicated when patrons having an established reputation for high count milk suddenly begin delivering milk of one or two thousand organisms per cubic centimeter, or when low bacteria counts are associated with filthy sediment tests or similar signs that the bacterial content of a milk has been reduced by other means than care, cleanliness, and cooling.

The customary test is the starch-iodide reaction in which the iodine in potassium-iodide is replaced in an acid medium by any free chlorine which is present, the liberated iodine then being detected by a starch indicator solution. The usual procedure is to add the chemicals directly to the milk, noting the blue coloration formed from the starch-iodine combination in the serum below the curd after heating. In practice, however, the curd frequently forms a plug in the tube, holding back the indicator solution when added; if the tube is then shaken, the particles of curd cause a decided masking

effect on the color in faint reactions. Such tests are frequently called negative or doubtful, and in either case are unsatisfactory.

The following extremely simple modification of the test has been found to obviate this difficulty and is recommended for all samples suspected of containing but small amounts of free chlorine.

To 50 cc. of the milk in question there is added 3 cc. of a 25 percent acetic acid solution. The milk is then warmed in a water bath just sufficiently to cause the curd to mass up and give a clear whey. Five cc. of the whey is then pipetted to a test tube, and the test is carried out as usual by adding $1\frac{1}{2}$ cc. of a 9 percent potassium-iodide solution, except that only 2 cc. of a 50 percent hydrochloric acid solution is added instead of the customary 4 cc. The tube is heated at 180° F. for ten minutes, and cooled. Then 2 cc. of a 2 percent starch solution is added. In the case of faintly positive reactions, the blue of the starch-iodine reaction shows more distinctly in the clear milk serum than when the curd is present.

Description of Milk Sanitation Ratings

In order to inform communities concerning the relative quality and safety of their milk supplies, the U. S. Public Health Service has been using a system of rating whereby a numerical score indicates the degree of compliance with local regulatory measures. This score is calculated on the ratings of the producing farms, the processing plants, and the product itself, and is finally weighted on the basis of the respective amounts of

milk handled. Details concerning the methods of calculating the score, together with illustrations of the procedure, are described in an article on "Sanitation Ratings of Milk Sheds," by Frank, Fuchs, and Dashiell, published in *Public Health Reports*, Vol. 53, No. 32, pages 1386-1399, August 12, 1938. Copies can be obtained by writing to the National Institute of Health, Washington, D. C.

A New Bacteriological Control Unit

By Maurice H. Shorago

Boston, Massachusetts

The education of the consuming public to the thought that all manufactured products in general and food products in particular must be handled under strict laboratory control has presented the dairy manufacturing industry with the problem of the necessity of having adequate inexpensive control apparatus. One of the prime factors in the relatively slow response to this demand has been the plaint "our plant has no spare room that can be devoted to the housing of a laboratory."

During the past ten years a great many of the smaller New England milk companies felt the urge to install laboratory equipment, and have called on the author for advice. Through the experience thus gained, a compact, efficient bacteriological control unit was devised that satisfies

these needs of the industry. This unit is illustrated in Figure 1. The apparatus is made up of a large, dry air, sterilizing oven; a self-contained, electrically heated autoclave; an electrical incubator of large capacity equipped with constant, forced circulation of air; two electrical hot plates; and a self-contained transformer. All of this equipment is housed in a stainless steel cabinet, with the top portion utilized as a work bench. The equipment is thoroughly insulated throughout. The only installation required is simply inserting the plug into a suitable receptacle.

The unit is designed to handle plates and cultures, and is admirably adapted to the use of the resazurin test for country plants. This equipment is not to be confused with the ordinary lightly constructed room-consuming laboratory equipment but offers for the first time a complete bacteriological laboratory that can be placed in a space of approximately 6 x 4 feet.

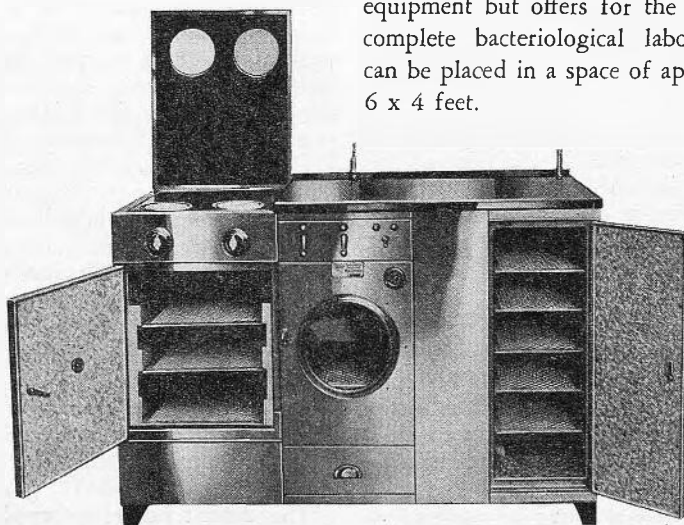

FIGURE 1. *Laboratory Unit*

Report of Committee on Milk Plant Practice

A. R. Tolland, *Chairman*

Health Department, Boston, Mass.

In 1856 the Legislature of Massachusetts, in response to an appeal by physicians, health officers, and citizens interested in the furthering of public health enacted a law providing for the control of the milk supply of the City of Boston.

When pasteurization was first practiced there it was done not so much as a health safeguard as to make possible the sale of partly decomposed milk which otherwise would not be salable. After a series of milkborne epidemics, costly in their toll of lives, health authorities as well as dealers began to realize that raw milk was not a safe supply, due not only to the conditions under which it was produced but also to the human element in its handling.

Pasteurization by the holding method was first set up in Boston in 1907. In this year there were 760 deaths of children less than two years old due to diarrhea and gastroenteritis. Contrast this with our 1935 report of 49 such deaths with our milk supply 99.8 percent pasteurized.

It has been axiomatic that following any milkborne epidemic, the faith of the consumer is inevitably shaken, with a resultant decline in consumption and loss to both dealer and farmer.

It therefore follows that pasteurization is the most readily adopted safeguard for any milk supply. Every care should be taken to have the milk produced from clean healthy stock, under sanitary conditions, and processed by modern methods available to all, and delivered in a package which is capped in such a man-

ner that the pouring lip is protected from contamination by anyone handling it.

SOAKER WASHERS, OR WASHING MILK BOTTLES

Considerable work has been done on this subject by Professor Levine of Ames, Iowa, for the American Bottlers of Carbonated Beverages.¹ Also, some of the largest manufacturers of soaker washers in this country are doing extensive research work on bottle washers.

By using higher temperatures, there is a lowering in the percentage of causticity as well as the time of exposure to the caustic. These investigators have proved that different plants need different temperatures and time, as well as lower caustic strength. One hundred seventy degrees F. for 3 minutes in a 2½ percent caustic will give a sterile bottle. It should be necessary to provide recording thermometers on the various tanks, located at the front end of the washer, so that the operator can watch his temperatures. Some small washers are using 180° F. for five minutes in a 2½ percent caustic; larger, 60 per minute, are using 180° F. in a 2½ percent caustic from 3½ to close to 5 minutes. It appears that some of these authorities are not too keen on brush washers, claiming that if you get ropy milk from the country into the plant, as sometimes happens, the organism may get onto the brush of the washer and be carried from one bottle to another. Some attention has been paid to covers over conveyors.

Heat penetrates much quicker than caustic; hence the reason for increasing temperatures.

The dirtiest bottles returned to plants come from bottle exchanges, and it would

¹Presented at 26th Annual Meeting of the International Association of Milk Sanitarians, Louisville, Ky., Oct. 11-13, 1937.

appear that bottle exchanges should employ a soaker washer and send these bottles back clean.

These same authorities also state, "Do not use re-circulated water." In some sections of Philadelphia, all water going into washers must be chlorinated.

PAPER BOTTLES

The use of paper bottles has not been too successful in this territory because of competitive conditions. The housewife is milk-conscious, and looks for the cream line. There are many angles to this problem for the milk dealer. He must operate a milk bottle factory, as these bottles will come to his plant in pressed form, and it is his problem to put them in shape for a final package.

I have been informed by some dealers that factories manufacturing single service containers cannot fill their orders.

As milk control officials, we should insist that all paper bottles be sterilized immediately before using. Preparing these bottles in a central plant for delivery to distant plants would be extremely difficult. It may be possible to make bottles in a central plant and sterilize them in a plant where they are to be filled.

(Editor: See discussion on this subject in the July issue of this Journal.)

PROPER PROCEDURE FOR MAINTAINING THE NORMAL VISCOSITY OF CREAM

We find there is a very good set-up for cream now operating in Connecticut. They use a small stainless steel spray vat, pasteurize their cream at 145° F. for thirty minutes, and cool with ice water right in the vat down to 40° F. The water would be about 38° F. They use an airtight separator which gives, as they claim, the best body. Of course the first essential is good milk. Separate the milk at 85° F. and run into the vat. Keep the water temperature at about 100° F. Keep this temperature differential of 15° all the way up to 160° F., and then cool slowly. The same applies to heat. Heat slowly. It is claimed there is no cream plug, no feathering, no oiling, and a very good body for the cream. If you cool

over a tubular cooler instead of the vat, cool slowly to about 55° F., and gradually drop to 50°.

The reasons given by Sommers (Theory and Practice of Ice Cream Making, Olsen Publishing Co., 1934) for the causes of cream plug and which incidentally cause oiling off, are:

1. Agitation of the milk at the farm and in transit.
2. Severe agitation and heating during processing.
3. Agitation of cream in separating.
4. Freezing of milk and cream.

The extensive use of cream for household purposes is a development of recent years. This was made possible by the development of suitable means for securing the cream in a fresh condition, and maintaining this condition by cooling until consumed. In this day of milk market instability, it is extremely necessary that we pay particular attention to the quality of our cream.²

First of all, let us consider the various factors on which cream is scored. The housewife is interested in the flavor, viscosity, color, whipping ability, appearance in coffee, serum separation, and freedom from a plug. The restaurant and hotel proprietor is interested in its coffee-coloring ability and keeping quality. The dairy chemist is interested in all of the above factors, plus its condition as revealed by bacteriological examination, microscopic appearance, and acidity determination. All of these factors influence and direct the methods with which we handle bottled cream.

From the outset, the quality of cream is naturally dependent on the quality of the milk from which it is derived. All factors contributory to poorly flavored or poor quality milk will affect the cream separated therefrom, with the possible exception of lipase milk. The enzyme causing this off flavor in milk can be arrested by heating to 110° F. momentarily.

SEPARATION. The temperature at which cream is separated is dependent on the use to which it is to be put and the treatment it will be accorded subsequently. It

has been the experience of others, as well as ourselves, that separation at pasteurizing temperature gives the cleanest differentiation. Separation at this temperature does, however, reduce the tenacity with which the fat globule is held and oiling off ensues. If the cream is homogenized in a later step, prior to bottling, then this factor is of little importance.

PASTEURIZATION. In the pasteurization process too much heat and agitation will likewise contribute to oiling off. It is therefore desirable that a slow paddle be used for agitation, that the vat will not be filled too quickly, and that the heating time will be restricted to no longer than 30 minutes.

COOLING. If the cream is cooled in the same vat in which it is heated, then it is desirable that the cooling be done as quickly as possible and with the least possible amount of agitation. If the cream is run over a cooler, care should be exercised that freezing on the cooler does not take place, for this fault causes the cream to oil off six times worse than similar cream agitated for 30 minutes at pasteurization temperature.

In conducting these procedures of separation, pasteurization, and cooling, the greater the length of sanitary line and the larger the number of pumps necessary for fulfilling these functions, the greater is the possibility of causing fat globule separation.

Laboratory tests for oiling off of cream may be conducted by using coffee, hot water, or the more quantitative method of using hot water, a definite amount of cream, and centrifugal force. With the latter method, a skim milk test bottle is used and the amount of fat separation expressed in percent. Because of the difference between water and coffee, and for direct correlation with results obtained by the housewife, it is more desirable to use coffee as a testing media wherever facilities permit. These tests should be conducted daily and, preferably, tests should be made at each station of the cream operation.

VISCOSITY. Factors contributory to the oiling off of cream are agitation and pumping. These are likewise destructive of the body or viscosity of the cream. It is a well known fact that the body of pasteurized and cooled cream is thinner than that of the original raw cream. Since viscosity is one of the characteristics on which bottled cream is judged by the consumer, various practices have been tried in an attempt to regain the viscosity lost through processing. These methods are based on cream tempering, addition of total solids, prolonged storage at cold temperatures, and homogenization. The cream tempering process was first described by Dr. Dahlberg; and more recently Dr. Ellenberger of Vermont has enlarged considerably on the original research. The heat treatment or heat tempering process involves heating the cold pasteurized cream to a temperature of about 80° F., holding for 10 to 20 minutes, and then slowly cooling. The entire procedure of heating, holding, and cooling occupies a period of about fifty minutes. Through this method, the original raw cream viscosity is attained and even surpassed. It must be considered, however, that every housewife heat-tempers her own cream on the back porch of her home, particularly in the summer time. Moreover, it has been our own experience that the viscosity of all cream approaches a constant when brought to a temperature of 52° F. Thus, when one considers the expense of the heating and cooling processes, the temperature of the environment, and that of the household icebox, the validity of this process is questioned.

Homogenization of cream has demonstrated its beneficial effect on viscosity, and its ability to maintain at a minimum the oiling off of cream. Research conducted at the University of Illinois has shown that homogenization at 300 lbs. to 400 lbs. pressure will increase the viscosity. Frozen cream should pass through the homogenizer to prevent oiling off in coffee. Homogenizing pressures above 400 lbs. will cause feathering in coffee.

Storage of cream at cold temperatures for 12 to 15 hours after bottling is con-

ductive to increasing in viscosity. This procedure is desirable if there is ample storage facilities.

Laboratory methods for determination of cream viscosity involve the use of viscosity pipettes or viscosimeters. The necessity of making line-run viscosity tests on cream is paramount.

Factors just discussed as being conducive to oiling off and to loss in viscosity of cream also induce serum separation. This separation in cream is aided by the amount of agitation and pumping pressure to which the cream is subjected. It is, therefore apparent that the less the cream is handled, the better is the viscosity and the less is the oiling off and serum separation.

PLUG FORMATION. If homogenization of the cream is practiced for the purpose of increasing the viscosity and reducing the fat separation, the possibility of plug formation under the cream cap is materially reduced.

WHIPPING ABILITY. The whipping ability of cream does not appear to be a function of viscosity, but rather that of proper conditions surrounding the whipping process. It has been our experience however, that the less the cream is handled, the easier it is to whip. The introduction and sale of equipment for whipping cream which involves the use of nitrous oxide or some other gas has not met with the success forecast by the distributors. The main criticism against the procedure is the inability of such whipped cream to hold up.

SUMMARY. Therefore, to control the quality of bottled cream it is essential that:

1. All factors on which cream is scored by the consumer should be considered when setting up a procedure for handling bottled cream.
2. All uses and abuses which the consumer exacts of the cream should be duplicated by the dairy control laboratory daily.
3. The homogenization of cream at reduced pressures is recommended for maintaining at

a minimum fat separation or oiling off, plug formation, and increasing viscosity.

4. Cream is like raw milk, the less it is handled the better.

MILK PLANT DESIGN AND FLY CONTROL.

The committee is in agreement that we should insist on separate rooms for receiving, pasteurizing, processing, cooling, bottling, and bottle washing. Smaller plants use one room for pasteurizing, cooling, and filling, but they should have a separate receiving room. In country receiving plants where the milk is taken in from producers, cooled, and shipped to large city plants for processing and bottling, there is no necessity for a separate receiving room when conveyors carry milk in cans direct to the weigh can, and when emptied cans are washed and delivered to truckman via another conveyor. Many plants wash cans in this room. The milk is carried to the pasteurizing room by a pipe line through wall. Some plants unload milk from trucks onto a conveyor. Cans pass on the conveyor through a flap door into the receiving room. Raw milk should not be hauled into pasteurizing room. Every time a door is opened, flies enter the room. All windows must be screened. All doors must be screened, and provided with proper spring to make them self-closing. Doors should open outward.

A one story plant or a one story plant with a balcony reduces the labor cost, which is a factor in the price of the finished product.

Conveyors for the raw milk should not be in the way of conveyors loading milk to the wagons or trucks for delivery, nor should they interfere with the unloading of returned milk from wagons or trucks.

Some plants use fans at opening flap from filler to chest to keep out flies. The same is true on flap from receiving room to pasteurizing room.

Quite a number of milk plants are using a spray preferably a spray without odor. A Mason jar of spray is inserted into steam line; the top of the jar carries an atomizer. When the plant is cleaned

up after the day's run, close all windows and doors and open steam or air valve. Next morning, sweep up the flies.

Various authorities state that the window space in each room should not be less than ten percent of the floor space in order to get proper light and ventilation and to prevent condensation.

Many plants use a suction blower in the wash room. It is inserted in the wall of this room for the purpose of carrying off steam out of plant.

The ventilation of plants in Canada is described by D. K. Douglass: Single story building, ventilate by half top of window sash for fresh air, and an outlet vent for foul air fitted with a control valve through roof to cupola; when pipe projects through roof, better drawing power is obtained and less draught and condensation if pipe is well insulated.

In larger plants, two or three stories, the outlet duct is fitted with an electrical fan where the pipe leaves the room to go outside, and extends up to outer walls, The inlet is the top sash of one or more windows. This problem could well be considered by our next committee, and the name of the committee could well be changed from Milk Plant Practice to Milk Plant Construction and Operation.

FRUIT JUICES IN MILK PLANTS

The city of Regina, Saskatchewan, Canada, has amended its by-laws to prohibit the processing of fruit juices in licensed dairies.

The amendment reads as follows:

"No products, other than milk and products of which milk is a substantial component, shall be handled or processed in a depot or milk house, unless equipment entirely separate from the equipment used in pasteurizing, handling or processing milk is used, and the handling or processing is carried on in a separate room."

I might add that Boston has practically the same set-up. Since our drive on dealers for separate equipment and rooms for orange drinks, a large company has installed a plant in Boston, and now processes and bottles this product for many of our small dealers.

This orange drink is flash pasteurized, cooled, and bottled with a metal tamper-proof cap. We have encouraged dealers to patronize this plant.

Some committee members believe that we are paying too much attention to this subject, and if we should just apply common sense sanitation to this problem we should not have any trouble.

INSTALLATION OF MILK PLANT FLOORS WITHOUT SHUTDOWNS

In some sections of the country we use metal grids, particularly where cement floor would be worn out by unloading and rolling jugs. With metal grids underneath portions of the floors, the latter can be repaired overnight.

Some committee members thought that plant should be shut down when a floor is installed, but this would not be necessary when a portion of a floor is to be laid.

WET SURFACE PAINTS FOR COLD ROOMS

Red lead and linseed oil have been used with a medium of success for painting pipes in the chest.

In the New England sections, two paints have been used for wet surfaces with fair success. One is Wet Wall Enamel. Basically it is made the same as other wall finishes and with practically the same raw materials, the liquid being long oil varnish, while the hiding pigments are combinations of zinc and lithopone, together with a third pigment that is absolutely inert but has a peculiar property of absorbing moisture. In fact, its real function in the material is to produce a surface that is moisture absorbent and porous until the varnishes have thoroughly oxidized. During the oxidizing period, this ingredient picks up the moisture that is on the surface and brings it to the surface of the new film, allowing the new paint to bond itself completely to the previous surface.

This paint is not recommended for use on surfaces that are reeking with water, but it will take care of jobs nicely where there is the natural condensation of a day's work to be contended with.

This material is furnished in three forms: a Primer, an Undercoat, and a Wet Wall Enamel. It is recommended that on new work, these materials be used throughout the entire finishing schedule. On old work, it may only be necessary to use the Undercoat and the Finishing Enamel, while on a surface where the paint is still in good condition, it is entirely probable that one and not more than two coats of the Finishing Enamel would give the results desired.

Another paint manufactured in New York has gained favor here. It is acid and water proof.

WASTE DISPOSAL AT COUNTRY PLANTS

This problem is usually cared for by town or city sewers, septic tanks. Where location is near a body of water, particularly rivers, a waste line is carried from the plant and well down the river so that wastes are properly diluted. Some states require that whey solids be taken out of milk when wastes are carried to rivers or lakes.

Plant wastes can be treated by four methods—mechanical, chemical, biological, and a combination of the three. Each plant is a separate problem.³

Every pound of milk containing about 12.5 percent solids requires about 3,000 gallons of the average stream water for dilution to maintain satisfactory stream conditions.⁴

Much milk solids come from can washers. This condition can be helped by collecting the drip. The equipment should be rinsed with water and effort should be made to recover the solids.

Irrigation: Spreading wastes on several acres of land that are kept under cultivation. Sandy soil is best adapted for this practice. Should odors become offensive, chloride of lime, sodium hypochlorite, or liquid chlorine may be applied to the waste before it is pumped

to the field. Small plants may haul wastes to land in more isolated districts by using a tank or trailer.

Filtration by gravel or crushed stone: The five day biochemical oxygen demand of the applied waste should not exceed 1,000 P.P.M., and an average of 700-800 P.P.M. is desirable.

Milk wastes have been the serious operating difficulties at sewage treatment works. When discharged untreated into municipal sewer systems, they must be diluted.⁵ The quantities and pollutional strengths of wastes produced by the same type as well as different types of milk plants vary considerably.

Properly designed and operated trickling filters built of crushed rock one to two inches in size, six to eight feet in depth and having a capacity of 80 cubic feet per pound of five day B.O.D. applied per 24 hours will normally reduce the pollutional strength of the wastes (as measured by the five day oxygen demand test) 80 percent or more.

REFERENCES

- (1) A. B. C. B. Educational Bulletin No. 1. Revised Edition.
- (2) Controlling the Quality of Retail Cream. Keenan, John A., Amherst Conference, July 1937.
- (3) Warrick, L. F. Food Conference M. I. T. September 1937.
- (4) Disposal of Wastes from Milk Plants. Eldridge, E. F. Special Bulletin 272—Michigan State College.
- (5) Milk Waste Treatments in Wisconsin. Ruff, H. and Warrick, L. F. Reprint from Sewage Works Journal, Vol. 4, No. 3, May 19, 1934.

A. R. TOLLAND, *Chairman*
 D. K. DOUGLAS
 H. C. ERICKSEN
 H. A. HARDING
 RALPH E. IRWIN
 J. R. JENNINGS
 C. B. MATTHEWS
 W. B. PALMER
 J. E. THOMSON.

The Quality Improvement of Creamery Butter

M. E. Parker, *Chairman*

Research Committee, American Butter Institute, Chicago, Ill.

SEDIMENT TEST

The development a few years ago in the laboratories of the United States Food & Drug Administration of a practical method for determining the sediment in butter provided the basis for realizing and unifying a national desire to improve the quality of the cream supplies used in the manufacture of creamery butter. The results of a sediment test are definite, readily understood, and subject to no equivocation. Therefore, when the sediment test for butter was applied, the urgent need for immediate attention to the quality of the cream supplies used in its manufacture was generally recognized. The industry was prompt to organize a nation-wide campaign, having as its objective the quality improvement of its raw cream supplies.

The government test for the determination of sediment in butter played a most important role in providing the cornerstone upon which the structure of the national quality improvement endeavor rests. The moment that the industry started to apply the sediment test to cream and butter, it embarked on a permanent effort. The market milk industry has used the sediment test for at least twenty years, and while other methods of analysis have since been developed which are more specific and comprehensive, the sediment test is still being applied to their raw milk supplies. We have been told by leaders in that industry that when the vigilance of sediment testing is relaxed, the sediment condition of their raw milk supplies declines even in these days of scientific enlightenment.

The Research Committee of the American Butter Institute conducted a national survey of methods for determining the sediment in cream and butter. This sur-

vey was conducted in a number of selected laboratories of commercial organizations and agricultural colleges wherein seasonal and sectional influences were studied. After one year's extensive study, involving over seven hundred samples of cream and more than two thousand samples of butter, it was ascertained that methods permitting the use of standard equipment used in the sediment testing of milk can be applied to cream and butter. Furthermore, it was established that the milk sediment standards can be applied equally as satisfactorily to cream and butter. The complete report of this investigation was published in the August 1937 issue of the *Journal of Dairy Science*. The American Butter Institute has adopted the Connecticut Official Milk Sediment Standards of 1931 for interpreting the results of sediment tests applied to cream and butter analyzed by its laboratory, and it is probable that the American Dairy Science Association will recommend similar methods for the sediment testing of cream and butter.

DEVELOPMENT OF THE INDUSTRY

In considering the problem of quality improvement, factors other than sediment are obviously involved. Before we consider them in detail, it might be well to discuss briefly something of the complexities and the extent of the creamery butter industry itself.

In the early nineties of the 19th century the development of the centrifugal separator, first successfully manufactured by Dr. DeLaval in 1886, provided the basis of the factory system in this country as his machine had reached the stage where it would be used on the farm. The introduction of these hand separators on the farm was slow at first, but it

gained considerable impetus in the course of a decade, particularly in the Middle Western states. The creamery butter industry was thus born with the advent of the farm separator, and the art was gradually revolutionized. The large centralized creameries secured their cream almost entirely from milk separated on the farms whereas the small local creameries had been receiving whole milk and separating the cream themselves.

These large centralizers, as they were called, gathered their supplies by a variety of procurement systems. Today, of the more than 4,000,000 farms in the United States, it is conservatively estimated that at least 2,000,000 are producing cream for buttermaking. Butter is being churned in approximately 4,500 creameries, most of which are located in the Middle West, where the distance of the producing farmer from his market varies from a few to many miles (e.g., 4 miles in Minnesota to 40-50 miles in Texas). Some creameries obtain their cream from a few while others draw from thousands of farms. As the industry has grown, competition has become increasingly intense because volume is essential to economic operation. These are all important facts to keep in mind in order to obtain a comprehensive picture of the creamery butter industry of the United States.

CONTROL PROBLEM OF MILK VERSUS CREAM

In recent years considerable attention has been directed toward the quality of the cream used in the manufacture of creamery butter. In the urban centers of our country, where the great bulk of creamery butter is consumed, the tendency has been to compare the production and handling of raw milk for market milk supplies with that of cream produced for butter-making. By so doing, not only have the historical and economical precepts upon which the butter industry is founded been disregarded but the fallacy of attempting to compare a local type of business with one operated on a substantially national scale has been overlooked.

It is generally known that the milk dealer has his regular patrons whose milk is produced under sanitary conditions, supervised either by local or state departments of health or both. Most consumers, however, do not realize that the quality problems of market milk supplies have been solved for that industry largely through the cooperative efforts of official health departments in educating and requiring the producing farmer to observe practical sanitary precautions. It is obviously possible to achieve the desired results more rapidly in a localized area where supervision is relatively simple. Incidentally, the cost for such improvement has been contributed in local taxes largely by the consumer. The creamery butter industry does not enjoy these advantages of such inexpensive means or ready control of quality improvement or maintenance. The major burden of such expense must be borne by the industry itself. In that connection, a price differential for quality has proven of benefit in improving raw cream supplies. The only effective means the creamery has of controlling quality is by appealing to the producer's pocketbook. It should be stated, however, that the U. S. Food & Drug Administration as well as state regulatory agencies have given the industry valuable assistance in quality improvement.

The problem of quality control is a huge undertaking inasmuch as the bulk of the cream used for buttermaking is produced in the more truly agricultural sections, where the rural population is less concentrated and the farms are not only more widely separated, but do not specialize in dairying. It is doubtful under such circumstances that supervision, either by the industry or regulatory agencies, can ever be as intensive or effective as in the case of market milk supplies. The economic burden alone will preclude any elaborate inspection service.

MANUFACTURING FACTORS

We have referred to "the art of buttermaking." This is an ancient art which has been revolutionized by the factory system. The artisan's skill is still of para-

mount importance, and in that respect, buttermaking differs significantly from the handling and processing of market milk which is largely subject to technological control. Today, the common experience is that nothing will reveal the differences of opinion among buttermakers more readily than a discussion of the production practices involved in preparing cream for churning. These differences are not based entirely upon the whims or caprices of individual buttermakers, for seasonal and sectional influences make it necessary in processing different cream supplies to vary and adjust the degree and type of production practices. The skill of the artisan is still a vital factor.

The areas in which climatic conditions and density of dairy development contribute most to relative ease in the production of the highest grades of butter are comparatively small. Their output comprises not the largest proportion but probably twenty-five percent of all creamery butter made in the United States. The remaining seventy-five, or possibly, eighty percent is produced in areas with widely divergent climatic conditions and degrees of dairy development.

MARKETING FACTORS

Not only in the manufacture of butter is it evident that empirical methods play an important part, but in its marketing also, they assume a paramount role. This is the common trade practice of scoring or grading butter. Butter has been graded for years by the skilled taste senses of commercial and official judges on the arbitrary and numerical basis of 45 points for flavor, 25 for body, 15 for salt, 10 for color and 5 for appearance of package. This method has now been superseded by a new official rating procedure, described in the May issue of this Journal. Such procedure of rating merits and defects might be criticized because it does not take the judgment of butter quality out of the field of human error. On the other hand, in judging the quality of any food product, the consumer is guided by the character of its taste and aroma as well as by the attractiveness of its sales

price and the appeal of its appearance. In merchandising its product, the butter industry is confronted with consumer physiological and psychological preferences which it can ill afford to ignore in passing judgment upon the results of its own labor.

Butter produced in Kansas will have different characteristics from that churned in Minnesota, although both will be equally nutritious and wholesome. Similarly, consumer preferences in New York will differ from consumer preferences in New Orleans. This explains why butter scoring 90 points (or standard quality) in one market may be accorded 92 points (or extra quality) in another. It is for these reasons that commercial judges instinctively consider the source of production and the market when they grade butter. They also attempt to predict keeping quality in order to retain consumer acceptance.

ECONOMIC FACTORS

Economic precepts and trade customs are recognized as not being your major concern. They are herewith presented to reveal the forces with which the industry has to cope. These forces cannot be disregarded without bringing disaster to the industry and to the agricultural interests upon which it is based. This is no plea for laxity in sanitation but rather a caution that we cannot contribute to a profitable and stable agricultural development if we deprive the farmer of an opportunity to market his cream, providing it is clean and wholesome. In that connection, the procurement of raw supplies in the creamery butter industry involves systems where the distance from market bears a direct relation to quality. Incidentally, this reference to "the distance from market" is used broadly and involves not only the actual physical measurement in miles but includes also the influence of age.

The solution of cream quality lies in the direction of cleanliness, proper cooling, and frequent delivery. Cleanliness applies both to milk and also to cream. Proper cooling in a milk shed might mean

mechanical refrigerating equipment, but in a cream producing area it cannot mean much more than cooling with well water plus inexpensive protection enroute to market. Proper delivery in a milk shed means daily pick-up, whereas in a cream producing area it means less frequent delivery. Therefore, when these relative terms are analyzed, they are seen to have quite a different meaning. Cream prepared on the farm is bound to reach a creamery with a varying development of acidity, dependant upon seasonal and sectional influences as well as its "distance from market."

NEED FOR NEW TEST

What the industry needs now is some test as relatively simple as the acidity test or the Babcock test that will detect cream of inferior quality. Many investigators have attempted to correlate amino nitrogen content with the quality of cream and its resulting butter, but without significant success. Possibly one of the reasons for failure is found in the results of recent studies of the ammonia production in milk conducted by Perkins of the Ohio State University. While the amount of ammonia in fresh milk is usually quite small, bacterial growth probably accounts largely for its development. What is more important, the bacterial species capable of producing the greater amounts of ammonia is *Streptococcus lactis*. This organism is always present in overwhelming numbers in sour cream, and generally is considered to be a retarding influence to contaminants which might possess proteolytic properties. In fact, contrary to the generally accepted idea, the liquefying type of bacteria do not begin to produce ammonia as effectively as *Streptococcus lactis*. Consequently we cannot expect much aid in detecting quality in cream

and butter by determining its amino nitrogen content. Until we develop more exact means, we shall have to continue to use the senses of taste and smell.

During the past two years, the Research Committee of the American Butter Institute has studied various methods of analyzing butter and related products. After thorough investigation, it was decided to prepare a manual of laboratory methods to be available to all interested parties. This manual contains the methods used by the laboratory of the American Butter Institute. (Editor: This manual can be purchased from the American Butter Institute, Chicago, Ill. Price \$1.00.)

CHARACTER OF CONTROL PROBLEM

The quality improvement of creamery butter is a permanent responsibility which the industry and health officials both must recognize and share. The ultimate goal of clean, cool cream delivered frequently has not yet been fully realized, although appreciable progress has been made during recent years. Changing the habits of at least 2,000,000 farmers is quite a task. Possibly some may feel that while progress has been gradual, it has still been far too slow. Yet any health official who has been engaged in the quality improvement of market milk supplies for the past twenty years will recognize that history is repeating itself. The creamery butter industry is now at the stage of development that the market milk industry held in the early days of its quality improvement. Furthermore, there is the contrast between a purely local type of business and one that is national in scope and operation. This will require differences in the methods for the effective and lasting quality improvement of creamery butter.

Fiber That Looks Like Wool Can Be Made From Skim Milk

A synthetic fiber having the appearance of wool can be manufactured from casein, a milk byproduct, by a process devised by Stephen P. Gould and Earl O. Whittier of the Bureau of Dairy Industry, U. S. Department of Agriculture. The process is similar to that used in making viscose rayon from cellulose, and public service patents, applied for by the Bureau, are pending.

In Italy, where a somewhat different process for making casein fiber was announced three years ago, production is already on a commercial scale. Most of the fabrics, however, are half synthetic fiber and half wool.

To make the fiber, casein is softened in water and dissolved in a solution of caustic alkali. It becomes a thick, sticky mass and is carefully worked into the proper consistency by aging, addition of modifying agents, and dilution. The mass is then forced through multiple spinnerets of the kind used in making rayon. The fibers are separated and hardened in an acid bath containing formaldehyde and modifiers.

Synthetic fiber produced in this manner has a chemical composition almost identical with wool except for a lower sulphur content. The fiber is faintly yellow in color and closely resembles best grade thoroughly washed and carded Merino wool, the finest size marketed. The casein fiber has the characteristic fine kink of natural wool and may be blended with it to make a product that has the resilience of pure wool. Synthetic fibers with this kinky structure have been made from plant materials recently, but since they do not take wool dyes, they are not as desirable as fibers from animal products for blending with wool.

Because the fibers are smooth, rather than scaly like natural wool fibers, they cannot be felted. For the same reason,

however, the synthetic fiber does not shrink as much as wool. By varying the acid bath in manufacture, the fiber may be made either soft or harsh to the touch. The softer grades, while not as strong, make up into knitted garments which may be worn next to a sensitive skin which cannot tolerate knitted wool.

Both the fineness and the length of the synthetic fiber may be regulated in the manufacturing process, the bureau scientists point out, giving it an advantage over wool in this respect.

Because casein fiber has been produced in this country only on an experimental basis, commercial costs have not been definitely determined. Gould and Whittier believe, however, that it can be manufactured to be sold at a price on par with that of rayon, which is about 50 cents a pound. Although casein usually sells for 10 to 15 cents a pound, compared with about 5 cents a pound for cellulose, agents used in treating casein fibers are cheaper than those used in making rayon. In addition, the chemical used in the casein process may be used over and over again, while that used for rayon manufacture cannot. The processes of manufacture are so similar that rayon plants can easily manufacture synthetic wool merely by using casein instead of cellulose and changing the modifying agents.

Casein is made from skim milk and the United States already produces about 35 million pounds annually. It is used principally as a paper coating and in the manufacture of plastics, such as billiard balls. Because of the almost unlimited supply of skim milk available in this country it is possible to produce as much as one billion pounds of casein annually. This is approximately equivalent to one billion pounds of casein fiber.

A Special Invitation To Milk Sanitarians To Attend the Dairy Industries Exposition

Roberts Everett,

*Executive Vice-President, Dairy & Ice Cream Machinery & Supplies Association,
New York, N. Y.*

No registrant is more welcome at the Dairy Industries Exposition than the health officer interested in milk, or the commercial milk sanitarian.

In some form as old as human enterprise, the dairy industries have always been inevitably subject to sanitation's natural laws.

Today dairy products manufacturers, and the manufacturers and distributors of machinery and equipment and supplies for the dairy products industries, know that these natural laws of sanitation have become known more and more scientifically. Milk research has revealed and still reveals them. Milk sanitarians convey the knowledge of them to the industries and to the public.

Men in the milk industries are as eager to have their operations unimpeachable in terms of sanitation as are the most conscientious health authorities. General executives and operating executives are prompt to take advantage of the information which the commercial milk sanitarians possess.

Often there are different viewpoints. There are those which the operating executives in the milk industries refer to as "purely regulatory" or "too technical." There are also those which the regulatory sanitarians often refer to as "purely practical" or "too commercial." Often, advanced public health objectives, the simp-

ler and more rapid development of the dairy industries, and a more economical provision of milk and its products to the consumer result from an honest effort by those who hold these different viewpoints to explain them thoroughly, each to the other, and by rational procedures to reach a common ground.

At the Dairy Industries Exposition, owners and executives of milk and milk products companies — designers and manufacturers and distributors of machinery, equipment, supplies, materials, and services—regulatory sanitarians, and commercial sanitarians—all can meet in a common interest. The Dairy Industries Exposition this year, in Cleveland, October 17th to 22nd, is concurrent with the twenty-seventh annual convention of the International Association of Milk Sanitarians; and it will afford all milk sanitarians who attend the most comprehensive examination of milk industrial "tools" that will ever have been brought together.

The Dairy Industries Exposition and the Dairy and Ice Cream Machinery and Supplies Association, which makes the Exposition possible, especially and cordially invite to the Show this year all members of the International Association of Milk Sanitarians and all other milk sanitarians regardless of their affiliations.

Cleveland—Our Convention City

H. O. Way, *Chairman*

When we gather for the 1938 session of the International Association of Milk Sanitarians in Cleveland, Ohio, October 19 to 21, it will be in one of the most beautiful settings in America. October on the south shore of Lake Erie presents a picture of serenity and grandeur. Lake breezes temper the climate from the extremes of summer and winter.

From a little frontier trading post in the Western Reserve, laid out by General Moses Cleaveland in 1796, it has grown to be not only the metropolis of the great state of Ohio, but the home of more than a million people, the capitol of a great trade empire within 150 miles of which live 10,245,000 people. Half the population of the United States and Canada live within an over-night ride from Cleveland.

Here Pennsylvania coal, Ohio limestone, and Lake Superior iron ore meet in the great iron and steel industry which together with paint manufacture, oil, men's clothing, women's apparel, knit goods, electrical machinery and appliances, brick, rayon, chemicals, and a great variety of miscellaneous items make up an annual industrial output approaching well toward a billion dollars in value. These products are shipped to all parts of the world; blast furnace equipment to China and Russia, wire screen to South Africa and South America, trucks to Australia and China, paint to Italy, locomotives to India, and telescopes to some of the most famed astronomical observatories in the world.

Cleveland's educational facilities are of the best. In addition to over 300 public, parochial, preparatory, and high schools, it is the seat of Western Reserve and John Carrol Universities, Case School of Applied Science, and Fenn College, with Baldwin Wallace College located 15 miles southwest at Berea. At the University center, on eastern Euclid Avenue,

Case School neighbors with Western Reserve University with its many schools and University Hospital group, Medical Library, Institute of Pathology, and Severance Hall, the home of the Cleveland Symphony Orchestra. Co-operating closely with these institutions are the Western Reserve Historical Society, the Art Museum, the Museum of Natural History, and the great Cleveland Public Library.

Euclid Avenue, once the famous "most beautiful street in the world", has given way to business; but in its stead have come thousands of beautiful homes in the suburbs which properly replace the mansions on "the Avenue." In this, Cleveland Heights, Shaker Heights, Lakewood, and Rocky River are noteworthy.

Early in its history, Cleveland won the nickname "Forest City." It has aimed to maintain this throughout a substantial

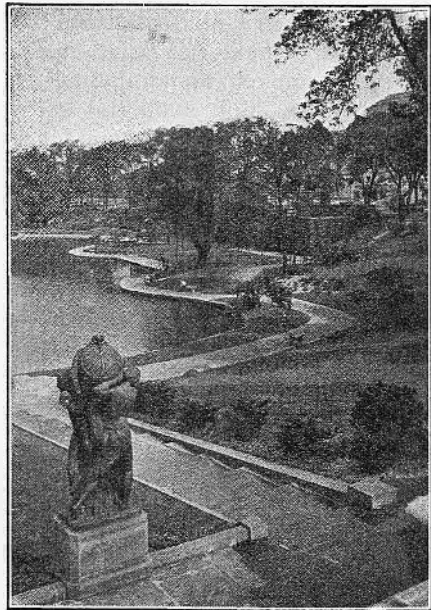

Art Museum

industrial growth. Its many beautiful parks are a testimony to its success, prominent among which is the great Metropolitan Park system forming a U about the city and its suburbs. The Public Square, in the heart of the city, purchased by the Connecticut Land Co. in 1795 for \$1.76 is now reputed to have a cash value of \$20,000,000. From this square, serving as a hub, streets and street car lines radiate like spokes of a wheel to all parts of the city. In the southwestern corner of the Public Square is the Terminal Tower and its affiliated buildings. On top of this building, 52 stories in height (750 feet), an observation porch enables one to see for many miles about the city and lake.

During the week of our convention, the Dairy show will be held in the Public Auditorium. This was built at a cost of \$15,000,000, to accommodate 16 events at the same time, without interference. The main auditorium, seating 12,500 people, can be joined with the music hall to hold 16,000 persons. The pipe organ costing \$100,000, has 10,010 pipes

and 150 stops. The echo organ is located 300 feet from the console.

Cleveland's transportation facilities, by highway, rail, air, and water are among the best. U. S. Route 20, the main thoroughfare between Boston, Chicago and the West passes through Cleveland. The Lakes-to-Sea Highway U. S. Route 322, also U. S. Route 422, enter from the east and southeast, U. S. Route 21 extends south to Florida, while State Route 3 and Route 42 lead from the southwest. With the exception of the Erie and Pennsylvania, which have their own depots, all passenger trains enter the Union Terminal at the southwest corner of the Public Square. The Cleveland Air Port, embracing 1040 acres on Rocky River Drive in the western section of the city is said to be one of the largest and finest in the world.

Lake Erie affords excellent facilities for travel and transportation. Two thirds of all the American vessels on the Great Lakes are owned or operated by Cleveland interests. Cleveland has over 14 miles of lake frontage. Its harbor is pro-



Terminal Tower Group

tected by a breakwater nearly 6 miles in length. The passenger boat landing occupies a portion of the lake front development which it shares with the new Stadium, an out-of-door arena where many events, from ball games to grand opera, are held in suitable weather; and the park area on which the Great Lakes Exposition was held in 1936 and 1937. This will also be the site of the World Poultry Congress in 1939. A new Lake Front Drive has been opened recently. This extends eastward and forms a convenient entrance to the city from U. S. Routes 6 and 20.

The week of October 17 to 22, in Cleveland, will be a period of unusual opportunity for those interested in the milk industry. The Dairy Industries Exposition will be held throughout the week in the Public Auditorium. The International Association of Milk Dealers, The International Association of Ice Cream Manufacturers and the Independent Ice Cream Manufacturers all meet during the week. In addition to this, plans for bet-

CHARLES E. REINHOLT
Manager

HOTEL ALLERTON
CHESTER AVE. AT E. 13TH STREET

ter acquaintance of members and especially for entertainment of the ladies are in progress. Remember all roads lead to Cleveland. Come to Cleveland October 19 to 21.

H. O. WAY,
Chairman, Local Committee.

Allerton Hotel Rates

Rates:—

Type	Single	Double
Running water	\$1.75	\$2.75
Running water and lavatory.....	2.00	3.25
Private bath (double beds).....	2.50	4.00
Private bath (twin beds).....	3.00	4.50
Suite—living, bedroom, and bath.....	7.00

4 persons in a 2 room suite with bath, \$2.00 each person.

4 persons in a 2 room suite without bath, \$1.35 each person.

Send your reservations immediately to the Hotel Allerton, Cleveland, Ohio.



Severance Hall

Tentative Program of the 1938 Convention

INTERNATIONAL ASSOCIATION OF MILK SANITARIANS

October 19-21, 1938

October 19

WEDNESDAY MORNING

Resazurin Tests.

M. A. Collins,

*United Farmers Cooperative Creamery
Boston, Mass.*

Phosphatase Test for By-Products.

Harry Scharer,

*Bureau of Laboratories,
New York City Health Department*

Tests and Testing.

H. C. Goslee,

*Dairy and Food Commission,
Hartford, Conn.*

Homogenized Milk.

C. J. Babcock,

*U. S. Department of Agriculture,
Washington, D. C.*

WEDNESDAY AFTERNOON

**Joint session with laboratory and
plant directors of the International
Association of Milk Dealers.**

An Evaluation of the Various Procedures
for Making Phosphatase Tests.

L. H. Burgwald,

*Ohio Agricultural Experiment Station,
Wooster, Ohio.*

Practical Applications of the Phosphatase
Test.

D. M. Roger,

*The Borden Company,
New York City.*

Short Time Pasteurization.

(a) Milk Company's View

W. D. Dotterrer,

*Bowman Dairy Co.,
Chicago, Ill.*

(b) Sanitarian's View.

Paul F. Krueger,

*City Health Department,
Chicago, Ill.*

State Sanitary Control—Maximum and
Minimum Requirements.

Charles McDonald,

Health Department, Akron, Ohio.

WEDNESDAY EVENING

New Zealand-Dairying (with colored
movies).

G. J. Hucker,

*New York State Agricultural Experi-
ment Station,
Geneva, N. Y.*

Report of the Committee on Communica-
ble Diseases Affecting Man.

I. A. Merchant, Chairman

*Iowa State College,
Ames, Iowa.*

Milkborne Outbreaks.

Paul B. Brooks,

*State Department of Health,
Albany, N. Y.*

Trends of Milk Control in Texas.

T. H. Butterworth,

Lubbock, Texas.

October 20

THURSDAY MORNING

Measuring the Bacteriological Quality of Milk.

C. K. Johns,

*Department of Agriculture,
Ottawa, Canada.*

Nutritional Properties of Milk.

C. P. Segard,

*Wisconsin Alumni Research Founda-
tion, New York City.*

BUSINESS SESSION.

THURSDAY AFTERNOON

Seeing the Dairy Show.

THURSDAY EVENING

Report of the Committees on Dairy and Milk Plant Equipment and Sanitary Procedure.

W. D. Tiedeman, Chairman

*State Department of Health,
Albany, N. Y.*

Milk Bottle Design with reference to "Pouring Lip".

Lloyd Arnold,

*University of Illinois,
Urbana, Ill.*

Paper Milk Containers.

F. W. Tanner,

*University of Illinois,
Urbana, Ill.*

October 21

FRIDAY MORNING

Report of Committee on Methods of Improving Milk Supplies in Small Communities.

Leslie C. Frank, Chairman

*U. S. Public Health Service,
Washington, D. C.*

Testing of Bottle Washing Solutions.

C. M. Moore,

*The Diversey Corporation,
Chicago, Ill.*

Mastitis.

Speaker not selected.

Effectiveness of Milk Control.

R. W. Tyler,

*Ohio State University,
Columbus, Ohio.*

ADJOURNMENT

Convention Notes

Hotel accommodations should be made immediately. During the period of the dairy show, hotel rooms are at a premium. The Hotel Allerton, headquarters of this association, has postponed reserving all their rooms until now in order to give our members an opportunity to stay there.

Our program allows half a day for visiting the Dairy Industries Exposition. This is really not sufficient time to see an exhibit of this magnitude. It is suggested that members go a day early so as to see the dairy show without taking time from our meetings.

If there is any information wanted concerning hotel reservations, entertainment, or any other questions of local concern, the members may communicate with Mr. H. O. Way, 308 Western Reserve Building, Chairman of the Local Committee on Arrangements.

New Food Standards Committee

The new Food, Drug, and Cosmetic Act of June 25, 1938, authorizes the appointment of a food standards committee to formulate definitions and standards both of identity and of quality, including fill of container, after consideration of all the data—analytical and inspectional—deemed essential to support them. This committee will meet in the Food and Drug Administration in Washington at intervals to review the data which have been assembled, draft tentative standards, hold public hearings, and then make their recommendations to the Secretary of Agriculture. Under the new act, these definitions and standards when promulgated by the Secretary, will have the full force and effect of law.

The food standards committee, which has heretofore functioned in formulating standards for only administrative guidance, will be perpetuated. Its tri-partite form will be maintained. The members are as follows:

For the Association of Official Agricultural Chemists: C. D. Howard, Director and Chief, Division of Chemistry and Sanitation, State Board of Health, Concord, N. H.; Guy G. Frary, State Chemist, Vermilion, South Dakota.

For the Association of Dairy, Food, and Drug Officials of the United States: J. J. Taylor, State Chemist, Department of Agriculture, Tallahassee, Florida; Mrs. F. C. Dugan*, Director Bureau of Foods, Drugs, and Hotels, State Board of Health, Louisville, Kentucky.

For the Food and Drug Administration: W. B. White, Chief, Food Division; W. S. Frisbie, Chief, Division of State Cooperation.

* Member of the International Association of Milk Sanitarians.



Advertising
in this Journal
presents
YOUR STORY
to the
**LEADING MILK
SANITARIANS**
in both Official
and
Industrial
organizations



JOURNAL OF MILK TECHNOLOGY

Official Publication of the

International Association of Milk Sanitarians

(Association Organized 1911)

Editors

W. B. PALMER, *Managing Editor*
Orange, N. J.

J. H. SHRADER, *Editor*
East Orange, N. J.

Associate Editors

C. A. ABELE
Montgomery, Ala.

SARAH VANCE DUGAN
Louisville, Ky.

J. G. HARDENBERGH
Plainsboro, N. J.

M. A. HEINZMAN
Ventura, Cal.

J. A. KEENAN
Boston, Mass.

C. K. JOHNS
Ottawa, Canada.

ERNEST KELLY
Washington, D. C.

P. F. KRUEGER
Chicago, Ill.

H. N. PARKER
Jacksonville, Fla.

M. E. PARKER
Chicago, Ill.

G. W. PUTNAM
Chicago, Ill.

H. R. THORNTON
Edmonton, Alberta, Canada

The JOURNAL OF MILK TECHNOLOGY is issued bimonthly beginning with the January number. Each volume comprises six numbers. It is published by the International Association of Milk Sanitarians, and is printed by The Chronicle Press, Inc., Orange, N. J., U. S. A.

Subscriptions: The subscription rate is \$5.00 per volume.

Advertising: All correspondence concerning advertising, reprints, subscriptions, and all other business matters should be addressed to the Managing Editor, W. B. Palmer, 29 North Day Street, Orange, N. J.

Manuscripts: All correspondence regarding manuscripts, editorials, news items, announcements, and other reading material should be addressed to the Editor, J. H. Shrader, 339 Springdale Avenue, East Orange, N. J.

Membership and Dues: Active and Associate Memberships in the Association are \$5.00 per year. This includes all issues of the Journal. All correspondence concerning membership in the INTERNATIONAL ASSOCIATION OF MILK SANITARIANS, including applications for membership, remittances for dues, failure to receive copies of the JOURNAL OF MILK TECHNOLOGY, and other such matters should be addressed to the Secretary of the Association, C. Sidney Leete, State Department of Health, Albany, N. Y.



Why Take Chances?
*... on cleaning when
 the protection of Wyandotte
 Quality costs so
 little?*

Wyandotte Cleaner and
 Cleanser is fast, non-caus-
 tic, safe. Gives surfaces
 properly cleaned for effec-
 tive sterilization.

Sterilizing after Cleaning

Wyandotte Steri-Chlor kills bacteria without harm to metals, rubber, brushes or fabrics. Powder makes clear solution in hard water or soft, ready instantly for use. Safe—sure.

5 and 10 lb. Cans—25-50-350 lb. Drums

*There is a Wyandotte
 Dealer—and a Service
 Representative in your
 vicinity. Always at
 your Service.*

Wyandotte,
Michigan

THE J. B. FORD CO.

Wyandotte

*Specialized Cleaners
 & Alkalies*



- Milk Sanitarians
- Industrial Quality Control Officers
- Medical Milk Commissions
- Milk Plant Operators
- Milk Control Officials
- Dairy Technologists
- Laboratorians
- Veterinarians

KEEP ABREAST

of the new developments in milk technology through the

Journal of Milk Technology

Join the
 International Association of Milk Sanitarians

See page 56 for particulars

When writing to advertisers, say you saw it in this Journal.

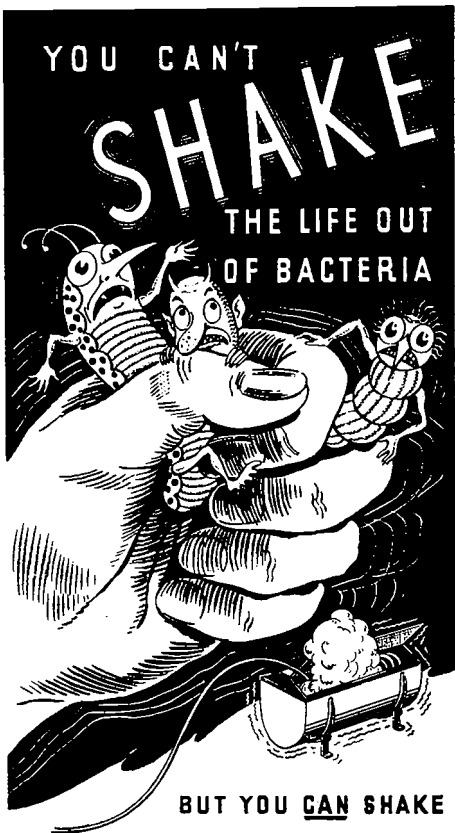

The constant throbbing of live steam in a vat of water eventually opens up seams, loosens fittings and causes costly repairs. Doubly expensive . . . uncertain in results . . . heat sterilization is today being replaced in most dairy plants by dependable, economical Diversol.

Diversol kills bacteria quickly, quietly . . . without injury to equipment . . . and at a fraction of the fuel cost for steam or hot water. Unlike ordinary sterilizers Diversol never corrodes or damages equipment. Easy to use. Keeps its strength. Order a trial drum of Diversol, today . . . it's the safe way to save on sterilizing costs.

THE DIVERSEY CORPORATION

53 W. Jackson Blvd., Chicago, Ill.



DIVERSOL

KILLS BACTERIA IN COLD WATER

Index to Advertisers

	PAGE NO.
Aluminum Seal Company.....	IV
Borden	IV
Cherry-Burrell Corporation	VI
Creamery Package Company.....	V
Difco Laboratories.....	Back Cover
Diversey Corporation	VIII
Ford Co., The J. B.....	VII
Standard Cap and Seal Corp.....	II
Sealtest, Inc.	IX
Vitex	III

THE SEALTEST SYMBOL

The Sealtest Symbol has grown to mean much to many families throughout the nation. Careful housewives, today, are demanding a high degree of scientific supervision over the dairy and ice cream products they buy—and are insisting that their children take the same care in their daily purchases at school or from the stores. Through a high type of advertising campaign in publications and on the radio, Mrs. America has gained a new knowledge of what Sealtest means. Her use of Sealtest-approved products has verified this knowledge. That is why the Sealtest Symbol, today, signifies to her a scientific assurance of quality and wholesomeness, in the dairy and ice cream products she uses.

The Sealtest System of Laboratory Protection was formed by a group of leading affiliated dairy and ice cream companies—both the System and the companies being under one common ownership.



SEALTEST, INC., 120 Broadway, New York



CENTER FOR RESEARCH LIBRARIES



BACTO-MALT AGAR

FOR DETECTION AND ENUMERATION OF MOLDS

Bacto-Malt Agar is recommended for determining the mold and yeast count of butter and other dairy products. It is also widely used for detecting sources of contamination by these organisms and for controlling the sanitary conditions of manufacture at different stages of manufacture.

The dehydrated medium is readily prepared for use by suspending the powder in water, boiling for a few minutes to dissolve the agar and then sterilizing the solution. No filtration of the medium is required. After the usual autoclave sterilization the medium will have a reaction of pH 5.5. A more acid reaction, capable of suppressing bacterial growth, may be obtained by adding Lactic Acid as specified on the label of each bottle.

Results obtained upon plates of medium prepared from Bacto-Malt Agar are reliable, accurate and comparable because the medium is always uniform in its composition. It is exceptionally stable in its dehydrated form and may be used over a long period of time or in various laboratories with excellent satisfaction.

Specify "DIFCO"

THE TRADE NAME OF THE PIONEERS

In the Research and Development of Bacto-Peptone and
Dehydrated Culture Media

DIFCO LABORATORIES

INCORPORATED

DETROIT, MICHIGAN