

Journal of

MILK and FOOD TECHNOLOGY.

56TH ANNUAL MEETING
August 18, 19, 20, 21, 1969
Brown Hotel
Louisville, Ky.

Official Publication

International Association of Milk, Food and
Environmental Sanitarians, Inc.

THE ONLY Approved
SANITARY METHOD OF APPLYING
A U. S. P. LUBRICANT
TO DAIRY & FOOD
PROCESSING EQUIPMENT

*Haynes
Spray*

U. S. P. LIQUID PETROLATUM SPRAY

U.S.P. UNITED STATES PHARMACEUTICAL STANDARDS

CONTAINS NO ANIMAL OR VEGETABLE FATS. ABSOLUTELY
NEUTRAL. WILL NOT TURN RANCID—CONTAMINATE OR
TAINT WHEN IN CONTACT WITH FOOD PRODUCTS.

SANITARY—PURE

ODORLESS—TASTELESS

NON-TOXIC

The Modern HAYNES-SPRAY Method of Lubrication
Conforms with the Milk Ordinance and Code
Recommended by the U. S. Public Health Service

The Haynes-Spray eliminates the danger of contamination which is possible by old fashioned lubricating methods. Spreading lubricants by the use of the finger method may entirely destroy previous bactericidal treatment of equipment.

PACKED 6-12 oz. CANS PER CARTON
SHIPPING WEIGHT—7 LBS.

THE HAYNES MANUFACTURING CO.
4180 Lorain Avenue • Cleveland 13, Ohio

HAYNES-SPRAY INGREDIENTS CONFORM WITH FDA REGULATIONS AND CAN BE SAFELY USED AS A SANITARY LUBRICANT FOR FOOD PROCESSING EQUIPMENT WHEN USED IN COMPLIANCE WITH A EXISTING FOOD ADDITIVES REGULATION.



This Fine
Mist-like
HAYNES-SPRAY
should be used to lubricate:
SANITARY VALVES
HOMOGENIZER PISTONS — RINGS
SANITARY SEALS & PARTS
CAPPER SLIDES & PARTS
POSITIVE PUMP PARTS
GLASS & PAPER FILLING
MACHINE PARTS
and for ALL OTHER SANITARY
MACHINE PARTS which are
cleaned daily.

HAYNES SNAP-TITE GASKETS

"FORM-FIT" WIDE FLANGE
HUGS STANDARD BEVEL
SEAT FITTINGS

MOLDED TO
PRECISION STANDARDS

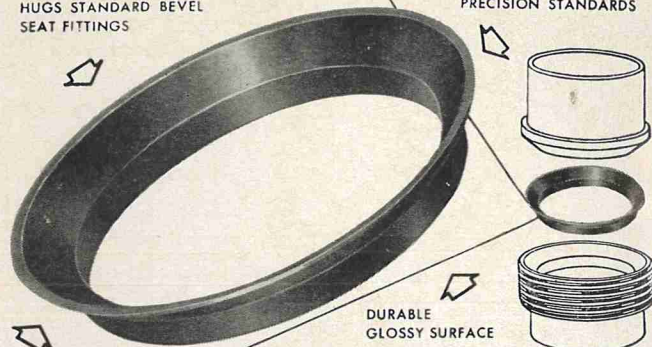

DESIGNED TO
SNAP INTO
FITTINGS

DURABLE
GLOSSY SURFACE

▶ **LOW COST...RE-USABLE**

▶ **LEAK-PREVENTING**

NEOPRENE GASKET for Sanitary Fittings

Check these **SNAP-TITE** Advantages

Tight joints, no leaks, no shrinkage

Sanitary, unaffected by heat or fats

Non-porous, no seams or crevices

Odorless, polished surfaces, easily cleaned

Withstand sterilization

Time-saving, easy to assemble

Self-centering

No sticking to fittings

Eliminate line blocks

Help overcome line vibrations

Long life, use over and over

Available for 1", 1½", 2", 2½" and 3" fittings.

Packed 100 to the box. Order through your dairy supply house.

THE HAYNES MANUFACTURING CO.
4180 Lorain Avenue • Cleveland 13, Ohio



HAYNES
SELF-CENTERING
SNAP-TITE
Gaskets

* MADE FROM
TEFLON®

SIZES 1" - 1½"
2" - 2½" - 3"

"The Sophisticated Gasket"
THE IDEAL UNION SEAL FOR
BOTH VACUUM AND
PRESSURE LINES

Gasket Color . . .
slightly off-white

SNAP-TITE self-centering gaskets of TEFLON are designed for all standard bevel seat sanitary fittings. They SNAP into place providing self-alignment and ease of assembly and disassembly.

HAYNES SNAP-TITES of TEFLON are unaffected by cleaning solutions, steam and solvents. They will not embrittle at temperatures as low as minus 200° F. and are impervious to heat up to 500° F.

FOR A FITTING GASKET THAT WILL OUT-PERFORM ALL OTHERS...

Specify . . . **HAYNES SNAP-TITES of TEFLON**

• TEFLON ACCEPTED SAFE FOR USE ON FOOD & PROCESSING
EQUIPMENT BY U. S. FOOD AND DRUG ADMINISTRATION

* Gaskets made of DuPont TEFLON® TFE-FLUOROCARBON RESINS

THE HAYNES MANUFACTURING COMPANY
4180 LORAIN AVENUE • CLEVELAND, OHIO 44113

A HEAVY DUTY SANITARY LUBRICANT



Available in both
SPRAY AND TUBE

All Lubri-Film ingredients are approved by F.D.A. and can be safely utilized as a lubricant for food processing equipment when used in compliance with an existing food additive regulation.

ESPECIALLY DEVELOPED FOR LUBRICATION OF FOOD
PROCESSING AND PACKAGING EQUIPMENT

For Use in Dairies — Ice Cream Plants — Breweries —
Beverage Plants — Bakeries — Canneries — Packing Plants

SANITARY • NON TOXIC • ODORLESS • TASTELESS

SPRAY — PACKED 6 — 16 OZ. CANS PER CARTON
TUBES — PACKED 12 — 4 OZ. TUBES PER CARTON

THE HAYNES MANUFACTURING CO.
CLEVELAND 13, OHIO

Your Hospitality Host...

Welcomes you

to

Louisville!

August 17, 18, 19, 20, 21

**International Association of
Milk, Food and Environmental Sanitarians, Inc.**

A visit to Louisville's World-Famous Brown Hotel with its decorative surroundings, enhanced facilities, combined with traditionally fine service becomes an unforgettable experience.



Please make reservations as follows:

Name _____

Address _____

Date of Arrival _____ Date of Departure _____

RESERVE	Check Here
Single Room (One Person)	Rate
Double Room (Two Persons)	Rate
Parlor Suites	Rate

ENTIRE HOTEL COMPLETELY AIR CONDITIONED

RATES	
Single	8.50 to 14.00
Double	12.00 to 20.00
Parlor Suites	From 24.00

**FREE PARKING
for
OVER NIGHT
GUESTS**

*SPECIAL RATES — \$10.00 Single and \$15.00 Twin for Members on Per Diem.

BE OUR GUEST AT THE

BROWN HOTEL

FOURTH STREET AT BROADWAY IN LOUISVILLE



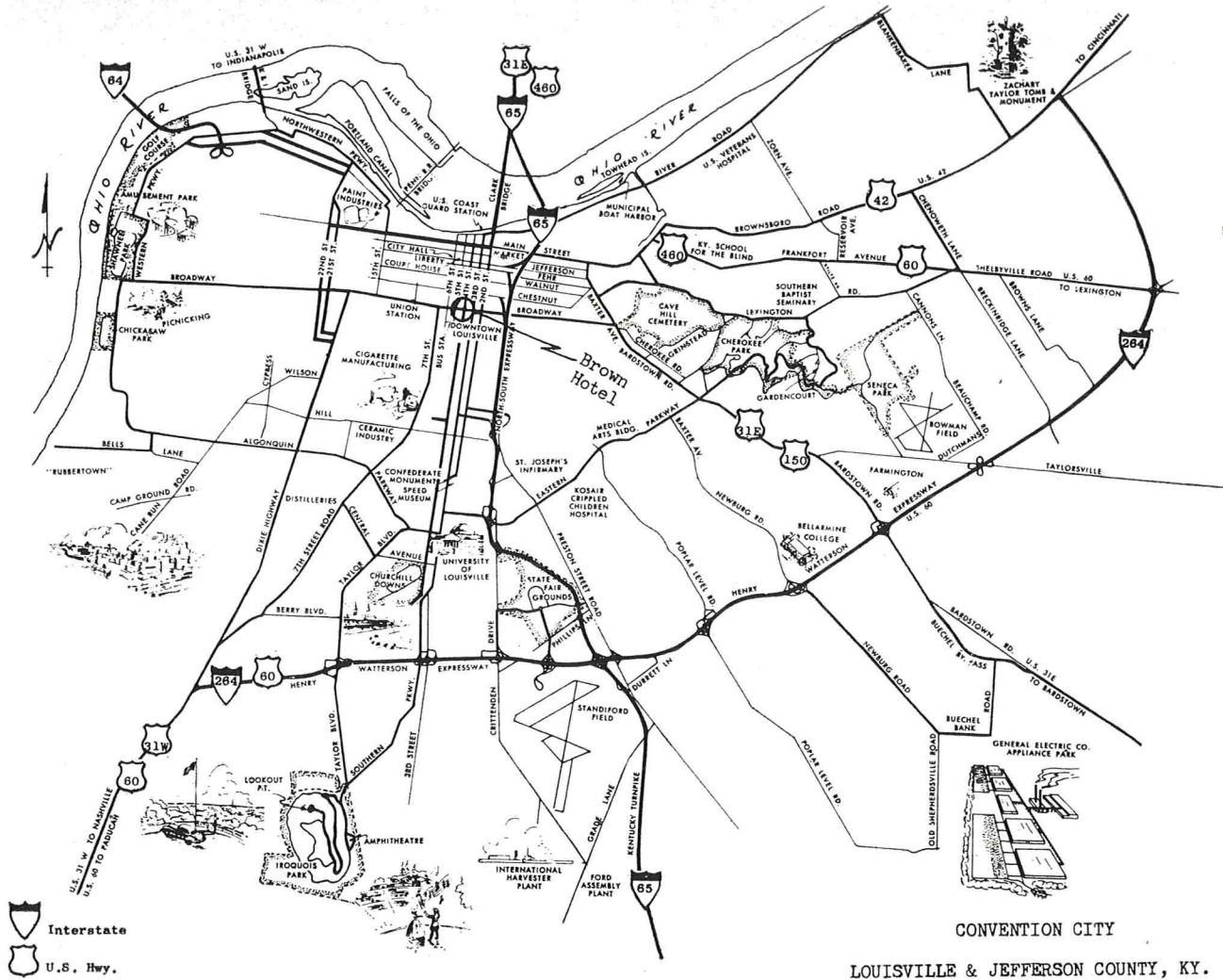

REVISED
1966
EDITION

Procedure for The Investigation of Foodborne Disease Outbreaks

REVISED
1966
EDITION

Recommended by
**INTERNATIONAL ASSOCIATION OF MILK, FOOD AND
ENVIRONMENTAL SANITARIANS, INC.**

COPIES OBTAINABLE FROM
International Association of Milk, Food and Environmental Sanitarians, Inc.
Box 437, Shelbyville, Indiana

Prices: Single Copies, \$1.00 each: 100 or more copies, 65 cents each.
25-100 copies, 75 cents each. Please do not send stamps.

OFFICERS AND EXECUTIVE BOARD

President, SAMUEL O. NOLES, Dairy Division, Florida State Board of Health, Jacksonville, Florida 32201.

President-Elect, MILTON E. HELD, 910 Lupin Way, San Carlos, Calif. 94070.

First Vice-President, DICK B. WHITEHEAD, 212 West Monroe St., Chicago, Ill. 60606.

Second Vice-President, ORLOWE M. OSTEN, Minn. Dept. of Agric., 517 State Office Bldg., St. Paul, Minn. 55101.

Secretary-Treasurer, ROY FAIRBANKS, 21 Salmon Court, Springfield, Ill. 62704.

Junior Past-President, A. N. MYHR, University of Guelph, Guelph, Ontario, Canada.

Senior Past-President, PAUL R. ELLIKER, Dept. Microbiology, Oregon State University, Corvallis, Oregon 97331.

Publication Board

DR. ELMER H. MARTH

H. L. THOMASSON, ROY FAIRBANKS

Editors

DR. ELMER H. MARTH, *Editor*, Dept. of Food Science, University of Wisconsin, Madison, Wis. 53706.

H. L. THOMASSON, *Executive Secretary and Managing Editor*, Box 437, Shelbyville, Indiana 46176.

Editorial Board

- C. A. ABELE -----Chicago, Illinois
- H. S. ADAMS -----Indianapolis, Indiana
- F. W. BARBER -----Glenview, Illinois
- J. C. FLAKE -----Washington, D. C.
- L. C. HARMON -----East Lansing, Mich.
- E. K. HARRIS -----Bethesda, Md.
- R. P. HAYWARD -----Bowie, Md.
- C. K. JOHNS -----Ottawa, Ontario, Canada
- O. W. KAUFFMANN -----Cincinnati, Ohio
- HERMAN KOREN -----Terre Haute, Ind.
- W. C. LAWTON -----St. Paul, Minnesota
- W. S. MUELLER -----Amherst, Mass.
- J. C. OLSON, JR. -----Washington, D. C.
- G. W. REINBOLD -----Ames, Iowa
- W. E. SANDINE -----Corvallis, Oregon
- K. G. WECKEL -----Madison, Wisconsin
- J. C. WHITE -----Ithaca, New York
- E. A. ZOTTOLA -----St. Paul Minn.

The Journal of Milk and Food Technology is issued monthly beginning with the January number. Each volume comprises 12 numbers. Published by the International Association of Milk, Food and Environmental Sanitarians, Inc. with executive offices of the Association, Blue Ridge Rd., P. O. Box 437, Shelbyville, Ind.

Entered as second class matters at the Post Office at Shelbyville, Ind., March 1952, under the Act of March 3, 1879.

EDITORIAL OFFICES: Dr. Elmer H. Marth, Dept. of Food Science, University of Wisconsin, Madison, Wis. 53706. H. L. Thomasson, Managing Editor, P. O. Box 437, Shelbyville, Indiana 46176.

Manuscripts: Correspondence regarding manuscripts and other reading material should be addressed to Dr. Elmer H. Marth, Dept. of Food Science, University of Wisconsin, Madison, Wis. 53706.

"Instruction to Contributors" can be obtained from the editor for the use of contributors of papers.

Page Charge: Effective January 1, 1969 a charge of \$25.00 per printed page will be made for all research papers which are published. See Volume 31, issues 10, 11, or 12 for details.

Journal of

MILK and FOOD TECHNOLOGY

INCLUDING MILK AND FOOD SANITATION

Official Publication

International Association of Milk, Food and Environmental Sanitarians, Inc.

Reg. U. S. Pat. Off.

Vol. 32

May, 1969

No. 5

Microbiological Quality Control in the Food Industry
D. A. A. Mossel -----155

The Biggest Problem in Food Hygiene-People
F. Oris Blackwell -----172

Influence of 32 and 37 C Incubation Temperatures on Counts of Coliform Bacteria of Milk
D. L. Mallett, R. T. Marshall and J. E. Edmondson -----176

Alignment of Industry-Oriented Sanitation Program
Fred H. Vitale -----179

Some Recent Views on Reconstitutability and Keeping Quality of Milk Powder
Sat Parkash -----183

Amendment to 3-A Sanitary Standards for Multiple-Use Plastic Materials Used as Product Contact Surfaces for Dairy Equipment -----186

Amendment to 3-A Accepted Practices for the Sanitary Construction, Installation, Testing and Operation of High-Temperature Short-Time Pasteurizers, Revised (Effective January 22, 1967) -----187

Association Affairs -----193

Report of the Committee on Applied Laboratory Methods 1967-1968 -----194

News and Events -----196

Index to Advertisers -----IV

Business Matters: Correspondence regarding business matters, advertising, subscriptions, orders for single copies, etc., should be addressed to H. L. Thomasson (address above).

Subscription Rates: One volume per year. Individual non-members, Governmental and Commercial Organization subscription.

- 1 yr. -----\$10.00
- Public and Educational Institution Libraries, 1 yr. -----\$ 8.00
- Single Copies -----\$ 1.00

Orders for Reprints: All orders for reprints

should be sent to the executive office of the Association, P. O. Box 437, Shelbyville, Ind.

Membership Dues: Membership in the International Association of Milk, Food and Environmental Sanitarians, Inc., is \$10.00 per year, which includes annual subscription to the *Journal of Milk and Food Technology*. All Correspondence regarding membership, remittances for dues, failure to receive copies of the *Journal*, changes in address and other such matters should be addressed to the Executive Secretary of the Association, H. L. Thomasson, Box 437, Shelbyville, Indiana 46176.

NOTICE

Attractive Membership Lapel Button Combination Tie Tac and Lapel Pin and Decals

NOW AVAILABLE

Convolution — Blue Circle & Bar Field — Blue
Letter "S" — White Lettering — Blue



ACTUAL SIZE

No. 3 1/4" Decals @ 25c each = \$.....

No. Lapel Buttons @ \$1.00 each = \$.....

No. Combination Tie Tac &
Lapel Pin — \$2.50 = \$.....

**International Association of
Milk, Food and Environmental
Sanitarians, Inc.**

Box 437, Shelbyville, Indiana 46176

CLASSIFIED ADS

FOR SALE

Single Service milk sample tubes. For further information and a catalogue please write, Dairy Technology Inc., P.O. Box 101, Eugene, Oregon 97401.

INDEX TO ADVERTISERS

Babson Bros., Co.	Back Cover
Fiske Associates, Inc.	Inside Back Cover
IAMFES, Inc.	I, II, IV, VI
Z. D. Roundy	IV
The Haynes Mfg. Co.	Inside Front Cover
Walker Stainless Equipment Co., Inc.	V

WISCONSIN MASTITIS TEST

*Reads directly in somatic cells per ml of milk.

*Rapid

*Simple

*Accurate

WMT standardized reagents (concentrate or ready-to-use), plastic test tubes (plain or calibrated to read directly in somatic cells per ml of milk), calibrated metal caps, nozzle gauges, measuring squares (calibrated to read directly in somatic cells per ml of milk or millimeter squares for reading in WMT values), racks and field kits.

Z. D. ROUNDY

5130 Pepin Place, Madison, Wisconsin 53705

DISTRIBUTOR

MICROBIOLOGICAL QUALITY CONTROL IN THE FOOD INDUSTRY¹

D. A. A. MOSSEL

Laboratory of Bacteriology
Central Institute for Nutrition and Food Research TNO,
Zeist, The Netherlands

(Received for publication June 27, 1968)

ABSTRACT

In quality control in the food industry in North-Western Europe, safety and keeping quality of final products are mostly maintained by preventative systems of factory surveillance, rather than by the "analytical" approach in which finished product samples are examined and measures taken later, based on the results of such an examination of samples. Methods are recommended for verifying that all preventative measures have been taken correctly.

Since microbiological examination of samples is often the sole way of checking on goods, e.g. upon importation, methods for this purpose are also recommended. It is strongly suggested that numbers of tests applied to each commodity are limited and that the groups of organisms to be determined in each instance will be chosen after careful study of the microorganisms associated with a particular food. The need for standards in evaluating the results obtained is stressed. A first attempt in streamlining, mechanization, automation, and data handling in this area, is presented.

Thorough retrospective complaint examination, i.e. a careful analysis of what may have caused rejection of consignments despite preventative quality control, is recommended as useful for avoiding repetition of the same or similar phenomena in future. Microbiological methods and chemical tests for microbial metabolites in instances where complete or partial autosterilization has occurred, are recommended.

PRINCIPLES

The purposes of microbiological quality control, whether carried out by government inspection services or industry, are mainly twofold: prevention of food-borne disease and retardation of microbial spoilage. In addition quality control must also meet general microbiological quality requirements, having no direct relationship to health or spoilage, e.g. microscopic counts of molds in canned tomato products or the enumeration of viable spores of the genus *Bacillus* in cocoa powder.

It is now generally accepted that microbiological quality control by the industry itself should be primarily of a preventative nature (158). This is much more effective than the analytical approach, i.e. inspection of the microbiological condition of the food as it leaves the factory, and subsequently taking cor-

rective measures if necessary. Authorities and buyers have also come to understand that, for statistical reasons (133), factory inspection is more effective, for their purposes too, than examination of finished samples.

Preventative microbiological quality control entails, in essence, the drafting and supervision of measures required to keep microbial counts low by reducing numbers of microorganisms contaminating the food and preventing proliferation of those microorganisms inevitably present. In this connection the following phases of contamination of, and proliferation in, foods have to be distinguished: (a) primary = microbial load of the raw materials; (b) secondary = increase in counts during processing; (c) tertiary = post-processing recontamination; (d) quaternary = contamination and/or growth during culinary preparation of the manufactured commodity.

Such control should be attained by the following measures: (a) procurement of raw materials of the best possible microbiological quality; (b) prevention of contamination of raw materials prior to processing; (c) proper processing, of whatever kind applied; (d) prevention of contamination of materials during and particularly after processing; (e) proper packaging; and (f) adequate storage, transportation, and handling of the finished product to consumption.

Obviously in this respect not all microorganisms have the same significance. Specific enteropathogenic and enterotoxinogenic bacteria, viruses, and particular helminths have to be controlled for the safety of consumers. In addition growth of molds in foods has to be kept under control since many types of fungi have been found recently to be mycotoxinogenic; cf. Table 1.

A great variety of bacteria, yeasts, and molds are typical spoilage agents for a given type of food; *vide infra*. Hence, in addition to the general precautions just outlined, special measures are often necessary to control occurrence or growth of particular microorganisms in foods (8).

SUPERVISION AND LABORATORY EXAMINATION OF THE FACTORY

Microbiological quality control, in this context, in-

¹Based on a series of lectures presented to the Summer Session Course 20.53 S, Department of Nutrition and Food Science, Massachusetts Institute of Technology, Cambridge, Mass., June 20-21, 1968.

TABLE 1. MYCOTOXINOGENIC MOLDS¹

Species	Clinical effect	Susceptible species
<i>Group 1, Producers of well-defined mycotoxins</i>		
<i>Alternaria tenuis</i>	ATA	man
<i>Alternaria</i> sp.	haemorrhages	mouse
<i>Aspergillus amstelodami</i>	emaciation	poultry
<i>A. candidus</i>	cf. <i>P. citrinum</i>	
<i>A. clavatus</i>	haemorrhages	poultry
<i>A. flavus</i>	hepatic carcinoma	poultry, man
	tremors	mouse
	haemorrhages	swine
<i>A. fumigatus</i>	perirenal oedema	swine
<i>A. glaucus</i>	haemorrhages & diarrhoea	poultry
<i>A. niger</i>	cf. <i>A. flavus</i>	
<i>A. ochraceus</i>	hepatic injury	poultry
		rat
<i>A. oryzae</i>	hepatic necrosis	various
<i>A. ostianus</i>	cf. <i>A. ochraceus</i>	
<i>A. parasiticus</i>	cf. <i>A. flavus</i>	
<i>A. ruber</i>	cf. <i>A. flavus</i>	
<i>A. terreus</i>	cf. <i>P. citrinum</i>	
<i>A. wentii</i>	emaciation	poultry
<i>Chaetomium globosum</i>	haemorrhages & paralysis	rat
<i>Cladosporium epiphyllum</i>	ATA	man
<i>Fusarium culmorum</i>	anorexia	bovine
<i>Fusarium nivale</i>	emaciation & gangrene	bovine
<i>F. roseum</i> (Syn. <i>Gibberella saubinetii</i>)	hepatic necrosis	swine
<i>F. sporotrichioides</i>	ATA	man
<i>Gibberella zeae</i>	oestromimetic response	swine
<i>Mucor hiemalis</i>	ATA	man
<i>Penicillium brevicompactum</i>	ATA	man
<i>P. citreoviride</i>	ascending paralyzes	various
<i>P. citrinum</i>	haemorrhages & renal damage	poultry
	tremors	mouse
<i>P. cyclopium</i>	hepatic atrophia & cirrhosis	mouse
<i>P. islandicum</i>		various
<i>P. puberulum</i>	cf. <i>A. flavus</i>	
<i>P. rubrum</i>	haemorrhages & hepatic injury	swine
<i>P. rugulosum</i>	cf. <i>P. citrinum</i>	
<i>P. tardum</i>	cf. <i>P. citrinum</i>	
<i>P. variabile</i>	cf. <i>A. flavus</i>	
<i>P. viridicatum</i>	renal damage	swine, rat
<i>P.</i> species	cf. <i>A. ochraceus</i>	
<i>Pithomyces chartarum</i>	angiocholecystitis	sheep
	facial oedema	bovine
<i>Rhizopus</i> sp.	cf. <i>A. flavus</i>	
<i>Stachybotrys atra</i>	haemorrhages	horse

Group 2, Producers of less well-defined orally active toxins

Aspergillus avenaceus, carneus, chevalieri, nidulans & *niveus*
Cladosporium fragi
Fusarium moniliforme
Paecilomyces varioti (Syn. *Byssoschlamys fulva*)
Penicillium oxalicum, piceum, purpurogenum, urticae
Trichoderma lignorum

¹Data compiled from references 13, 19, 26, 27, 28, 29, 32, 44, 48, 51, 56, 60, 61, 72, 73, 76, 77, 78, 114, 117, 121, 127, 134, 138, 142, 144, 145, 149, 153, 154, 155, 156, 157, 160.

volves, first of all, frequent checks on proper processing and handling of goods throughout the plant. An important example of factory quality control is found in the heat processing of foods, the most frequently used mode of decontamination as well as preservation. In this connection, it should be realized that the net microbicidal effect of a heat treatment depends strongly on (a) the time-temperature combination applied; (b) the pH and water activity (a) of the food treated; and (c) the efficacy of measures taken to avoid postprocess recontamination. Each of these factors has to be controlled within narrow limits if heat processing is to be effective (63).

Also, regular examinations have to be carried out of the food processing machinery. This has to be dismantled and decontaminated when required by the bacteriological data obtained. Otherwise considerable build-up of often highly resistant and tenacious organisms may occur as a result of continuous culture (1, 16, 47, 113). In addition, periodical checks are to be made of premises, cleanliness of the staff, packaging materials, and the water supply. The pressing need for adequate surveillance of the air supply has been demonstrated repeatedly (16, 63, 91, 126). Finally the evaluation of any disinfectants and detergent sanitizers used forms an important part of the task of the laboratory (64, 89).

Table 2 reviews the methods which have been found useful in the author's Institute during the last 15 years. The types of organisms for which one seeks, obviously, depend greatly on whether one is interested in those that may spoil a given food, or in organisms that might render the food unsafe for consumption — that is, lead to food-borne disease eventually if not immediately. However, whatever types may be of interest, one is always concerned with their numbers per unit of surface area or weight. Qualitative results, often formulated simply on the basis of the absence or presence of a certain organism on "the" machinery or in "the" air supply, etc. are usually of lesser value, unless formulated in a semi-quantitative way, i.e. absence of the organism in a well specified quantity or surface area.

TABLE 2. VERIFICATION METHODS USED IN MICROBIOLOGICAL PLANT CONTROL

Parameter to be verified	Recommended instrument or method	Reference
Time-temperature integrals	thermograph; indicator strips; tests for residual enzyme activity	Stumbo (136) Ingram & Roberts (49) Ganter & Körmendy (30) Musa & Schnable (104)
Relative humidity or a_w	polyelectrolyte resistance humidity elements	
Decontamination efficiency of foods, processed for safety	spec. count of nat. or artific. (a) $\frac{\text{contam. sample}}{\text{same count of treated sample}}$ (b) $\frac{\text{count of spores of } Bacillus}{\text{total bacterial count}}$	Mossel, van Schothorst & Kampelmacher (96) Mossel (95)
Surface decontamination efficiency of food, processing apparatus	(a) swabs (b) impression plates, agar slices, tapes or pads	Higgins (41); Thomas (143); ten Cate (10); Holt (45); Mos- sel, Kampelmacher & van Noorle Jansen (94)
Microbiological condition of water supply	(a) total count of mesophilic and psychrotrophic bacteria (b) MPN enumeration of <i>Enterobacteriaceae</i> and <i>E. coli</i>	Mossel (95)
Microbiological condition of air supply	(a) slit sampler technique (b) absorption in an impinger or moistened plugs of calcium alginate (c) sedimentation plates, Mossel (91)	Bourdillon et al. (6) May (70); Richards (118); Mos- sel (91)
Sanitary condition of hands	five-finger impression counts on ETGPA ¹ and VRBG ²	de Vries & Knappe (148)
Body cleanliness	VRBG, ETGPA and blood agar impression plates of predilection sites	Sarkany & Gaylarde (124); Mos- sel et al. (99)
Effectiveness of disinfectants and detergent sanitizers	(a) Strains: <i>S. aureus</i> , <i>S. typhimurium</i> , <i>P. aeruginosa</i> , <i>S. faecalis</i> , spores of <i>B. cereus</i> , <i>S. cerevisiae</i> (b) Exposition: 5 min at c. 15 C (c) Neutralisation: Tween-blood-thiosulphate broth (d) Requirement: 5 D, except sometimes for spores	Mossel (89)

¹Egg yolk tellurite glycine pyruvate agar

²Violet red bile glucose agar (88)

MICROBIOLOGICAL QUALITY CONTROL OF RAW MATERIALS

It should be stressed that it may not always be easy to procure raw materials of satisfactory bacteriological quality. This is particularly true of red meats and poultry. To obtain carcasses with a tolerable degree of *Salmonella* contamination, the meat and poultry industry has had to begin to extend control measures to the farms. This includes provision of pathogen-free young animals, bacteriological control of feed, and considerable improvement of the sanitary conditions of the animals on the farm, during transportation, and while awaiting slaughter (21, 31, 40, 106, 125). Pending these developments, initially rather tolerant specifications will have to be used, but these will gradually have to be made stricter, applying the "sliding scale" principle (35).

Even where such vast problems do not exist, the drafting of microbiological specifications for raw materials should be done very carefully and particularly with proper reference to ecological principles. This involves taking the following aspects into account: (a) the significant organisms amongst the microflora of the raw materials under study; (b) the numbers of each of these that can be allowed in the final products; (c) the desired safety margins as determined by the processing to be applied in the course of manufacture; and (d) attainability of the specifications. With respect to the latter point, considerable collaboration is often required before suppliers can consistently meet purchasers' specifications, although this is, very fortunately, not always as difficult as with carcass meats or poultry.

The microflora of minor components, e.g. spices,

may also impair the microbiological quality of manufactured foods. As to requirements for such materials, their microflora should not essentially influence the load of organisms which determine wholesomeness and/or keeping quality, that are encountered in the major component of the food. Hence, requirements for minor ingredients can be more lenient, the lower their concentration is in the final product (80).

MICROBIOLOGICAL EXAMINATION OF THE FINAL PRODUCT

Careful implementation of microbiological quality control at the production level, on the above basis, will usually assure adequate keeping quality and wholesomeness. In addition, one might wish to assess the microbiological condition of the food itself. Such final product analysis hence is of interest to the processor; however, to the public health official of the country importing the food products, and to the bacteriologist working on behalf of the buyers, it is often the only information available. In other words, microbiological examination of end product samples makes sense but only as a mode of *assessing* proper production, not as a means of *attaining* the required microbiological quality.

Wholesomeness

Pathogens. Various groups are relevant to the determination of the wholesomeness of foods (43). A review of these organisms and recommended methods for their enumeration are presented in Table 3. Those currently of major interest from the standpoint of outbreaks of food-borne diseases are: *Salmonella*, *Staphylococcus aureus*, and *Clostridium perfringens* (147) and to a lesser extent *Bacillus cereus* (107) and *Vibrio parahaemolyticus* (162). Also, as indicated before, quantitative examinations for molds should be made regularly, since so many types of fungi, according to Table 1, form orally active mycotoxins and can, therefore, not be tolerated in foods. Either viable mold spores or microscopically visible mycelia and spores have to be determined, depending on whether the majority of the molds is still viable or already dead. Suitable methods for this purpose will be recommended in the following sections.

A short remark may be in order here with regard to the use of so-called selective media in general and in microbiological quality control in the food industry in particular. Formulation, preparation, sterilization and inoculation of such media should be most carefully standardized. Selectivity and productivity of selective media depends entirely on the active concentration of one or more added inhibitory compounds. The latter is determined by (a) concen-

tration of inhibitor added to the medium; (b) degree of inactivation during sterilization of the medium; and (c) extent of neutralization by one or more components of the food sample examined. If such details are not properly taken into account, quite unreliable and irreproducible results — leading amongst others to a complete lack of agreement between laboratories of buyers and sellers, or food processors and public health authorities — must be anticipated (116).

Moreover, selective media should always be tested for their capacity to also recover impaired cells of the types sought. Bacterial cells that have been stressed by sublethal heating, exposure to reduced a_w or low pH, etc., will usually not tolerate concentrations of selective agents that are generally acceptable in media, since they are without significant inhibitory effect on non-stressed cells of the same group, genus, or species. We have confirmed many earlier observations on such an effect in impaired cells of *Enterobacteriaceae* with regard to triphenyl methane dyes and, to a lesser extent, bile salts (101). Along the same line we have observed that stressed populations of Lancefield group D streptococci do not tolerate concentrations of methylene blue and slightly increased pH values, that are exempt of any inhibitory effect on non-impaired populations of the same group of bacteria. Erroneously low results in the examination of heated, dried, or acid foods, as a result of missing such stressed cells resulting from direct use of many selective media, have to be anticipated. Such errors have to be avoided by previous so-called resuscitation of impaired populations. In this step dilutions of the food wherein such cells occur are cultured on rich, non-selective solid media. Subsequently colonies of the restored cells thus obtained are replicated onto the usual selective media. Obviously similar preliminary resuscitation steps in liquid media must be applied when MPN-counts, or presence or absence tests, are carried out using selective liquid media.

Indicator organisms. It is, in addition, often useful to enumerate so-called indicator organisms — bacteria indicating objectionable bacteriological condition of foods. The conventionally sought proof of the absence of pathogens in a representative sample of food has significance only for the consignment under investigation; however, the repeated failure to find suitably chosen types of indicator organisms in successive samples makes it unlikely that foods manufactured in the same way will ever be dangerously contaminated. This is valuable information for the trade, food inspection services, and the consumer (95, 163).

The use of indicator organisms has often been criticized (71), and not always without reason (95).

However, provided that proper ecological consideration is given to the significance of given numbers of particular organisms in a specific food, no criticism is justified against this most valuable analytical parameter. The use of *Enterobacteriaceae* as indicator organisms may be given as an example.

When foods are processed with heat to such an extent that the lethal effect on non-spore bearing bacteria is somewhere between 4 and 7 decimal reductions, the presence of *Enterobacteriaceae* in numbers over 1 to 10 per g cannot be accepted. The reason is that this would indicate that processing has not been completed or that an adequate decontamination treatment has been carried out, but it has been followed by post-process recontamination. Either of these conditions is highly undesirable, because it may have resulted in, or will result in the future in, the presence of enteric or other pathogens in such foods. However, for fresh foods or commodities that have only been processed at temperatures well below 50 C, where virtually no bactericidal effect can be expected, the situation is entirely different. Because the natural flora of such foods is known to include *Enterobacteriaceae*, the mere "presence" of these bacteria in such products is no reason for their rejection. Rather, one is interested, in this instance, in knowing more exactly what types of *Enterobacteriaceae* occur, since it makes a noteworthy difference whether *Serratia* or *Enterobacter* of vegetable origin are present, or *Escherichia coli* which might indicate a more dangerous contamination. For this purpose we have developed the differential enterobacteriogram, in which the types of *Enterobacteriaceae* are determined in addition to their numbers (101). There is a valid reason to reject a sample of this class only if one or more of the following deficiencies are encountered: (a) occurrence of pathogenic species of *Enterobacteriaceae* in aliquots of 10-20/g; (b) the presence of *E. coli* in an approximately 0.1 g sample; (c) the occurrence of viable *Enterobacteriaceae* at a level that exceeds the numbers encountered in commodities produced under sanitary manufacturing conditions (95).

Enzyme tests. Reliance is often placed on the absence of the enzymatic activity of, for example, phosphatase or amylase in heat processed products as an index of proper manufacturing (30, 33, 49, 71). No doubt, a negative result of such enzyme tests indicates that the commodities under examination have been sufficiently heat-treated to eliminate the pathogenic organisms originally present. However, enzyme tests are not sensitive enough to indicate the absence of recontamination; and this is the most frequent source of failure of pasteurization treatments (15, 50, 53, 161). Hence, the sole use of these enzyme tests seems to lead to a false sense of security (7).

However, the use of a combination of an enzyme test with an examination for, e.g. *Enterobacteriaceae*, is very profitable, since it will provide differentiation between inadequate pasteurization and post-pasteurization contamination. The food microbiologist, expected to advise on improvements in processing can then decide, guided by the two tests, whether the heat-treatment or rather the sanitation of the post-pasteurization stages needs closer attention (95).

Because of their very high radiation resistance, none of those enzymes has been found to be inactivated by doses of radiation used in radiation pasteurization ("radication"). This makes enzyme tests unsuitable for the control of radication treatments (49), whereas tests for indicator organisms maintain their validity here (96).

Total counts. It may sometimes be of interest to determine the total numbers of viable aerobic and facultatively anaerobic mesophilic microorganisms per 1 g of food. The latter parameters are often called "total counts." They will show to what extent microbial contamination, but more particularly proliferation, in general has occurred. However, in studying food wholesomeness, the enumeration of the specific pathogenic or toxinogenic bacteria or suitably chosen indicator organisms has a higher priority.

Keeping quality

Direct determination of stability of shelf-stable items. Shelf life tests carried out for this purpose should be designed carefully.

Firstly, the number of samples and the degree of randomization with which these are to be taken should be determined accurately. Too small a number of samples, or inadequate randomization may lead to a false feeling of security with regard to the keeping quality of the final product, whereas too high a degree of sampling may lead to exceeding the capacity of the laboratory. A proper mathematically justified approach to optimal sampling is therefore always required (133).

With regard to the choice of the storage temperature, it is necessary to use in shelf life tests a cyclic system of incubation. The reasons for this are that: (a) changing temperatures will also occur in practice; and (b) water vapor migration effects often limit the shelf life of packaged products (100), and such effects are potentiated by the use of temperature changes during incubation. It is, therefore, our practice to incubate samples of shelf-stable foods at 25 ± 1 C during the day time and at 15 ± 1 C overnight.

The next point is the choice of criteria of spoilage. In order to obtain fast preliminary results, it can often be recommended that counts of significant types of spoilage organisms (*vide infra*) are carried

TABLE 3. REVIEW OF RECOMMENDED METHODS FOR THE MICROBIOLOGICAL EXAMINATION OF FOODS WITH PARTICULAR REFERENCE TO PUBLIC HEALTH ASPECTS

Group of organisms sought	Presumptive counting procedure	Confirmation	Completion or identification	
<i>Salmonella</i> and <i>Arizona</i>	MPN-enrichment procedure with at least 20 g aliquots using: (a) for general purposes: Muller (103)-Kauffmann's (55) tetrathionate broth at 43 C (Harvey & Thomson, 38; Read & Reyes, 115; Harvey & Price, 39); (b) if resuscitation is required: use of Hobbs' (42) nutrient broth or North's (109) lactose broth incubated at 30 C, followed by (a) above (Mossel & Vincentie, 101). When counts >10/g might occur: enumeration in sulphite iron agar (Mossel, 83) contained in plastic pouches (Bladel & Greenberg, 5; de Waart & Smit, 150)	Plating of 0.1 ml of 10 ⁵ dilutions, simultaneously on 15 cm dia-plates of (a) special brilliant green phenol red agar (Kampelmacher, 54); (b) deoxycholate citrate agar; (c) bismuth sulphite agar, aged according to Cook (17) eg → BPA ²	Subsequently: (a) Kl eg → β Gal. eg → P eg → UDKAM-al; (b) agglutinations; (c) phage test (Buttiaux et al., 9; Ewing et al., 22; Le Minor & Ben Hamida, 62; Ewing & Fife, 23)	
<i>Shigella</i>	Plating of at least 100 mg on SS-agar and Taylor's (140, 141) XLD agar in 15 cm dia-plates and incubation at 37 C		completion tests as for <i>Salmonella</i> + Mo	
<i>Enterobacteriaceae</i>	(a) When counts >10/g are expected: Plating in Mac Conkey ('Violet Red bile') glucose agar (Mossel et al., 88) incubated 20 hr at 37 C, unless resuscitation is required- <i>vide supra</i> (b) When counts <10/g are expected: MPN-enrichment procedure with 0.1, 1 and 10 g, using buffered brilliant green bile glucose (EE) broth, at 30 C, unless resuscitation is required- <i>vide supra</i>	OxGNi	→ Lac. + → C → E McC → Lac. O → β Gal. → P → >UDKAMal OxGNi → McC → <i>vide supra</i>	
<i>E. coli</i>	MPN-enrichment procedure with 0.1, 1 and 10 g, using brilliant green bile (BGB) broth at 44 C, unless resuscitation is required- <i>vide supra</i>	<i>Either</i> : plating on Mac Conkey ('Violet Red bile') glucose agar (VRBG) <i>Or</i> : DEG = plating onto VRBG, Chapman's (12) tergitol/TTC/agar at 44 C XLD and BPA ² (Mossel & Vincentie, 101) E = gas formation in BGB and production of indole at 44 C		IMVC—but hardly necessary
<i>S. aureus</i>	(a) When counts >10 ² /g are expected: Plating on Baird Parker's (2) ETGP agar incubated for 30 hr at 37 C. (b) When counts <10 ² /g are expected: MPN-enrichment procedure with 0.1, 1 and 10 g, using Giolitti & Cantoni's (34) anaerobic tellurite glycine mannitol pyruvate broth, incubated at 37 C.	Adequate numbers of typical egg yolk positive as well as typical, but egg yolk negative (de Waart et al., 151; Hall, 37) colonies: Co Plating on ETGP agar, etc. . . <i>vide supra</i>		Phage typing Co, phage typing
Lancefield group D streptococci	Plating in Packer's (112) crystal violet sodium azide blood agar ¹ , incubated at 37 C	TMiAzLCA		Sherman characters, especially BiT, So
<i>S. mitis</i> and <i>S. salivarius</i>	Plating on Chapman's (11) TCTS-agar, incubated at 37 C	TAzBiT → AesArGLevRaSo (Cowan & Steel, 18)		
<i>Clostridium</i> sp.	Counts, in glucose free 0.05% sulphite iron polymyxin agar (83) contained in Miller-Prickett tubes or plastic pouches, at 32 C	AnCaSu		MiMoNiIGSaLacGelLec (anaer.)
<i>C. botulinum</i>	MPN-enrichment procedure in sulphite iron polymyxin broth (Mossel & de Waart, 102)	Alcohol treatment (Johnston et al., 52) → plating on BYCA		MoNiClSal (Anaer.) → mouse test, FA
<i>C. perfringens</i>	Counts in Marshall et al.'s (68) TSN-agar at 46 C.	Plating on LENA at 46 C		Mo
<i>B. cereus</i>	Plating on Mossel, Koopman & Jongerius' (98) MYP-agar incubated at 32 C	MiGXyAnNiGelVLec		—
<i>Vibrio parahaemolyticus</i>	MPN-enrichment procedure in infusion broth with 2% NaCl and 5 ug/ml tylosin at 37 C	Plating on 2% NaCl saccharose tee-pol bromo thymol blue tylosin agar of pH = 9.2, incubated at 37 C		K10xNiMoStH

¹Where blood is not available, the recommended medium is azide dextrose kanamycin agar (ADKA)²For the detection of *Arizona* streaking onto brilliant green phenol red sucrose agar (heated for no more than 30 min at 100 C) is recommended and subsequently the series of biochemical tests KIUDKMAlDu

TABLE 4. SPOILAGE ASSOCIATION OF THE MOST IMPORTANT CLASSES OF STAPLE FOODS OF GOOD QUALITY

Class	pH	a w	Processing with microbicidal effect	Examples of commodities	Association							
					Gram neg. rods Non-ferm. ¹	Ferm.	Catalase pos. cocci	Catalase neg. cocci	<i>Lacto- bacil- laceae</i>	<i>Bacil- laceae</i>	Molds	Yeasts
1	>4.5	>0.95	None	Fresh meats, fish, shell fish, poultry, eggs & egg products	+++	+	+	±	0	0	+	0
2	>4.5	>0.95	None	Vegetables	+++	±	0	±	+	+	+	0
3	>4.5	<0.90	None	Cereal grains, pulses	+	+	+	0	+	+	+++	+
4A	<4.5	>0.95	None	Fruits	0	±	0	0	++	0	++	+
B	<4.5	>0.95	None	Juices	+ ²	±	0	++	++	0	±	++
5	>4.5	>0.95	Pasteurisation	Liquid milk	±	±	±	+	+	+	0	0
6	>4.5	c.0.95	Cooking	Cooked sausage, canned large size hams	0	0	±	+	+	+	0	0
7	>4.5	c.0.95	Baking	Bread, rolls, cakes	0	0	0	0	0	+	++	±
8A	>4.5	<0.90	None	Dried vegetables, cereals & cocoa;	0	0	0	0	0	0	++	0
B	>4.5			Marzipan, chocolate fillings	0	0	0	0	±	0	+	++
C	<4.5			Dried fruits	0	0	0	0	±	0	++	++
9	c.4.5	c.0.96	None	Butter and margarine	0	0	±	±	0	0	+	+
10A	>4.5	>0.95	Appertisation	Meats, vegetables and milk packed in hermetically sealed containers	0	0	0	0	0	++	0	0
B	<4.5	>0.95	Appertisation	Fruits and juices packed in hermetically sealed containers	0	0	0	0	0	++	+	0

Frequency scale used: +++ = virtually exclusive and at all times ++ = dominant + = significant ± = minor or occasional 0 = virtually of no importance in spoilage

¹The *Pseudomonas/Acinetobacter/Achromobacter*-group, unless otherwise indicated

²*Acetobacter*

TABLE 5A. LEGEND TO TABLES 3 AND 5

A	= agglutination with <i>Salmonella</i> polyvalent anti O-serum	M	= methyl red test
ADKA	= azide dextrose kanamycin agar	Ma	= dissimilation of mannitol (cf. G)
Aes	= dissimilation of aesculin	Mal	= assimilation of malonate
An	= growth under anaerobic conditions	Malt	= dissimilation of maltose (cf. G)
Ar	= dissimilation of arabinose (cf. G)	McC	= crystal violet neutral red bile lactose agar (MacConkey, 66)
Az	= azide tolerance	Mi	= microscopic examination
β Gal.	= β galactosidase reaction	Mo	= motility test in U-tubes
BGB	= brilliant green bile broth	MP	= mannitol peptone agar (Sellers, 128)
BHIS	= brain heart infusion broth with 0.1% soluble starch	MPN	= most probable number
BiT	= growth in 40% bile broth	MYP	= mannitol egg yolk polymyxin agar (Mossel, Koopman & Jongerius, 98)
BPA	= brilliant green phenol red lactose sucrose agar	Ni	= nitrate reduction
BYCA	= brain heart infusion egg yolk cystein agar	Ox	= oxidase activity (Kovacs' (59) method)
C	= assimilation of citrate (Simmons' (130) method)	P	= phenyl alanin desaminase (Buttiaux et al.'s (9) method)
Ca	= catalase activity	Ra	= dissimilation of raffinose (cf. G)
Cell	= dissimilation of cellobiose (cf. G)	Sa	= dissimilation of saccharose (cf. G)
Co	= coagulase activity	Sal	= dissimilation of salicin (cf. G)
D	= lysine decarboxylase activity (Taylor's (139) method)	So	= dissimilation of sorbitol (cf. G)
Du	= dissimilation of dulcitol (cf. G)	SS	= <i>Salmonella Shigella</i> agar
E	= Eijkman's (25) thermotolerance test, in the modification of MacKenzie et al. (67); cf. Guinee & Mossel (36)	STAn	= soytone trypticase yeast extract cystein agar (Mossel et al., 93)
EE	= <i>Enterobacteriaceae</i> enrichment broth (Mossel, Visser & Cornelissen, 90)	St	= dissimilation of starch (cf. G)
ETGP	= egg yolk tellurite glycine pyruvate agar (Baird-Parker, 2)	Su	= sulfite reduction in 0.05% Na ₂ SO ₃ /FeSO ₄ -agar
FA	= fluorescent antibody stain technique	T	= growth at 45 \pm 0.1 C
G	= dissimilation of glucose, studied in stabbed, freshly steamed agar tubes (Mossel & Martin, 86)	TCTS	= trypan blue crystal violet tellurite sucrose agar (Chapman, 11)
Gel	= dissimilation of gelatin	TDYM	= tryptone dextrose yeast extract peptonized milk agar (Mossel & Krugers Dagneaux, 84)
Gl	= dissimilation* of glycerol (cf. G)	TSN	= tryptone sulfite polymyxin neomycin agar (Marshall et al., 68)
I	= formation of indole from tryptophan	U	= hydrolysis of urea (Christensen's (14) method)
K	= KCN-tolerance (Buttiaux et al.'s (9) method)	V	= Voges-Proskauer test for acetylmethylcarbinol
KECA	= kanamycin methylene blue azide agar of pH 8.0	VRBG	= violet red bile glucose agar (Mossel et al., 88)
KI	= behaviour in stabbed, freshly steamed tubes of Kligler (57) iron agar	XLD	= xylose lysine deoxycholate agar (Taylor & Harris, 140)
L	= tolerance of azide + ethyl violet, according to Litsky et al. (65)	Xy	= dissimilation of xylose (cf. G)
Lac	= dissimilation of lactose (cf. G)		
Lac 10	= oxidation of lactose on 10% lactose slants (135)		
Lec	= lecithinase activity		
LENA	= lactose egg yolk neomycin agar (Willis & Hobbs, 152)		
Lev	= formation of levan from sucrose		

out in fresh as well as in incubated samples, after the storage test has been in operation for say about a week. By comparing the counts of such organisms in incubated samples with the counts of the same organisms in fresh samples, or samples stored under refrigeration, a tentative impression of the growth of potentially dangerous organisms in the food under examination can be obtained. Quite often such an increase in counts indicates inadequate shelf life

CENTRAL INSTITUTE FOR NUTRITION AND FOOD RESEARCH TNO DEPARTMENT OF MICROBIOLOGY.						
DESCRIPTION OF FOOD SAMPLE EXAMINED				COLUMN NRS.	DATA PROCESSING PART	
DATE OF RECEIPT				01 - 06		
TYPE OF FOOD				07 - 08		
COMMODITY				09 - 35		
MANUFACTURER				36 - 40		
CRITERION USED IN EVALUATION		RESULT	SPECIFICATION	"WEIGHED" DEFICIENCY		
NR	DESCRIPTION					
01	TOTAL AEROBIC COUNT			41 - 43		
02	AEROBIC SPORE COUNT			44 - 46		
03	TOTAL ANAEROBIC COUNT			47 - 49		
04	GRAM-NEG ROD-SHAPED BACT.			50 - 52		
05	SALMONELLA / ARIZONA			53 - 55		
06	ENTEROBACTERIACEAE			56 - 58		
07	DIFFERENTIAL ENTEROBACTERIOGRAM			59 - 61		
08	CATALASE POS. COCCI			62 - 64		
09	STAPH. AUREUS			65 - 67		
10	LANCEFIELD D STREPTOCOCCI			68 - 70		
11	LACTOBACILLACEAE			71 - 73		
12	SULPHITE-REDUCING CLOSTR.			74 - 76		
13	CL. BOTULINUM			77 - 79		
14	CL. PERFRINGENS			80 - 82		
15	BAC. CEREUS			83 - 85		
16	MOULDSPORES			86 - 88		
17	YEASTS			89 - 91		
18				92 - 94		
19				95 - 97		
CONCLUSION				98		

CIVO-TNO G 2601

Figure 1. Front of card used to collect data on test samples.

very much earlier than organoleptic tests may do. Clearly, the greatest caution has to be exerted in interpreting the course of such counts; on no account should attention be paid to minimal increases in counts, until proper statistical treatment of the data obtained has confirmed these differences to be significant. It is our experience that a significant increase requires at least that counts have doubled and often, i.e. in more heterogeneous materials, even tripled.

In some instances the naturally occurring contamination of rather stable foods is too small or too erratic to serve as a reliable inoculum in such stability tests. Then artificial inoculation of the commodities under study has to be carried out. We have found the following mixed inoculum, at an initial density of approximately 10^2 cells/g of food quite useful: (a) spores of the mold flora of wheat bran; (b) the *Lactobacillus* flora of meat salads after storage for about one week at 10 C; (c) a pure culture of *Saccharomyces rouxii*. After suitable period of storage numbers

of these organisms are determined again, unless macroscopic signs of spoilage already indicate that proliferation of the inoculum has occurred.

Prediction of the keeping quality of perishable foods. In general the keeping quality of perishable foods is not assessed directly, but instead quantitative determinations are made of the organisms capable of spoiling the food under study — the so-called spoilage association. From such data the keeping quality can then be estimated (81).

This association depends (a) on the conditions of storage; and (b) on certain properties of the food, viz. those which determine whether or not a given organism will be able to proliferate in it. These properties are primarily the food's water activity and its pH; and the presence of antimicrobial compounds, either naturally occurring ones or those added during processing, such as salt, vinegar, smoke components, and synthetic preservatives. In Table 4 a review of the organisms which play a role in the microbial spoilage of particular foods is presented. In Table

5 the methods which have been found useful for their enumeration have been compiled.

Choice of tests

An important general aspect of final product examination is that the number of tests should be limited as much as possible. This will allow large numbers of samples to be examined, thereby satisfying statistical requirements (133). This also necessitates the use of methods of maximal simplicity and rapidity, which have been carefully standardized so that reliability will not suffer.

In this connection, again, the use of well chosen indicator organisms can be particularly valuable.

Instrumentation and automation

During the last decennium a rising load of examinations entrusted to the laboratory for food microbiology has been observed. This results from an apparently ever-increasing tendency to draft and apply microbiological specifications for food products, both by government agencies and by industry. It is ob-

vious that this increasing demand can only be met in the future if considerable streamlining in laboratory methods is achieved.

In attempting this we have so far refrained from using new instrumental methods of sensing of some sort. Rather we have applied the replication principle, suggested by Corlett et al. (17a). First of all, spread drop counts are made on two rich infusion agars (84, 93) which are then incubated aerobically and anaerobically, respectively. From the aerobic "master plate" a representative choice of colonies is subsequently transferred to the set of media, presented in Table 6. After suitable incubation these plates are read according to the key given in the third column of that table. If required, or in case of doubt, additional tests are carried out. These include: (a) microscopic examination using a Gram stain; (b) simple biochemical tests, such as catalase, oxidase, and coagulase reactions; (c) growth tests on a rich infusion medium at the cardinal temperatures: 43 C for salmonellae, 44 C for *E. coli*, 45 C for

INSTRUCTIONS FOR CODING		
COL. NRS.	CRITERION	HOW TO CODE
01-06	DATE OF RECEIPT	YEAR - MONTH - DAY
07-08	SHELF-STABLE OR OTHER	
09-35	COMMODITY	FREE
36-40	MANUFACTURER	FREE
41-97	ENUMERATIONS	1. $a \times 10^b \rightarrow boa$ 2. below limit $\rightarrow 999$
41-97	"WEIGHED" DEFICIENCIES	1. If found enumeration = N_f and specification = N_s , evaluate N_f/N_s in terms of $\geq 4, \geq 40, \geq 400$, etc. and attribute <u>one</u> deficiency to ≥ 4 , <u>two</u> to ≥ 40 , etc. 2. Do not use this method for presence or absence (PA) tests for Salmonella, Arizona, Shigella or Clostridium botulinum.
98	CONCLUSION	1. Add numbers of deficiencies found under 41-97 and evaluate as $< 1 =$ excellent; $1 =$ good; $2 =$ fair; $3 =$ slightly deficient; $4 =$ deficient; $5 =$ poor; $6 =$ very poor; $7 =$ extremely poor. 2. If PA for 41-97,2 is +ve, evaluate as: rejected

CIVO-TNO G 2602

Figure 2. Back of card used to collect data on test samples.

TABLE 5. REVIEW OF RECOMMENDED METHODS FOR THE MICROBIOLOGICAL EXAMINATION OF FOODS WITH PARTICULAR REFERENCE TO SPOILAGE ASPECTS

Group of organisms sought	Presumptive counting procedure	Confirmation	Completion or identification
Gram-negative, rod shaped bacteria	Plating on Olson's (111) 1 ppm Crystal Violet sugar-free (gelysate/trypticase; <i>vide infra</i>) and incubation at 13 and 32 C	OxGNiKIMo	The necessary biochemical tests, including oxidation of 10% lactose and test for pigment formation on MP
<i>Lactobacillaceae</i>	Counts in Rogosa et al.'s (119) acetate agar at 32 C	Microscopy, Ca	TAesLacMaltSaMaSoCell
Non- <i>Lactobacillaceae</i>	Counts in 0.5% gelysate trypticase agar at 32 C	Microscopy, Ca	If required: biochemical confirmation tests
Aerobic bacterial count	Counts in Mossel & Krugers Dagneaux's (84) TDYM-agar at 32 C ¹ or 13 C when psychrophilic or psychrotrophic organisms have to be enumerated (Mossel & v.d. Moosdijk, 92)		
Aerobic bacterial count	Counts in STAn (Mossel et al. 93) at 32 C		
Bacterial spore counts	Counts in TDYM, or STAn, after heating the suspensions for 1 min at 80 C (Mossel, 95)	Microscopy	MPN counts in BHIS at 48 ± 2 C after heating for 30 min at 110 C
Molds and yeasts	Counts in yeast extract glucose oxytetracyclin agar, ² incubated at 22 C (Beech & Carr, 4; Mossel, Visser & Mengerink, 87; Sainclivier & Roblot, 122; Koburger, 58)	Microscopy—but hardly necessary	
Ovolytic organisms	Plating on blood agar base with 0.5% NaCl and 2% egg yolk, and incubation at 32 C	If required: microscopy and further examination of egg yolk clearing and/or precipitating colonies	
Lipolytic organisms	Counts in a thin layer of suitable agar ³ layered over an appropriate lipid phase (Eijkman, 24; Tuyenburg Muys & Willemse, 146)	If required: microscopy and further examination of colonies surrounded by a precipitation zone	
Osmophilic organisms	Counts in 60 wt% fructose-0.5% yeast extract agar (a _w = 0.83) at 30 C (Mossel, 79; Mossel & Bax, 97)	If required: microscopy and further examination of colonies obtained	

¹If food sample is high in molds add 1000 µg/ml pimaricin (Mossel & Sand, 100)

²If food sample is high in mold spores which form copious aerial mycelia, add 1:15000 rose bengal (Smith & Dawson, 131)

³For bacteria, see aerobic count; for molds and yeasts see molds and yeasts above. If the food sample may contain lipases of non-microbial origin, it is recommended to correct for non-microbial lipase activity by spreading 0.1 ml of the 1:10 dilution on to plates containing oxytetracyclin pimaricin agar plus the standard fat layer (Mossel & Sand, 100)

TABLE 6. REPLICATION PROCEDURES RECOMMENDED FOR THE TENTATIVE TAXONOMIC GROUPING OF COLONIES, OBTAINED ON PRIMARY PLATES OF AEROBIC, GENERAL PURPOSE AGAR¹

Serial nr.	Conditions of replication subculture				Taxonomic group, predominantly selected by culture conditions	Colony type to be looked for	Further tests to be carried out with such colonies
	Medium used	Temp. °C	Incubation Time hr	pO ₂			
01 ²	Sugar-free agar with 0.5% NaCl and 1 ppm crystal violet	22-25	48	aer.	All Gram-negative, rod-shaped bacteria	Non pin-point colonies	Gram stain
02	Violet red bile glucose agar (88)	35-37	18-20	anaer.	<i>Enterobacteriaceae</i> and <i>Aeromonadaceae</i>	Colonies surrounded by purple halo of precipitate	Oxidase reaction Mode of attack on glucose
03	Chapman's mannitol 7.5% NaCl agar (151)	30-32	48	aer.	Catalase positive cocci	Regular, smooth, creamy colonies	Gram stain Catalase reaction
04	Baird-Parker's tellurite egg yolk pyruvate agar (2)	35-37	28-30	aer.	<i>S. aureus</i>	Anthracite black, smooth colonies, surrounded by a clear zone	Coagulase reaction
05 ²	Azide methylene blue 10 µg/ml kanamycin agar of pH = 8	35-37	48	anaer.	Lancefield group D streptococci	Small, regular, smooth colonies, bluish or white	Gram stain of broth culture Catalase reaction Growth at 45 ± 0.1 C
06	Rogosa et al.'s acetate agar of pH = 5.8 (119)	30-32	48-72	anaer.	<i>Lactobacillaceae</i>	Rather small, regular colonies	Gram stain Catalase reaction
07 ²	Infusion agar with 10 µg/ml polymyxin B sulphate	30-32	18-20	aer.	<i>Bacillaceae</i>	Irregular, dull, flat colonies	Gram stain
08 ³	Glucose infusion agar	30-32	28-30	aer.	None—but so far the only means of obtaining <i>Corynebacterium</i> , <i>Arthrobacter</i> , etc.	Other than those of cocci or <i>Bacillaceae</i> ; <i>vide supra</i>	Gram stain
09	Oxytetracylin glucose yeast extract agar (87)	22-25	48-72	aer.	Molds, yeasts, resp.	Mycelial, resp. regular and glistening colonies	Alkaline methylene blue stain

¹Trypticase glucose yeast extract peptonized milk agar (84), with Tween 80 (bacteriological grade) and Mg⁺⁺, Mn⁺⁺ and Fe⁺⁺ added.

²Media, developed for this purpose.

³Only to be used if a considerable fraction of replicated colonies will not develop on media 01-07 and 09.

Lancefield group D streptococci, and 46 C for *C. perfringens*; and (d) assays for tolerance of the classical selective inhibitors at the usual concentrations, e.g. azide, crystal violet, tellurite, etc.

All these tests can be carried out in large series which lend themselves to instrumentation. Similar, though somewhat modified tests are applied to the anaerobic "master plate."

In addition we have started a system of coding, storing, and retrieving the data obtained in this way. The front and back sides of cards found useful for this purpose are presented in Fig. 1 and 2.

Necessity of standards for finished products

It is a fruitless procedure to make these finished product examinations without having standards available against which the results obtained can be evaluated. Hence an essential part of microbiological quality control is the drafting of specifications.

The general principles of drafting standards have been presented in the third section of this paper. The numerical details of such an endeavor are the following. A representative number of samples of the commodity under study is taken from production lines previously checked for the absence of any technological and microbiological deficiencies. These samples are examined for the criteria for which standards have to be set up, in view of the health or spoilage record of the food under study. A tentative standard is then the figure met by over 90 or 95% of the samples subjected to this microbiological evaluation (137).

In finished product specifications, the time-temperature combination to which samples are to be exposed prior to testing also merits careful consideration. Preserved foods must obviously tolerate extensive periods of storage at temperatures up to 30-45 C, depending on their destination. But also with semi-preserved or even highly perishable foods, it is useful to store samples for some time at a suitable temperature before microbiological examination is carried out, with the purpose of being able to anticipate the bacteriological condition of the commodity as it reaches the consumer, in addition to checking the microbiological quality at the end of the manufacturing line.

RETROSPECTIVE EXAMINATIONS

There is a third and last aspect of microbiological quality control that should be mentioned. The author suggests that it be called retrospective microbiological quality control. It consists of microbiological examination of samples of consignments that have been returned to the manufacturer because of complaints, whether because of lack of microbiological stability, or because pathogenic or indicator

organisms have been detected at a level not acceptable to importing countries or buyers. The examination of such products should not be considered a nuisance, but should rather be looked upon as providing a valuable source of additional information on what may happen to the food under practical conditions.

When examining sub-standard samples, the package should firstly be examined very carefully for leakage (69). In addition, microbiological data on the contents can often be of considerable help in establishing the causes of the trouble. This was, for instance, our experience when charged with the bacteriological examination of canned meats of the solid pack type following the Aberdeen typhoid fever outbreak, allegedly caused by contaminated corned beef (46, 75). To test for potential sub-standard quality Most Probable Number (MPN) counts were made of *Enterobacteriaceae* and catalase-positive cocci in the material taken from the center and from the peripheral areas of the packs. A comparison of such sets of counts enabled us to estimate whether post-process recontamination of the commodity had occurred or not.

Particularly in the examination of foods preserved by other means than by heat, or not by thermal treatment exclusively, the antimicrobial parameters of the product (pH, a_w and concentration of natural or added inhibitory substances) should be checked, in order to assess whether the product might have been insufficiently preserved.

When the cause of the complaint is not detected by any of these types of examination, the microflora has to be studied in more detail. For this purpose, the methods summarized in Tables 3 and 5 can be used. When this is done in extensively spoiled samples, however, the counts found may not correspond to the amount of deterioration detected by organoleptic methods. This results from what is often called auto-sterilization, i.e. spontaneous dying off of part of the microflora, because of antimicrobial conditions created in the food by the initial microbial proliferation. In this event, a quantitative microscopical examination can first be attempted (20, 85).

In some instances, a large fraction of the microbial cells has lysed subsequent to death and microscopical examination does not then reveal significant abnormalities. It is our experience that a chemical search for specific microbial metabolites may then often yield the information required (82). When foods packed in hermetically sealed containers are examined, analysis of the gases found in the headspace (CO₂, H₂, and sometimes CH₄) may provide this answer (110). Generally, quantitative determination of other metabolites such as volatile aliphatic acids, lactic acid, succinic acid, acetyl methyl carbinol, and

nitrogenous substances like histamine or aliphatic amines, may give useful indications of the type of spoilage that has occurred (123). Very illustrative in this respect was an "epidemic" of spoilage in salad cream and egg nog which we studied recently. In both instances *Lactobacillaceae* appeared to be the cause of the spoilage phenomena. Only rather low viable or microscopic counts of these bacteria were found in some samples; but determination of the lactic acid content definitely established the etiological role of *Lactobacillaceae* in these instances too.

REFERENCES

1. Bacic, B., C. M. Cousins, and L. F. L. Clegg. 1968. Studies on the laboratory soiling of milking equipment. *J. Dairy Res.* 35:247-256.
2. Baird-Parker, A. C. 1962. An improved diagnostic and selective medium for isolating coagulase positive staphylococci. *J. Appl. Bacteriol.* 25:12-19.
3. Baross, J., and J. Liston. 1968. Isolation of *Vibrio parahaemolyticus* from the Northwest Pacific. *Nature* 217:1263-1264.
4. Beech, F. W., and J. C. Carr. 1955. A survey of inhibitory compounds for the separation of yeasts and bacteria in apple juices and ciders. *J. Gen. Microbiol.* 12:85-94.
5. Bladel, B. O., and R. A. Greenberg. 1965. Pouch method for the isolation and enumeration of clostridia. *Appl. Microbiol.* 13:281-285.
6. Bourdillon, R. E., O. M. Lidwell, and J. C. Thomas. 1941. A slit sampler for the collection and counting of air-borne bacteria. *J. Hyg.* 41:197-224.
7. Bulling, E. 1968. Die bakteriologische Ueberwachung von Eiprodukten in der Bundesrepublik Deutschland. *Arch. Lebensm. Hyg.* 19:78-80.
8. Bunker, H. J. 1967. Dealing with microbiological trouble-makers. In: *Biology and the Manufacturing Industries*. Brook, M. Editor. 63. Academic Press, London.
9. Buttiaux, R., J. Moriametz, and J. Papavassiliou. 1956. Méthode simplifiée d'identification des *Enterobacteriaceae* n'attaquant pas rapidement le lactose. *Ann. Inst. Pasteur Paris* 90:133-143.
10. Cate, L. 1965. A note on a simple and rapid method of bacteriological sampling by means of agar sausages. *J. Appl. Bacteriol.* 28:221-223.
11. Chapman, G. H. 1944. The isolation of streptococci from mixed cultures. *J. Bacteriol.* 48:113-114.
12. Chapman, G. H. 1951. A culture medium for detecting and confirming *Escherichia coli* in ten hours. *Am. J. Public Health* 41:1381.
13. Christensen, C. M., G. H. Nelson, and C. J. Mirocha. 1965. Effect on the white rat uterus of a toxic substance isolated from *Fusarium*. *Appl. Microbiol.* 13:653-659.
14. Christensen, W. B. 1946. Urea decomposition as a means of differentiating *Proteus* and paracolon cultures from each other and from *Salmonella* and *Shigella* types. *J. Bacteriol.* 52:461-466.
15. Colenso, R., G. Court, and R. J. Henderson. 1966. Fresh cream in Worcestershire: a bacteriological study. *Monthly Bull. Min. Health* 25:153-160.
16. Collins, R. N. et al. 1968. Interstate outbreak of *Salmonella newbrunswick* infection traced to powdered milk. *J. Am. Med. Assoc.* 203:838-844.
17. Cook, G. T. 1952. Comparison of two modifications of bismuth-sulphite agar for the isolation and growth of *Salmonella typhi* and *Salmonella typhimurium*. *J. Pathol. Bacteriol.* 64:559-566.
- 17a. Corlett, D. A., J. S. Lee, and R. O. Sinnhuber. 1965. Application of replica plating and computer analysis for rapid identification of bacteria in some foods. I. Identification scheme. *Appl. Microbiol.* 13:808-817.
18. Cowan, S. T., and K. J. Steel. 1965. Manual for the Identification of Medical Bacteria, Cambridge Univ. Press.
19. Dodd, D. C. 1965. Facial eczema in ruminants. In: *Mycotoxins in foodstuffs*, Wogan, G. N., Editor. Cambridge, Mass., 105-110.
20. Duitschaever, C. L., and G. C. Ashton. 1968. Comparison of counts using a Breed-type smear and millipore membrane methods on fresh and preserved milk samples. *J. Dairy Sci.* 51:665-667.
21. Edel, W., P. A. M. Guinée, M. van Schothorst, and E. H. Kampelmacher. 1967. *Salmonella* infections in pigs fattened with pellets and unpelleted meal. *Zentralbl. Vet. Med.* 14:393-401.
22. Ewing, W. H., B. R. Davis, and R. W. Reavis. 1957. Phenylalanine and malonate medium and their use in enteric bacteriology. *Public Health Lab.* 15:153-167.
23. Ewing, W. H., and M. A. Fife. 1966. A summary of the biochemical reactions of *Arizona arizonae*. *Int. J. Syst. Bacteriol.* 16:427-433.
24. Eijkman, C. 1901. Ueber Enzyme bei Bakterien und Schimmelpilzen. *Zentralbl. Bakteriol. Parasitenk. Abt. I*, 29:841-848.
25. Eijkman, C. 1904. Die Gärungsprobe bei 46° als Hilfsmittel bei der Trinkwasseruntersuchung. *Zentralbl. Bakteriol. Parasitenk. Abt. I*, 37: 742-752.
26. Fisher, E. E., A. W. Kelloch, and N. A. M. Wellington. 1967. Toxic strain of *Fusarium culmorum* (W.G.Sm.) Sacc. from *Zea mays* L., associated with sickness in dairy cattle. *Nature* 215:322.
27. Forgacs, J., W. T. Carll, A. S. Herring, and B. G. Mahlandt. 1954. A toxic *Aspergillus clavatus* isolated from feed pellets. *Am. J. Hyg.* 60:15-26.
28. Forgacs, J., W. T. Carll, A. S. Herring, and W. R. Hinshaw. 1958. Toxicity of *Stachybotris atra* for animals. *Trans. New York Acad. Sci.* 20:787-808.
29. Forgacs, J., and W. T. Carll. 1966. Mycotoxicoses: toxic fungi in tobaccos. *Science* 152:1634-1635.
30. Gantner, G., and L. Körmendy. 1968. Verfahren zur Bestimmung der ausreichenden Erhitzung von Fleischerzeugnissen mit dem Phosphatase-Test. *Fleischwirtschaft* 48:188-192.
31. Gerriets, E. 1967. Präventive hygienische Massnahmen in Junggeflügel - Mastbetrieben und Geflügelschlachtereien. *Fleischwirtschaft* 47:949-954.
32. Gilgan, M. W., E. B. Smalley, and F. M. Strong. 1966. Isolation and partial characterization of a toxin from *Fusarium tricinectum* on moldy corn. *Arch. Biochem. Biophys.* 114: 1-3.
33. Gillepsie, G. H. 1967. Laboratory tests for the hygienic quality of foods. *Chem. and Ind.* nr. 14, 588.
34. Giolitti, G., and C. Cantoni. 1966. A medium for the isolation of staphylococci from foodstuffs. *J. Appl. Bacteriol.* 29:395-398.
35. Goldenberg, N. 1968. Food quality control. *Food Manufacturing* 43(1):29-34.
36. Guinée, P. A. M., and D. A. A. Mossel. 1963. The reliability of the test of Mc.Kenzie, Taylor and Gilbert for the detection of faecal *Escherichia coli* strains of animal origin in foods. *Antonie van Leeuwenhoek* 29:163-168.
37. Hall, H. E. 1968. Enterotoxin and enzyme production by a selected group of *Staphylococcus aureus* cultures. *Bacteriol. Proc.* 77-78.

38. Harvey, R. W. S., and S. Thomson. 1953. Optimum temperature of incubation for isolation of salmonellae. *Monthly Bull. Min. Health. London.* 12:149-150.
39. Harvey, R. W. S., and T. H. Price. 1967. The isolation of salmonellas from animal feedingstuffs. *J. Hyg.* 65: 237-244.
40. Heard, T. W., N. E. Jennett, and A. H. Linton. 1968. The control and eradication of salmonellosis in a closed pig herd. *Vet. Rec.* 82:92-99.
41. Higgins, M. 1950. A comparison of the recovery rate of organisms from cottonwool and calcium alginate wool swabs. *Monthly Bull. Min. Health. London.* 9:50-51.
42. Hobbs, B. C. 1962. Salmonellae. In: *Chemical and Biological Hazards in Food.* Ayres, J. C. et al. Editors. 227. Iowa State Univ. Press. Ames, Iowa, U.S.A.
43. Hobbs, B. C. 1967. Health problems in quality control: Microbiological aspects. In: *Quality Control in the Food Industry.* Vol. 1. Herschdoerfer, S. M. Editor. 67. Academic Press, London.
44. Hodges, F. A., J. R. Zust, H. R. Smith, A. A. Nelson, B. H. Armbrecht, and A. D. Campbell. 1964. Mycotoxins: aflatoxin isolated from *Penicillium puberulum*. *Science* 145: 1439.
45. Holt, R. J. 1966. Pad culture studies on skin surfaces. *J. Appl. Bacteriol.* 29:625-630.
46. Howie, J. W. 1968. Typhoid in Aberdeen, 1964. *J. Appl. Bacteriol.* 31:171-178.
47. Hyndman, J. B. 1968. The pecan shelling industry of the Southwest. *FDA Papers,* 2(4):25-29.
48. Iizuka, H., and M. Iida. 1962. Maltoryzine, a new toxic metabolite produced by a strain of *Aspergillus oryzae*, var. *microsporus* isolated from the poisonous malt sprout. *Nature* 196:681-682.
49. Ingram, M., and T. A. Roberts. 1966. Microbiological principles. In: *Food Irradiation, Proc. Symp. Karlsruhe.* 267. IAEA, Wien.
50. Jarding, K. M. 1966. An outbreak of food poisoning following the consumption of infected pork pies. *Med. Officer,* 115:159-160.
51. Joffe, A. Z. 1962. Biological properties of some toxic fungi isolated from overwintered cereals. *Mycopathol. mycol. applic.* 16:201-221.
52. Johnston, R., S. Harmon and D. Kautter. 1964. Method to facilitate the isolation of *Clostridium botulinum* type E. *J. Bacteriol.* 88:1521-1522.
53. Jones, G. A., D. L. Gibson, and K. J. Cheng. 1967. Coliform bacteria in Canadian pasteurized dairy products. *Can. J. Public Health* 58:257-264.
54. Kampelmacher, E. H. 1967. Comparative studies into the isolation of *Salmonella* from minced meat in five laboratories. Report from a working group. *Zentralbl. Bakteriologie. Parasitenk. Abt. I, Orig.,* 204:100-111.
55. Kauffman, F. 1935. Weitere Erfahrungen mit dem kombinierten Anreicherungsverfahren für Salmonellabacillen. *Z. Hyg. Infekt. Krankh.* 117:26-32.
56. Kinoshita, R., and T. Shikata. 1965. On toxic moldy rice. In: *Mycotoxins in foodstuffs.* Wogan, G. N., Editor. Cambridge, Mass., 111-132.
57. Kligler, I. J. 1918. Modifications of culture media used in the isolation and differentiation of typhoid, dysentery and allied bacilli. *J. Exp. Med.* 28:319-322.
58. Koburger, J. A. 1968. Antibiotic-containing medium for the enumeration of fungi in foods. *Bacteriol. Proc.* 13.
59. Kovacs, N. 1956. Identification of *Pseudomonas pyocyanea* by the oxidase reaction. *Nature* 178:703.
60. Krogh, P., and E. Hasselager. 1968. Studies on fungal nephrotoxicity. *Royal Vet. and Agr. College, Copenhagen.* Yearbook 1968, 198-214.
61. Larsen, S. 1928. Om kronisk degeneration af nyerne (nefroze) hos svinforarsaget af skimlet rug. *Maanedsskr. Dyrk.* 40:259-284; 289-300.
62. Le Minor, L., and F. Ben Hamida. 1962. Avantages de la recherche de la β -galactosidase sur celle de la fermentation du lactose en milieu complexe dans le diagnostic bactériologique, en particulier des Enterobacteriaceae. *Ann. Inst. Pasteur* 102:267-277.
63. Lennington, K. R. 1967. The food-borne disease problem today. *J. Milk Food Technol.* 30:372-375.
64. Litsky, B. Y., and W. Litsky. 1968. Investigations on decontamination of hospital surfaces by the use of disinfectant-detergents. *Am. J. Public Health* 58:534-543.
65. Litsky, W., W. L. Mallmann, and C. W. Fifield. 1953. A new medium for the detection of enterococci in water. *Am. J. Public Health* 43:873-879.
66. Mac Conkey, A. 1905. Lactose-fermenting bacteria in faeces. *J. Hyg.* 5:333-379.
67. Mac Kenzie, E. F. W., E. W. Taylor, and W. E. Gilbert. 1948. Recent experiences in the rapid identification of *Bacterium coli* Type I. *J. Gen. Microbiol.* 2:197-204.
68. Marshall, R. S., Steenbergen, and L. S. Mc. Clung. 1965. Rapid technique for the enumeration of *Clostridium perfringens*. *Appl. Microbiol.* 13:559-563.
69. Maunder, D. T., J. F. Folinazzo, and J. J. Killoran. 1968. Bio-test method for determining integrity of flexible packages of shelf-stable foods. *Food Technol.* 22:615-618.
70. May, K. R. 1966. Multistage liquid impinger. *Bacteriol. Rev.* 30:559-570.
71. Mc Coy, J. H. 1967. Total bacterial and coliform counts as indices of the hygienic quality of foods. *Chem. and Ind.* 587-588.
72. Mc Erlean, B. A. 1952. Vulvovaginitis of swine. *Vet. Record* 64:539-540.
73. Merwe, K. J. van der, P. S. Steyn, L. Fourie, D. B. Scott, and J. J. Theron. 1965. Ochratoxin A, a toxic metabolite produced by *Aspergillus ochraceus* Wilk, *Nature* 205: 1112-1113.
74. Midura, T. F., Y. Inouy, and H. L. Bodily. 1967. Use of immunofluorescence to identify *Clostridium botulinum* types A, B and E. *Public Health Rep. Wash.* 82:275-279.
75. Milne, D. 1964. The Aberdeen typhoid outbreak 1964. Report of the Department Committee of Enquiry. H. M. Stationery Office, Edinburgh, 74 p.
76. Mirocha, C. J. C. M. Christensen, and G. H. Nelson. 1967. Estrogenic metabolite produced by *Fusarium graminearum* in stored corn. *Appl. Microbiol.* 15:497-503.
77. Miyake, M., and M. Saito. 1965. Liver injury and liver tumors induced by toxins of *Penicillium islandicum* Sopp growing on yellowed rice. In: *Mycotoxins in foodstuffs.* Wogan, G. N., Editor. Cambridge, Mass. 133-146.
78. Mortimer, P. H. 1963. The experimental intoxication of sheep with sporidesmin, a metabolic product of *Pithomyces chartarum*. IV. Histological and histochemical examinations of orally dosed sheep. *Res. Vet. Sci.,* 4:166.
79. Mossel, D. A. A. 1951. Investigation of a case of fermentation in fruit products, rich in sugars. *Antonie Van Leeuwenhoek,* 17:146-152.
80. Mossel, D. A. A. 1955. The importance of the bacteriological condition of ingredients used as minor components in some canned meat products. *Ann. Inst. Pasteur Lille* 7:171-185.
81. Mossel, D. A. A., and M. Ingram. 1955. The physiology of the microbial spoilage of foods. *J. Appl. Bacteriol.* 18:232-268.

82. Mossel, D. A. A., and F. D. Tollenaar. 1955. A simple test for use in experiments on the occurrence and the prevention of microbial lipolytic spoilage in foods. *Antonie van Leeuwenhoek* 21:247-251.
83. Mossel, D. A. A. 1959. Enumeration of sulphite-reducing clostridia occurring in foods. *J. Sci. Food Agri.* 10:662-669.
84. Mossel, D.A.A., and E. L. Krugers Dagneaux. 1959. Bacteriological requirements for and bacteriological analysis for precooked ("instant") cereals and similar foods. *Antonie van Leeuwenhoek* 25:230-236.
85. Mossel, D. A. A., and H. Zwart. 1959. Die quantitative bakterioskopische Bewertung von Gemüse/Fleischkonserven. *Arch. Lebensm. Hyg.* 10:229-232.
86. Mossel, D. A. A., and G. Martin. 1961. Milieu simplifié permettant l'étude des divers modes d'action des bactéries sur les hydrates de carbone. *Ann. Inst. Pasteur Lille* 12:225-226.
87. Mossel, D. A. A., M. Visser, and W. H. J. Mengerink. 1962. A comparison of media used for the enumeration of moulds and yeasts in foods and beverages. *Lab. Pract.* 11:109-112.
88. Mossel, D. A. A., W. H. J. Mengerink, and H. H. Scholts. 1962. Use of a modified McConkey agar medium for the selective growth and enumeration of *Enterobacteriaceae*. *J. Bacteriol.* 84:381.
89. Mossel, D. A. A. 1963. The rapid evaluation of disinfectants intended for use in food processing plants. *Lab. Pract.* 12:898-899.
90. Mossel, D. A. A., M. Visser, and A. M. R. Cornelissen. 1963. The examination of foods for *Enterobacteriaceae* using a test of the type generally adopted for the detection of salmonellae. *J. Appl. Bacteriol.* 24:444-452.
91. Mossel, D. A. A. 1964. Essentials of the assessment of the hygienic condition of food factories and their products. *J. Sci. Food Agr.* 15:349-362.
92. Mossel, D. A. A., and A. van de Moosdijk. 1964. The practical significance in the microbiological examination of cold stored foods of the allegedly low heat resistance among psychrotrophic micro-organisms. *J. Appl. Bacteriol.* 27:221-223.
93. Mossel, D. A. A., et al., 1965. Etude des milieux utilisés pour le dénombrement des spores des bactéries anaérobies en microbiologie alimentaire. *Ann. Inst. Pasteur Lille* 16:147-156.
94. Mossel, D. A. A., E. H. Kampelmacher, and L. M. van Noorle Jansen. 1966. Verification of adequate sanitation of wooden surfaces used in meat and poultry processing. *Zentralbl. Bakteriolog. Parasitenk. Abt. I, Orig.* 201:91-104.
95. Mossel, D. A. A. 1967. Ecological principles and methodological aspects of the examination of foods and feeds for indicator microorganisms. *J. Assoc. Offic. Anal. Chem.* 50:91-104.
96. Mossel, D. A. A., M. van Schothorst, and E. H. Kampelmacher. 1967. Comparative study on decontamination of mixed feeds by radication and by pelletisation. *J. Sci. Food Agr.* 18:362-367.
97. Mossel, D. A. A., and A. W. Bax. 1967. Selektive Zählung von züchtbaren osmophilen Hefen in Lebensmitteln niedrigen w -Wertes. *Mitt. Geb. Lebensm. Untersuch. Hyg.* 58:154-155.
98. Mossel, D. A. A., N. J. Koopman, and E. Jongerius. 1967. Enumeration of *Bacillus cereus* in foods. *Appl. Microbiol.* 15:650-653.
99. Mossel, D. A. A., et al. 1968. Objectief onderzoek naar de hygiënische gesteldheid van grote keukens. *Voeding* 29:105-123.
100. Mossel, D. A. A. and F. E. M. J. Sand. 1968. Occurrence and prevention of microbial deterioration of confectionery products. *Conserva* 17:23-32.
101. Mossel, D. A. A., and H. Vincentie. 1968. The differential enterobacteriogramme—a refined method for the assessment of the bacteriological condition of processed foods. *Lab. Pract.* 17:1344-1346.
102. Mossel, D. A. A., and J. de Waart. 1968. The enumeration of clostridia in foods and feeds. *Ann. Inst. Pasteur Lille.* 19:13-27.
103. Muller, L. 1923. Un nouveau milieu d'enrichissement pour la recherche du Bacille typhique et des paratyphiques. *Compt. Rend. Soc. Biol.* 89:434-437.
104. Musa, R. C., and G. L. Schnable 1965. *In: Humidity and moisture.* Wexler, A. Editor. Vol. I, 346. Reinhold Publ. Corp., New York.
105. Narayan, K. G. 1967. Culture isolation and identification of clostridia. *Zentralbl. Bakteriolog. Parasitenk. Abt. I, Orig.* 202:212-220.
106. Newell, K. W. 1967. Possibilities for investigation and control of salmonellosis for this decade. *Am. J. Public Health.* 57:472-476.
107. Nikodemusz, I. 1966. Comparaison du pouvoir pathogène expérimental de *Bacillus cereus* et de *Bacillus laterosporus* administrés par voie orale. *Ann. Inst. Pasteur Lille.* 17:229-232.
108. North, W. R., and M. T. Bartram. 1953. The efficiency of selenite broth of different compositions in the isolation of *Salmonella*. *Appl. Microbiol.* 1:130-134.
109. North, W. R. 1961. Lactose pre-enrichment method for isolation of *Salmonella* from dried egg albumen. Its use in a survey of commercially produced albumen. *Appl. Microbiol.* 9:188-195.
110. O'Brien, R. T. 1967. Differentiation of bacteria by gas chromatographic analysis of products of glucose catabolism. *Food Technol.* 21:1130-1132.
111. Olson, H. C. 1961. Selective media for detecting spoilage organisms in dairy products. *J. Dairy Sci.* 44:970-971.
112. Packer, R. A. 1943. The use of sodium azide (NaN_3) and crystal violet in a selective medium for streptococci and *Erysipelothrix rhusiopathiae*. *J. Bacteriol.* 46:343-349.
113. Perry, C. A. 1928. Studies relative to the significance of the present oyster scare. *Am. J. Hyg.* 8:694-722.
114. Rabie, C. J., M. Terlanche, J. D. Smit, and W. A. de Klerk. 1965. Toxicity of *Aspergillus wentii* Wehmer. *South Afric. J. Agr. Sci.* 8:875-880.
115. Read, R. B., and A. L. Reyes. 1967. Enrichment procedure for *Salmonella* in raw milk. *J. Dairy Sci.* 50:946.
116. Read, R. B., and A. L. Reyes. 1968. Variation in plating efficiency of salmonellae on eight lots of brilliant green agar. *Appl. Microbiol.* 16:746-748.
117. Rehm, H. J. 1967. Mykotoxine und ihre Bedeutung für die Lebensmittelchemie. *Deut. Lebensm. Rundschau.* 63:269-272.
118. Richards, M. 1955. A water-soluble filter for trapping airborne micro-organisms. *Nature* 176:559.
119. Rogosa, M., J. A. Mitchell, and R. F. Wiseman. 1951. A selective medium for the isolation and enumeration of oral and fecal lactobacilli. *J. Bacteriol.* 62:132-133.
120. Rollender, W. et al. 1968. Comparison of xylose lysine deoxycholate agar and MacConkey agar for the isolation of *Salmonella* and *Shigella* from clinical specimens. *Bacteriol. Proc.* 106-107.
121. Rutqvist, L. and P. A. Persson. 1966. Studies on *Aspergillus fumigatus* experimental mycotoxicosis in mice,

- chicks, and pigs with the appearance in pigs of perirenal edema. *Acta Vet. Scand.* 7:21-34.
122. Sainclivier, M., and A. M. Roblot. 1966. Choix d'un milieu de culture pour le dénombrement des levures et moisissures dans le beurre. *Ann. Inst. Pasteur Lille* 17:181-187.
123. Salwin, H. 1968. Report on decomposition and filth in foods (Chemical indexes). *J. Assoc. Offic. Anal. Chem.* 51:281-283.
124. Sarkany, I., and C. C. Gaylarde. 1967. Effect of hexachlorophene on resident skin flora of newborns. *Lancet* II, 866-868.
125. Saulmon, E. E. 1966. Control of *Salmonella* contamination in eggs, feeds and feed products. *J. Am. Vet. med. Ass.* 149:1691-1697.
126. Schulz, M. E., E. Voss, and K. H. Leder. 1968. Versuchseinrichtungen für milchwirtschaftliche Technologie. Teil I.—Versuchsräume und Geräte für "Infektionsfreie Arbeiten." *Milchwissenschaft* 23:137-147.
127. Scott, D. 1965. Toxigenic fungi isolated from cereal and legume products. *Mycopathol. Mycol. Appl.* 25:213.
128. Sellers, W. 1964. Medium for differentiating the Gram-negative, nonfermenting bacilli of medical interest. *J. Bacteriol.* 87:46-48.
129. Shelton, L. R. 1961. Frozen precooked foods—plant sanitation and microbiology. *J. Am. Diet. Assoc.* 38:132-134.
130. Simmons, J. S. 1926. A culture medium for differentiating organisms of typhoid-colon aerogenes groups and for isolation of certain fungi. *J. Infect. Dis.* 39:209-214.
131. Smith, N. R., and V. T. Dawson, 1944. The bacteriostatic action of rose bengal in media used for plate counts of soil fungi. *Soil Sci.* 58:467-471.
132. Spensley, P. C., and R. J. Townsend. 1967. Toxic fungal products. In: *Biology and the Manufacturing Industries*. Brook, M., Editor. 103. Academic Press, London.
133. Steiner, E. H. 1967. Statistical methods in quality control. In: *Quality Control in the Food Industry*. Herschdoerfer, S. M., Editor. 121. Academic Press, London.
134. Stob, M., R. S. Baldwin, J. Tuite, F. N. Andrews, and K. G. Gilette. 1962. Isolation of an anabolic, uterotrophic compound from corn infected with *Gibberella zeae*. *Nature* 196:1318.
135. Stodola, F. H., and L. R. Lockwood. 1947. Oxidation of lactose and maltose to bionic acids by *Pseudomonas*. *J. Biol. Chem.* 171:213.
136. Stumbo, C. R. 1965. *Thermobacteriology in Food Processing*. Academic Press, New York.
137. Surkiewicz, B. F., R. J. Groomes, and L. R. Shelton. 1968. Bacteriological survey of the frozen prepared foods industry. IV. Frozen breaded fish. *Appl. Microbiol.* 16:147-150.
138. Tatsuno, T. 1964. Metabolites of *Penicillium islandicum* Sopp. *Food and Cosm. Toxicol.* 2:678-680.
139. Taylor, W. I. 1961. Isolation of salmonellae from food samples. V. Determination of the method of choice for enumeration of *Salmonella*: *Appl. Microbiol.* 9:487-490.
140. Taylor, W. I., and B. Harris. 1965. Isolation of shigellae. II. Comparison of plating media and enrichment broths. *Am. J. Clin. Pathol.* 44:476-479.
141. Taylor, W. I., and D. Schelhart. 1968. Isolation of Shigella. VI. Performance of media with stool specimens. *Appl. Microbiol.* 16:1387-1393.
142. Theron, J. J., K. J. van der Merwe, N. Liebenberg, H. J. B. Joubert, and W. Nel. 1966. Acute liver injury in ducklings and rats as a result of ochratoxin poisoning. *J. Pathol. Bacteriol.* 91:521-529.
143. Thomas, M. 1961. The sticky film method of detecting skin staphylococci. *Monthly Bull. Min. Health London* 20:37-40.
144. Thornton, R. H., and J. C. Percival. 1959. A hepatotoxin from *Sporidesmium bakeri* capable of producing facial eczema diseases in sheep. *Nature* 183:63.
145. Townsend, R. J., M. O. Moss, and H. M. Peek. 1966. Isolation and characterization of hepatotoxins from *Penicillium rubrum*. *J. Pharm. Pharmacol.* 18:471.
146. Tuynenburg Muys, G., and R. Willemse. 1965. The detection and enumeration of lipolytic micro-organisms by means of a modified Eijkman-plate method. *Antonie van Leeuwenhoek* 31:103-112.
147. Vernon, E. 1967. Food poisoning in England and Wales. 1966. *Monthly Bull. Min. Health London* 26:235-249.
148. Vries, P. J. de, and M. Knappe. 1964. Enkele aspecten van de handdesinfectie. *Ned. Tijdschr. Geneesk.* 108:1302-1305.
149. Walbeck, W. van, P. M. Scott, and F. S. Thatcher. 1968. Mycotoxins from food-borne fungi. *Can. J. Microbiol.* 14:131-137.
150. Waart, J. de, and F. Smit. 1967. The enumeration of obligately anaerobic bacteria using pouches made from plastics with a low oxygen permeability. *Lab. Pract.* 16:1098-1099; 1105.
151. Waart, J. de, D. A. A. Mossel, R. ten Broeke, and A. van de Moosdijk. 1968. Enumeration of *Staphylococcus aureus* in foods with special reference to egg-yolk reaction and mannitol-negative mutants. *J. Appl. Bacteriol.* 31:276-285.
152. Willis, A. T., and G. Hobbs. 1959. Some new media for the isolation and identification of clostridia. *J. Pathol. Bacteriol.* 77:511-521.
153. Wilson, B. J., and C. H. Wilson. 1962. Extraction and preliminary characterization of a hepatotoxic substance from cultures of *Penicillium rubrum*. *J. Bacteriol.* 84:283-290.
154. Wilson B. J., and C. H. Wilson. 1964. Toxin from *Aspergillus flavus*: Production on food materials of a substance causing tremors in mice. *Science* 144:177-178.
155. Wilson, B. J. 1966. Toxins other than aflatoxins produced by *Aspergillus flavus*. *Bacteriol. Rev.* 30:478-484.
156. Wilson, B. J., T. M. Harris, and A. W. Hayes. 1967. Mycotoxin from *Penicillium puberulum*. *J. Bacteriol.* 93:1737-1738.
157. Wilson, B. J., T. C. Campbell, A. W. Hayes, and R. T. Hanlin. 1968. Investigation of reported aflatoxin production by fungi outside the *Aspergillus flavus* group. *Appl. Microbiol.* 16:819-821.
158. Wilson, G. S. 1955. Symposium on food microbiology and public health: general conclusions. *J. Appl. Bacteriol.* 18:629-630.
159. Winter, C. E., and L. A. Sandholzer. 1946. Isolation of enterococci from natural sources. *J. Bacteriol.* 51:588.
160. Yates, S. G., H. L. Tookey, J. J. Ellis and H. J. Burkhardt. 1968. Mycotoxins produced by *Fusarium nivale* isolated from tall fescue (*Festuca arundinacea* Schreb.) *Phytochem.* 7:139-146.
161. Zehren, V. L., and V. F. Zehren. 1968. Relation of acid development during cheesemaking to development of staphylococcal enterotoxin A. *J. Dairy Sci.* 51:645-649.
162. Zen-Yoji, H., S. Sakai, T. Terayama, Y. Kudo, T. Ito, M. Benoski, and M. Nagasaki. 1965. Epidemiology, enteropathogenicity and classification of *Vibrio parahaemolyticus*. *J. Infect. Dis.* 115:436-444.
163. Zipplies, G. 1964. Salmonellenfunde bei der tierärztlichen Lebensmittelüberwachung. *Monatsh. Vet. Med.* 19:588-591.

THE BIGGEST PROBLEM IN FOOD HYGIENE—PEOPLE

F. ORIS BLACKWELL

*Department of Environmental Sciences
College of Agriculture and Environmental Science
Rutgers-The State University
New Brunswick, New Jersey 08903*

(Received for publication September 26, 1968)

ABSTRACT

The importance of the behavior of the people who are involved in food handling is emphasized. It is through their behavior that potential health hazards are avoided and acceptable standards of cleanliness are maintained. Education is seen as the key to the modification of or the change of behavior. Food handler's training courses "as usually given" are criticized and suggestions are offered for improving the courses. The place of the sanitarian in these programs is reviewed. While health departments have usually conducted the training programs, there are certain disadvantages involved. Perhaps the responsibility in this area should rest with the food industry.

The late J. L. Pomeroy is quoted as saying, "It isn't the hazard of 10 waitresses contaminating the glassware that serves 1,000 people that is the matter for concern. It is the 1,000 persons whom the waitresses have served; there is the real danger" (1). The potential for food-borne disease is very great. The actual amount of illness that is transmitted through food is not known, but The Gross Report conservatively estimates that one million cases of food poisoning occur annually in the United States (21). The million cases would not, of course, include food-borne illnesses, not classified as food poisoning, which I believe are more prevalent than generally thought to be. If a food serves as a vehicle for food poisoning, then obviously this food is also capable of carrying other diseases, because of its exposure to contamination and favorable environmental conditions. These other diseases may include those caused by the enteric viruses such as infectious hepatitis, poliomyelitis and others, some higher fungi (molds), protozoa such as *Endameba histolytica*, various of the nematodes and helmenthic ova, as well as the bacterial agents both enteric, e.g. *Salmonella typhimurium* and the recently discovered *Vibrio parahemolyticus* (Sakazakia, 1963) and the respiratory group such as the hemolytic streptococci (13). Most disease agents get into food because of things done or things not done by persons responsible for some phase of food production, transportation, processing, preparation, storage, or serving.

In food sanitation programs, the traditional role of communicable disease prevention is still valid. Because the spectacular outbreaks of typhoid fever,

scarlet fever, and diptheria have been eliminated, this aspect has been given, in my opinion, less importance than it deserves. It may well be, however, that even that attention which has been paid to the control of food-borne disease has been misdirected. Perhaps we should have noted with more care the words of C. V. Chapin when he commented on the conquest of acute infectious diseases in 1934.

"We have learned the true nature of infection and we have learned that the parasites which are its essence rarely propagate in filth and are seldom air-borne. We have, in the language of a distinguished American hygienist, been to a large extent 'barking up the wrong tree.' Instead of indiscriminate attack on dirt, we must learn the nature and mode of transmission of each infection, and discover its most vulnerable point of attack. Some of the most recent works on sanitation still reiterate the time-worn phrase about dirt and disease. The daily press, and even the medical press, speaks as if street cleaning, scavenging, modern plumbing, and tenement house reform were the mainstay in fighting infection and reducing the death rate. The majority of even intelligent people today believe that Havana was made healthy by municipal engineering, while it was really accomplished by scientific effort specifically directed against infections. Our medical schools are also doubtless at fault, for many of even our younger physicians look for the source of malaria, typhoid fever, and diptheria in 'unsanitary conditions' by which they usually mean defective plumbing, decaying vegetation, heaps of stable manure, or general yard rubbish. The great problem of sanitation today is how to deal with mild or recognized cases of contagious disease and with those persons who, though well, are yet infected. This problem is not likely to be solved so long as physicians trace infection to the class of things mentioned instead of to persons" (5).

To what extent have we, that is the sanitarians and the public health engineers, been "barking up the wrong tree?" Looking back to the 1943 U. S. Public Health Service *Recommended Ordinance and Code for Eating and Drinking Establishments*, we find its main emphasis was on physical elements of the environment. For example, things that could be measured: cleanability of surfaces (smoothness), foot candles, and face-velocity of air to check ventilation via hoods; not to mention the hoods themselves and the three-compartment sink. At least, if the ordinance itself did not stress "things", those who were

undertaking the control of food-borne disease under the ordinance stressed "things." Sanitarians came to be known as the "floors, walls, and ceilings men." Physical things are important, but they are, I believe, considerably less important than people in the prevention of food-borne illness. The 1962 revision of the U. S. Public Health Service model ordinance has listed the sanitation items in a different order with "floors, walls and ceilings" listed in the last section F, and from the last place on the 1943 list "personnel" has moved up to section C, which is a step in the right direction (20).

CHANGES IN FOOD TECHNOLOGY

Food handlers are also the critical factor in what Lemaul Shattuck, in 1850, suggested was very important to the welfare of the population; the prevention of the intentional or unintentional addition of harmful substances to food (15). The revolution in food technology since Shattuck's time has increased a thousandfold the possibility of harmful food additives reaching large numbers of people from even one mistake. Pesticides, herbicides, and animal feed additives are examples of substances that may reach the consumer in his food (from the producer). Whenever food-stuff is processed chemical substances may be a hazard as well as disease transmission in the traditional sense. One figure that indicates the increase in the processing of food is this from the frozen food industry: the frozen food output in the U. S. in 1942 was 647.5 million pounds. In 1959 the total had risen to 6,565 million pounds (13). Practically all of the food which is consumed today in the United States has been handled by many people before it reaches the consumer. In the U. S. 78 million meals were eaten away from home each day of 1962 (19). This figure would likely be higher for 1968. The problem of the control of potential hazards in food is great and becoming greater, and methods of coping with the problem must also expand.

FOOD HANDLER'S NEED ATTENTION

I think the problem of people involved in food handling has not been given adequate attention in part because it is considerably more difficult to deal with the human element than it is to engineer and to measure (with a meter or tape that is). There have been some attempts to meet the "people-problem" in food hygiene, but often without remarkable success. One of the earliest attempts was the food handler's HEALTH CARD which was required by law and was renewed annually after a physical examination. This examination usually consisted of a chest x-ray, a Wasserman Test, and sometimes a stool examination. I believe that health cards on this

basis are now generally recognized for what they are; case-finding techniques perhaps, but not valid parts of a food hygiene program. Tuberculosis and syphilis are seldom transmitted through food! Even if they were, a worker could manage to have the disease and a valid "Health Card" for about 11 months of each year. The card system had some value in that it made the food worker known to the health department and vice versa.

TRAINING OF FOOD HANDLERS

A second and more meaningful program aimed at the human element is the training of food handlers in food hygiene. The military, during World War II, developed short course training programs for their food service workers. Following the war, several state health departments and many local health departments undertook to give food handler's training. The mark of a progressive sanitation division was whether or not it conducted a food handler's training course as part of its food sanitation program. California State Health Department published a guide for conducting a food sanitation class in 1950 and a revised edition in 1956. Three communities in California, according to the above reference, have compulsory food handler's courses for all food workers in their jurisdictions, and over the years many courses have been held on a more or less voluntary attendance basis. The California guide mentions studies done in 1950 and 1951 to determine the effectiveness of food sanitation training programs. The results, they say, "indicated that the training of restaurant personnel does produce a recognizable improvement (4). There was a survey evaluation done in a community in Massachusetts where the rating score rose from 20.8% in 2 years time to 79.6% (1944-1946), (8). At the time of the first rating, the community had no food sanitation program at all, and during the interval between ratings they developed a fairly complete program which included food handler's training. I do not think that there have been any really valid evaluation of these training courses. However, there is a growing concern that the courses as given are not meeting the problem.

ARE COURSES ADEQUATE?

If they are not, we should not be surprised. The key phrase is "as usually given." As usually given, the course is between 6 and 10 hr of instruction given in 3 to 5 sessions. These sessions are broadly laced with 16 mm films that were made 15 to 20 years ago and are not very topical. The "students" are usually coerced to attend either by their employer, or more likely the health department, after a full shift of work. Those instructing the classes

are handicapped by too little time in the course to do more than generalize, by having pressure of other work, and often by having no special training or aptitude for teaching adults. A critical review of the course content is beyond the scope of this paper, but one comment is appropriate. The California guide suggests seven subjects: Bacteria and Disease, Personal Hygiene and Food Service, Food Protection, Dishwashing, Good Housekeeping, Rodent and Insect Control, and Laws and Inspections (4). These subject areas are quite standard as they appear in almost every course outline. These may well be proper subjects, but are they all equally important as is usually implied and each worth only an hour? Another major weakness of the courses as they are usually given is that they seldom involve the operators and the managers. *Without the "boss" giving visible moral support, without him knowing what the food worker knows, without any planned followup of instruction, change in behavior of the "trainee" is quite unlikely or at least haphazard.*

Are food handler's training courses to be abandoned along with the x-rays and the Wassermans? There does not seem to be any plausible alternative way to change behavior except through education. Coercion works as long as "the gun is at the back," but lasting change is only with a change of will. It is probably in this that the food handler's courses have fallen short. It is not the failure of education per se, but rather a failure to educate.

We know that everybody does not hold health in the same high regard that we health workers do, and yet we assume that food handlers will readily accept our value judgement and will forthwith change their behavior accordingly. Perhaps this doesn't happen. There is not space to expound on this important area, but it surely must be a factor in the evaluation of any training program.

Education is a process which occurs to and within people. Education must include change; a change of attitude which leads to a change of behavior (9). Very often, I think, we equate knowledge with education. One educator has said, "(it) . . . is a gross over-simplification to assume that knowledge is sufficient to change behavior (this) is very naive" (7). Knowledge or ignorance is only one factor. Other factors are the value orientations and the habits and customs of the people seeking education. Habits and customs arise because these ways of behavior fulfill some need the individual has. These may persist because they continue to fill a need or because the ways have become expected or routine. I suspect that a large part of the food handler's activity and behavior is routine and habitual.

Food handler's are not a special breed of people with a special culture and a special set of values.

They are a fair cross section of the general population; and, I would suspect, just about as varied. They do, of course have special skills and knowledge which is relevant to food handling; some of which pertains to food hygiene. Training programs should not only take the special knowledge of the food handler into consideration, but should utilize it to the fullest extent in developing curriculum and teaching methods.

THE TEACHER'S RESPONSIBILITY

I believe there is truth in the old saw that if the student hasn't learned, the teacher hasn't taught. This puts a great obligation on the teacher, especially if he is teaching adults. It is a risky thing for an instructor to lay down all the rules and answers. No matter how acceptable these may be to him, his adult students may not accept them. "It indicates a subtle lack of respect for other persons—for their ability to cope, for their values . . . even if he (the tutor) is right and he very well may be (6)." Exploring for solutions with the students is a reasonable way to gain student acceptance of the concepts developed. Thus the instructor may go step by step with the students in the development of the theme, improved food hygiene practice. This method would surely require more time than the 6 to 10 hr allowed. It would also require a competence that most sanitarians do not now have but could certainly acquire. The instructor must have a depth of knowledge about the actual food preparation or processing in the industry; he must have a proper perspective of the health hazards and the aesthetics involved; and, perhaps this is the most important, he must be an able teacher of adults. I think this area presents a real challenge to the sanitarian. The sanitarians are, more than any other group, in a unique position to fill this need.

CRITICAL EVALUATION OF EDUCATIONAL PROGRAMS

If health departments are going to continue to give food handler's training courses, the methods and techniques by which this training is to be accomplished must be looked at more critically than we have in the past. But perhaps the health department is not the best organization to conduct food handler's training. The health department has several disadvantages. There is a stigma of police power and legal enforcement attached to most environmental health divisions. Those instructing often lack in background or aptitude in teaching, and are not well enough versed with the food industry. One of the most serious disadvantages is that the health department is seldom in a position to follow-up the training in the on-the-job practical application. Health agencies

also offer some advantages. They usually have some status or prestige in the community which adds luster to the course. Personnel of the health department have a wide range of specialities from which talent can be drawn.

An alternative to health department operated courses which is gaining acceptance is to place the responsibility for employee training in food hygiene squarely with the employers, i.e., industry. It is likely that industry will do more of this training. It is good business for a restaurant or a food industry to maintain high standards, and it is recognized by many that personnel performance is a key factor (2, 17, 18). A third possibility is that educational institutions could operate courses on a fee basis with the individual or industry paying the bill.

REFERENCES

1. Adams, H. S. 1947. Milk and Food Sanitation Practice. N. Y. Commonwealth Fund. p. 233.
2. American Dietetic Association. 1947. A Guide to the Selection and Training of Food Service Employees. Burgess Publishing Co., Minneapolis.
3. Buchbinder, L. 1961. Current status of food poisoning control. Public Health Rep. 76:515-520.
4. California State Department of Public Health. 1956. Food Sanitation in Commercial Establishments, A Guide for Teaching Food Handling. p. 3.
5. Chapin, C. V. 1934. Papers of Charles V. Chapin, M.D. Oxford University Press, New York and London.
6. Cleugh, Mary F. 1962. Educating Older People, Travistock Publications, London. p. 158.
7. Cousins, W. J. 1960. Community development, Rural Health Digest 2(2):7.
8. Gerber, M. 1953. Restaurant sanitation. Sanitalk 1(4):19.
9. Jensen, G. 1959. Guideposts for adult instruction. Adult Education 9(3):177.
10. Klock, J. W. 1964. The sanitary scientist of 1970. Public Health Rep. 79:71.
11. Hatem, J. M. 1961. Food-toxi-infections in Lebanon. Presse Medicine, Beirut, Lebanon. p. 670.
12. Ministry of Health. Department of Health for Scotland. 1958. Clean Catering. London.
13. National Academy of Sciences. 1964. An Evaluation of Public Health Hazards from Microbial Contamination of Foods, Washington, D. C., p. 16-17, 22.
14. National Council on Hotel and Restaurant Education. 1958. Directory of Schools and Colleges. Washington, D. C.
15. Shattuck, L. 1948. Report of the Sanitary Commission of Massachusetts 1850. Facsimile edition, Harvard University Press. p. 220.
16. Staton, Thomas F. 1960. How to Instruct Successfully, Modern Methods in Adult Education. McGraw Hill Book Co., Inc. N. Y.
17. Stauffer, L. D. 1964. Safe food handling requires health conscious food handler's. Hospitals 38(18):88-113.
18. Stokes, John W. 1960. Food Service in Industry and Institutions. Wm. Brown Co., Inc., Dubuque, Iowa.
19. Tennessee Department of Health. 1963. Tennessee Public Health 12(2):3.
20. U. S. Public Health Service. 1962. Food Service Sanitation Manual. Washington, D. C. p. 25.
21. U. S. Public Health Service. 1962. Report of the Committee on Environmental Health Problems. (Gross Report) Washington, D. C. p. 140.
22. Westervelt, A. 1961. Stretching the adult educators. Adult Education 11(2):99-105.

INFLUENCE OF 32 AND 37 C INCUBATION TEMPERATURES ON COUNTS OF COLIFORM BACTERIA OF MILK¹

D. L. MALLETT, R. T. MARSHALL AND J. E. EDMONDSON

Department of Food Science and Nutrition
University of Missouri, Columbia 65201

(Received for publication January 9, 1969)

ABSTRACT

Samples of raw and pasteurized milk were plated in desoxycholate lactose agar and incubated at 32 C \pm 1.0 and 37 C \pm 1.0 for enumeration of coliform bacteria. The lower temperature produced counts comparable to those at 37 C. Pasteurized samples yielded coliform-type bacteria which had 5 different IMViC test patterns, whereas 6 patterns were found among the isolates from raw milk. The most predominant pattern was - + + + and existed among 33% of the isolates.

This study was designed to determine if incubation temperatures of 32 or 37 C were selective toward any particular type or types of coliform organisms (as characterized by the IMViC test) and whether more organisms could be recovered from raw or pasteurized milk using either incubation temperature. *Standard Methods (1)* now requires the use of 32 C.

The literature is somewhat confusing in respect to the optimum incubation temperature for coliform bacteria. Boniece and Mallan (3) reported the optimum growth temperature for *Escherichia coli* and *Aerobacter aerogenes* as in the range of 37 to 39 C and the most favorable incubation temperature for the entire coliform group as 35 C. Murry (8) found that more colonies grew on MacConkey's agar at 30 than at 37 C when raw and pasteurized milks were examined. However, after examining 416 samples of milk, Lawton (7) found no significant difference in the number of coliform colonies yielded at 32 and 35 C. Thomas, et al., (9) isolated bacteria of the coli-aerogenes group from 825 samples at 30 C and from 735 at 37 C. They concluded that 30 C is more selective for *Aerobacter* and *Klebsiella* species whereas 37 C is more selective for *E. coli*.

Geldreich, et al. (5) indicate that there are 12 common coliform IMViC types of which 1 and 2 are *E. coli* and are of fecal origin. These are designated + + - - and - + - -, respectively, in the IMViC series. The Eijkman test for production of acid and gas in MacConkey's broth at 44 C is used for detecting *E. coli* type 1 which reacts + + - - to the IMViC series (2, 6).

Results of previous research attempts may have been influenced by the type of sample selected. Some workers examined water (3, 9) whereas others used milk (7, 8).

MATERIALS AND METHODS

Samples

Samples of Grade A raw milk were collected at the pasteurization plant or the producing farm. Samples originated from the University of Missouri Holstein-Jersey and Foremost Guernsey herds, bulk deliveries from Kansas City, Missouri and from selected farms in the Columbia, Missouri milkshed.

Pasteurized milk samples were taken from University cafeteria dispensers and from retail stores. Samples were held at 4 C and plated within 8 hr of collection.

Examination of raw and pasteurized samples

Platings, in accordance with *Standard Methods for the Examination of Dairy Products (1)*, were made at 1:1 and 1:10 dilutions in duplicate using desoxycholate lactose medium. One set of plates was placed at each test temperature.

After counting, typical colonies were picked from plates incubated at both temperatures for 17 samples of pasteurized milk and 26 samples of raw milk. Colonies were placed in lactose broth and incubated at the temperature at which they grew. Tubes were examined for gas production after 24 hr. Cultures in tubes showing no gas were discarded. Cultures of Gram-negative bacilli from tubes showing gas production were subjected to the series of IMViC tests (2).

Study of six isolated strains

Two sets of lactose broth tubes were inoculated with each of six strains which represented the different IMViC reaction patterns observed. One set was incubated at 32 C and the other at 37 C for 24 hr. These were then plated in desoxycholate lactose agar at dilutions to produce 15 to 150 colonies per plate and incubated for 24 hr at the temperature of previous incubation.

To eliminate the possibility that temperature of culturing in the broth might have influenced the counts in the previous experiment, each of the six strains was inoculated into a single tube of lactose broth and incubated 24 hr at 37 C before plating and incubating at the two test temperatures.

Counts from each of these experiments were converted to logarithms, and tests were performed to determine whether there were statistically significant differences between the means (4).

RESULTS AND DISCUSSION

Pasteurized milk

Coliform count comparisons were made on 190 samples of pasteurized milk. A distribution of counts

¹Contribution from the University of Missouri Experiment Station. Journal Series Number 5562.

is shown in Table 1. No colonies grew at either temperature on plates made from 48 samples. Colonies were more numerous for 62 samples incubated at 32 C and for 52 samples incubated at 37 C. Counts were equal for 28 samples. Logarithmic mean counts differed by only .0014 in favor of the 32 C temperature. Samples which produced no growth were not included in the average. These data indicate that the lower temperature is at least as satisfactory as the higher from the standpoint of numbers of coliforms detected.

TABLE 1. DISTRIBUTION OF COLIFORM COUNTS OF PASTEURIZED MILK SAMPLES INCUBATED AT 32 C AND 37 C

Coliforms/ml	Number of samples within class	
	at 32 C	at 37 C
Less than 1	68	67
1 to 10	97	101
11 to 100	22	19
More than 100	3	3
	190	190

Twelve coliform types were cited by Geldreich, et al. (5), and five of these types were isolated from the pasteurized samples (Table 2). The IMViC reactions were + + - -, - + - -, - - + +, - + + +, and - + - +. These were found among 34 isolates equally divided between the two temperatures, one colony having been picked from each of 17 pairs of plates. Three cultures produced no gas, two from 32 C and one from 37 C plates.

TABLE 2. COLIFORM/ML OF PASTEURIZED MILK AND TYPES ISOLATED FROM PLATES INCUBATED AT 32 C AND 37 C.

Sample	IMViC Reaction		IMViC Reaction	
	Coliforms/ml		Coliforms/ml	
	(32 C)		(37 C)	
1	3	- + + +	3	- + - +
2	11	- + + +	9	- + - +
3	21	- + + +	15	+ + - -
4	5	- + + +	9	+ + - -
5	23	- + + +	20	- + + +
6	136	- + + +	104	- + + +
7	9	- + + +	9	- + + +
8	20	- + + +	14	- + - +
9	30	- + + +	26	- - + +
10	11	+ + - -	14	+ + - -
11	7	+ + - -	1	+ + - -
12	3	+ + - -	3	+ + - -
13	13	- - + +	19	- + - +
14	3	- - + +	2	+ - - -
15	2	- + - -	1	- + - -
16	1	*	2	- - + +
17	2	*	2	*

*No gas produced in lactose broth; therefore, no IMViC test made.

TABLE 3. DISTRIBUTION AND MEANS OF COLIFORM COUNTS OF RAW MILK SAMPLES INCUBATED AT 32 C AND 37 C.

Coliforms/ml	Number of Samples	Mean Counts at 32 C	Mean Counts at 37 C
Less than 10	26	*	*
10 to 100	59	30	32
110 to 1000	21	434	439
More than 1000	7	4380	3400

*Not applicable

Seven pairs of plates produced organisms with the same IMViC reactions. However, nine were not the same. The type predominating reacted - + + + to the test series. There were 11 of these cultured. Three *E. coli* cultures were picked from 32 C plates and five from 37 C plates.

Raw milk

Coliform count comparisons were made on 113 samples of raw milk. No colonies grew at either temperature on plates of 1:10 dilutions of 26 samples. The 32 C temperature produced 37 higher counts, whereas 30 were higher when plates were incubated at 37 C. Counts were equal for 46 samples. The arithmetic mean counts shown in Table 3 were essentially the same for the two temperatures with the exception of the "more than 1,000" classification. However, these means were greatly influenced by two extremely high counts at 32 C. These data verify those from the pasteurized milk experiment with respect to the positive suitability of 32 C incubation.

It is interesting that 75% of the raw samples produced coliform counts of 100 or less per milliliter.

Six of the 12 coliform types, previously mentioned, were isolated from 52 colonies picked from duplicate plates of raw milk held at the two temperatures (Table 4). Five of these were the same types as isolated from the pasteurized samples. The additional type reacted + + - + to the IMViC test. Thirty-two isolates gave the IMViC reaction of - + + +. The same strain predominated in the pasteurized samples.

Twice as many isolates from raw milk grown at 32 C failed to produce gas as those grown at 37 C, 6 vs. 3. However, the numbers are probably too small to imply significance. Logarithmic mean counts differed only by 0.1048 in favor of the lower temperature.

Study of six isolated strains

When the strains representing the 6 IMViC test patterns were grown out at 32 C and 37 C in lactose broth, five of the six produced higher counts at the lower temperature. However, the average arithmetic mean difference was only 7 colonies per plate at dilutions which produced 15 to 150 colonies per

TABLE 4. COLIFORMS/ML OF RAW MILK AND TYPES ISOLATED FROM PLATES INCUBATED AT 32 C AND 37 C.

Sample	32 C		37 C	
	Coliforms/ml	IMViC Reaction	Coliforms/ml	IMViC Reaction
1	70	- + + +	70	+ + - -
2	70	- + + +	60	- + + +
3	90	- + + +	40	- + + +
4	40	- + + +	30	- + + +
5	670	- + + +	860	- + + +
6	66	- + + +	50	- + + +
7	70	- + + +	70	- + + +
8	2560	- + + +	2624	*
9	500	- + + +	500	- + + +
10	126	- + + +	32	- + + +
11	38	- + + +	40	- + + +
12	3	- + + +	3	- + + +
13	50	- + + +	52	+ + - -
14	11	- + + +	10	+ + - -
15	5688	- + + +	5000	- + + +
16	6312	- + + +	7232	- + + +
17	49	- - + +	45	- + + +
18	20	- + - +	10	- - + +
19	10	+ + - -	0	**
20	1	+ + - +	0	**
21	9	*	9	- + + +
22	10	*	10	- + + +
23	364	*	532	- + + +
24	2	*	1	- + + -
25	2015	*	2275	*
26	6500	*	2340	*

*No gas produced in lactose broth; therefore, no IMViC test made.

**No test possible.

plate, and logarithmic expression of the counts produced an average difference of only 0.088. A "t" test for differences between the logarithmic means failed to show a significant difference between the counts obtained by the two methods.

When the same six strains were grown out in lactose broth at 37 C, plated in duplicate and incubat-

ed at both 32 C and 37 C, four of the six strains produced more colonies at 32 C. Again, the mean differences were small (arithmetic mean difference = 7; logarithmic mean difference = 0.082), and the "t" test for difference between the logarithmic means failed to show significance.

These results indicate that incubation at 32 C produces counts of coliform bacteria from milk which are at least as high as those produced when 37 C is used. Only 6 of 12 common types (as determined by IMViC reaction) were tested, but both *E. coli* (14% of isolates) and *A. aerogenes* (7% of isolates) were included. The isolate most frequently encountered (IMViC reaction - + + +) was present in at least 33% of the samples.

REFERENCES

1. American Public Health Association. 1967. Standard Methods for the Examination of Dairy Products. 12th Ed. American Public Health Assoc., New York.
2. American Public Health Association. 1955. Standard Methods for the Examination of Water, Sewage and Industrial Wastes. 10th Ed., American Public Health Assoc., New York. pp. 391-393.
3. Boniece, J. R., and W. L. Mallman. 1950. The optimum incubation temperature for the primary isolation of coliform organisms. J. Am. Water Works Ass. 42:155.
4. Freund, J. E. 1952. Modern Elementary Statistics. Prentice-Hall, Inc. Englewood Cliffs, N. J.
5. Geldreich, E. E., H. F. Clark, P. W. Kabler, C. B. Huff, and R. H. Borner. 1958. The coliform group II reactions in EC media at 45 C. Appl. Microbiol. 5:341.
6. Harrigan, W. F., and M. E. McCance. 1966. Laboratory Methods in Microbiology. Academic Press, London., pp. 94-95.
7. Lawton, W. C. 1955. A comparison of 32 C and 35 C as incubation temperatures for the coliform count of milk and cream. J. Milk Food Technol. 18:280.
8. Murry, J. G. 1953. A comparison of 30 C and 37 C as incubation temperatures in the presumptive coli-aerogenes test for raw and pasteurized milk. Soc. Appl. Bacteriol. 16:24.
9. Thomas, S. B., P. M. Hobson, and R. G. Druce. 1959. Coli-aerogenes bacteria in farm water supplies. J. Appl. Bacteriol. 22:32.

ALIGNMENT OF INDUSTRY-ORIENTED SANITATION PROGRAM¹

FRED R. VITALE

*Continental Baking Company
Rye, N. Y.*

Everyone will agree that there are many ways to set up an effective industry sanitation program. Therefore, I will briefly mention some of these ways, and then take a detailed look at our program. It should be pointed out from the beginning that no matter what program is followed, sanitation in a plant remains the responsibility of management. The active interest, desire, and support of top management is essential. Without this support, the sanitation program is destined to fail. A plant manager can assume the sanitation responsibility, and take complete charge of the program, or he can delegate the sanitation responsibility: (a) to the engineering division, where the Plant Engineer is given complete charge of the sanitation program, (b) to the Production Department, where the Production Superintendent is given complete charge of the sanitation program, (c) to the Sanitation Department where the Plant Sanitarian, as a department head, is given complete charge of the sanitation program, or (d) to an outside sanitation "service."

MANAGEMENT SUPPORT

The management support for our sanitation program starts at the general office level, with a general office sanitation committee. The President of the company is the chairman of the committee, and the Director of Sanitation is co-chairman. Every general office department head is an active member of this committee. This same basic organization pattern is followed for the regional and plant sanitation committees.

The general office sanitation committee's function is to establish company sanitation policy, provide direction and check performance. Through the Director of Sanitation's office, the basic program is carried forward to the plants through the assistance of the field Sanitation Supervisors. In addition, each department head works through his regional counterpart on common sanitation problems. The regional sanitation committee's function is to set up a sound regional follow-up program for sanitation, to ensure that all plants in the region are maintained at the highest level of *continuous sanitation* by following established company policy. The plant committee's

function is to carry out the sanitation program as established by company policy, and maintain the plant at the highest level of *continuous sanitation*.

PLANT SANITARIAN

In all of our plants, the responsibility of sanitation is delegated to a Plant Sanitarian who, as department head, works directly for, and answers to, the Plant Manager. I refer to our plant sanitation program as *continuous sanitation*. By this we mean the continuous preservation of clean surroundings, created by the subconscious natural or instilled quality within the individual, which demands orderliness and cleanliness.

THE SANITATION PROGRAM

The first step in our sanitation program begins with an orientation program for all new employees, which consists of a meeting with each department head. During the meeting with the Plant Sanitarian, our sanitation program is reviewed, the importance of personal cleanliness and sanitary working habits is outlined, and each individual's contribution to the sanitation effort, and the importance of cooperation from all employees, is stressed.

The next step in our sanitation program is training. Basically, this consists of on-the-job training and home study, through the use of a series of sanitation bulletins. This program is followed in training Sanitarians and Sanitors, and with slight modifications is used to give sanitation training to Managers, Sales Managers, Superintendents, Engineers and other supervisors. Visual aids, such as film strips, hand-out flyers, and bulletin board posters are also used to impart sanitation training to the rank and file. I briefly mentioned earlier, that each plant has a sanitation committee. This committee consists of each plant department head.

A brief description of the way each department cooperates to maintain a clean and orderly bakery follows: (a) the Manager gives the sanitation program proper backing, and allows sufficient budget, (b) the Sanitarian organizes and gives direction and guidance, and follows through on all sanitation activities in the plant, (c) the Shop Superintendents develop and instill clean working conditions and personal habits in their people, (d) the Plant Engineer installs sanitation aids, and maintains the physical condition

¹Presented at the 55th Annual Meeting of the International Association of Milk, Food, and Environmental Sanitarians, Inc., St. Louis, Missouri, August 18-22, 1968.

of the equipment and buildings, (e) the Garage Superintendent maintains clean trucks, both inside and out, and a clean and orderly shop, (f) the Sales Supervisors instruct salesmen in truck, garage, personal, and sales room cleanliness, (g) the Office Manager instructs his people in clean work and personal habits regarding lunch room, locker rooms, and storage rooms; he also helps the sanitarian with proper accounting in order to control costs, (h) the Receiving Clerk inspects incoming ingredients and maintains proper storage and rotation of all stock, (i) the Personnel Manager recruits qualified personnel, and assists in our training program, and (j) the Shipping Room Supervisor instructs his people in clean working habits, and maintains a shipping schedule to minimize congestion in the plant.

INSPECTION

The committee holds a weekly meeting, after making a joint brief inspection of a preassigned area of the plant. Each individual makes notes of his inspection, and these notes are summarized for follow-up by the department head responsible. The plant is divided into 7 areas, so that the entire plant is covered every 2 months. On the eighth week, these inspections are reviewed and the plant sanitation committee makes a sanitation rating of the plant. The rating system used is similar to that used by the American Institute of Baking (AIB), in their inspection of our plants. These inspections will be discussed in more detail later. We feel that the committee meetings improve the cooperation between departments, and further trains the supervisors by making them aware of problems in other departments. As mentioned earlier, the responsibility for sanitation in our plants is delegated to the Plant Sanitarian. Rather than discuss in detail the many duties of the sanitarian, I will limit my comments to the key points of the program. I briefly mentioned the inspections made by the plant sanitation committee. Other inspections made by the sanitarian include a daily eye-level inspection of the entire plant. Infractions noted on this inspection are listed in the sanitarian's daily log.

This report is used by the sanitarian to keep the manager informed of the every day conditions during their daily contact period. In addition to the plant sanitation committee's inspection, and the daily eye-level inspection, the sanitarian also makes a daily comprehensive inspection of an area of the plant. In this way, he is acting as a "resident" AIB inspector, thoroughly inspecting the entire plant every two months. The infractions noted on these inspections are recorded, and the respective department heads are informed for proper follow-up. These infractions are also used by the plant sanitation committee in

assigning the sanitation rating for the plant for the respective two month period.

The rating system is an arbitrary method of expressing the sanitation level existing within a plant (superior—900 to 1000 points, excellent—800 to 899, satisfactory—725 to 799, passable—650 to 724, unsatisfactory—below 650). The rating is determined by appraising 5 sanitation categories, each of which has equal weight of 200 points. (Sanitation categories: (a) adequacy of sanitation program, 200 points; (b) pest control, 200 points; (c) operational methods and personnel practices, 200 points; (d) maintenance for sanitation, 200 points; and (e) cleaning methods, 200 points). It has been our experience that the infractions noted in these inspections generally follow a 5%, 5%, 30%, 30%, and 30% pattern, respectively, for these categories. The infractions noted, and their severity, take away from the numerical score for that category. The plant rating is determined by using the total point score of all categories.

If a situation exists where there is a serious breakdown in the sanitation program, whereby the finished product is likely to become contaminated, the plant may be assigned an unsatisfactory rating. If this should happen during an AIB inspection, a "re-inspection" of the plant is made generally within 90 days.

The basic rating system is followed by the AIB field sanitarians that inspect our plants. I might add that the AIB inspections are an integral part of our sanitation program, and these unannounced inspections are made more or less on a yearly basis. These inspections give us an independent unbiased audit of the plant's sanitation, and they provide us with the information to determine if the individual plant's program is in compliance with company standards. The AIB inspection also serves as an educational opportunity for the plant personnel to take advantage of the field sanitarians' experience and training in finding practical answers to existing problems, and advise regarding potential problems.

The reports of each plant's AIB inspections are sent to the general office. Each report is reviewed by the Director of Sanitation, who makes appropriate comments, and forwards his comments (with copies of this report) to the regional Vice-President, then forwards copies of the inspection to the Plant Manager, asking him to make a detailed report, within 30 days, of the corrective action taken on each item as listed to the Director of Sanitation. As the AIB reports are circulated to members of the general office sanitation committee, the various department heads work through their regional counterparts on problems in their area of responsibility.

Other inspections of our plants are conducted by the Food and Drug Administration, military, state,

and local authorities. The sanitarian must be thoroughly familiar with company policy regarding these inspections, and he is one of the key people who must accompany these inspectors in our plants.

LABOR COSTS IN SANITATION

Since labor represents approximately 95% of the sanitation costs, it is imperative for the sanitarian to maintain maximum control of his labor costs. This control can be accomplished through proper scheduling of each sanitor's work routine, both "daily" and "periodically." The daily work schedule is a station or area schedule which is posted in the area where the man works. This schedule includes the working hours, work to be done, and the method of cleaning.

A sanitor's duties, other than daily or periodical work, is assigned from the items noted during the various inspections, or is taken from a master work book. These duties are listed on the sanitor's special assignment sheet.

The master work book is a listing of all cleaning jobs that are not done on a daily basis. These jobs include both equipment and structural cleaning. The cleaning frequency, which may vary weekly or yearly or longer is also listed. As each job is completed, the date is noted in the appropriate space.

As our plants have become larger, the need to prevent wasting of valuable time by the sanitors, in making frequent trips to and from a central stock room, became obvious. We are now using individual sanitor carts in many of our plants. They are metal carts on wheels, provided with a lock and key, and each cart is numbered and assigned to a sanitor. Each cart is fully equipped with almost all of the tools and supplies needed to do the various cleaning jobs.

RECEIVING GOODS

In many plants, the responsibility for receiving is under the sanitarian. In other operations, particularly our larger ones, this responsibility is given to a receiving clerk who is a department head. In either case, the control of foreign material is a very important job of the bakery sanitarian, and this control must begin with the receipt of ingredients. A visual examination of all incoming ingredients is made immediately after the delivery vehicle is opened. This examination of the outside of bags or cartons is for physical damage, and foreign substances such as grease spots or stains, as well as for evidence of insects and rodents. An ultra-violet, or so-called "black light," is used to pin-point evidence of rodent contamination. Rejection of shipments is frequently made, based on the findings of these examinations.

All finely ground materials are examined upon re-

ceipt by sifting samples through 30-mesh screen. Four bags from a carload shipment are selected at random for sifting, and if any foreign material is found (such as a live or dead insect), 6 additional bags are sifted to determine the degree of contamination, and whether the lot should be considered for rejection. A record is kept of each lot examined. Foreign material may also reach the ingredients after their arrival in the plants. Therefore, our checkpoints for foreign material control must include the ingredients while in storage, and at the point of use in the shops. The last line of defense in foreign material control must be production practices, which prevent the incorporation of foreign material in the finished product. This requires departmental cooperation in the development of good working habits.

CHECK ON "TAILINGS"

The sifter of the plant flour handling system also contains a 30-mesh screen, and the "tailings" obtained are checked on a daily basis. A record is kept of these findings, and are reported weekly to the regional and general offices. Any adverse findings are brought to the attention of the purchasing department, and the flour mill that is involved.

BULK HANDLING

With the increase in bulk handling of more dry and liquid ingredients, increased sanitation responsibility in this area becomes a necessity. The use of common carriers, inspection of the delivery vehicles, use of filters, handling of the product in the plants, and the cleaning of the bulk handling equipment all require detailed study to avoid potential problems of product contamination and product quality deterioration. The use of bulk ingredients has also increased the need for inspection of these suppliers' manufacturing facilities.

TESTS ON INGREDIENTS

Selected ingredients are routinely sampled and sent to our research laboratories for analysis. In cooperation with our laboratories, we make bacteriological surveys of our operations, and routinely use petri plates to make surveys of the incidence of mold spores in various areas throughout the plants. The use of hand sanitizing dip stations, and the sanitizing of equipment is a prime requisite for bacterial control, and these procedures have become an integral part of our program.

PEST CONTROL

We utilize a self-controlled program for pest control. Therefore, our sanitarians must be thoroughly

familiar with various types of cereal insects, their life cycles, habits, and other characteristics in order to understand the control measures that should be used to avoid infestation problems. Other species of insects that are of primary concern include ants, flies, and roaches. While we stress that 80% of the job of insect control is the cleanliness or housekeeping effort, there will always be the casual insect invader. Therefore, use of insecticides is necessary. The sanitarian must also be thoroughly familiar with the composition, application, precaution, and effectiveness of all company-approved insecticides.

A necessary part of our pest control program is the control of rodents. The sanitarian must be thoroughly familiar with the habits and characteristics of both rats and mice to guide him in establishing an effective control program. This program must include rodent-proofing the building, eliminating outside harborages or conditions conducive to rodents, as well as keeping traps set at all times in strategic areas.

Birds are also included in our pest control program. Such species as pigeons, sparrows, and starlings are most frequently encountered. As is true with insect and rodent control, sanitation is of prime importance in bird control. Sanitation must include their exclusion from food, roosting, resting, and nesting. Revolving lights and ultrasonic devices have not been very effective for bird control and our knowledge of chemical control is limited.

BISSC

Nearly everyone is familiar with the baking industry sanitation standards committee, commonly known as BISSC. This committee was founded near-

ly 20 years ago to meet the serious sanitation problems caused by uncleanable bakery equipment, inadequate consideration of sanitation requirements in the design of new equipment, and the use of unsuitable materials in bakery food processing units. Our company has been represented on, and has taken an active part in, the functions of this committee from the very beginning. It is company policy, in the purchase of new equipment, to insist on BISSC certification whenever possible. This also holds true in the manufacture and/or alteration of equipment in our plants. The sanitarian naturally is consulted in these matters.

AGENCIES AND DEPOTS

While I have been discussing our program primarily as it is carried out at the plant level, we also have to be concerned about our "agencies" or distribution depots. The agencies follow our same basic sanitation program under the direction of the Agency Manager. Semi-annual sanitation inspections of the agencies are conducted by the Sanitarian, Engineer and/or Manager from the plant responsible for the agency.

As I stated at the beginning of this paper, responsibility for sanitation in the plant is that of the *manager*. It is frequently stated in our company that, "a plant is as clean as a manager wants it to be." While I feel that we have an excellent basic sanitation program, it is necessary to have the desire of each manager, the department heads, and every employee to make the program work with maximum efficiency to produce the highest quality products in kitchen clean surroundings at a profit.

SOME RECENT VIEWS ON RECONSTITUTABILITY AND KEEPING QUALITY OF MILK POWDER

SAT PARKASH¹

Department of Food Science
University of Alberta,
Edmonton, Canada.

(Received for publication April 22, 1968)

The chemical and physical properties of milk powder are influenced by several factors, including its composition, method of manufacture, storage conditions, and the reconstitution procedures (18). The predominant use of milk powder has been in human nutrition. The complex nature of milk powder poses several problems for its evaluation. For example, the physical state of casein is a factor limiting the rate of dispersion of dried milk (4), and in the manufacture of milk powder, if condensing of preheated milk is omitted, wettability is poor but any additional heat treatment after condensing the milk produces an adverse effect. With the introduction of a recombination process, which involves reconstitution of skim milk powder and emulsification of milk fat into skim milk, the study of the physico-chemical aspects of milk powder is becoming of greater interest. This article deals with reconstitutability and keeping quality of milk powder and their relation to dairy problems.

Of the various processes that are used to dry milk, spray drying is by far the most popular. Lesser quantities of milk and other dairy products are roller dried.

RECONSTITUTABILITY

In recent years a considerable emphasis has been placed on the problem of manufacturing very readily soluble skim milk powders, often called "instant" powders. Since 1954, the production of instant nonfat dry milk has increased rapidly. Practically all nonfat dry milk for home use is now instantized.

Instant nonfat dry milk may be made by any one of the three general methods viz. (a) single-pass instant, (b) agglomerated instant, and (c) puff instant. In most commercial manufacturing methods, agglomeration of powder particles is accompanied by surface wetting, clumping, then redrying. Among the factors affecting instantizing (or agglomeration) moisture content and particle size are quite important. A minimum of fine particles, less than 20μ in diameter

is desired with the preferred particle range of 25 to 50μ .

The problems in manufacturing a satisfactory instant dry whole milk, have been more difficult largely because of the presence of milk fat in the system. Dispersibility of dry whole milk (26% fat) is the lowest (31.9 g) compared to products with lower fat contents (21). There is presently some commercial production of foamed spray dried nonfat dry milk as well as dry whole milk. The foam-dried whole milk although little different in wettability from the normal spray dried particles, disintegrates rapidly once contacted by water.

A perusal of the literature shows that increasing attention is being paid to the reconstitution of dried milk (18), although the reconstitutability of milk powder is a poorly defined and complicated concept. The subject has been quite extensively reviewed by Coulter and Jenness (12). The task of describing a method which includes all properties and definitions involved and which applies to different local conditions therefore, is difficult.

The first stage in reconstitution after the initial contact of water is the wetting of particle surfaces (16, 20), which is followed by water absorption and swelling of proteins and solution of soluble constituents (7, 22). However, smooth progress of the reconstitution process and properties of the product obtained depend upon manufacturing and storage conditions, which affect the nature of the powder particle.

Part of the difficulty of rapidly reconstituting milk powders in water lies in the number of different reactions which occur when milk powder and water are brought into contact with each other. Wettability, dispersibility, and solubility appear to cover most of the reactions involved and are suggested as a basis for discussion by Abbot and Waite (2). These workers define them as:

Wettability: the rate at which a mass of milk powder is penetrated by, or sinks into, quiescent water.

Dispersibility: the degree of separation of wetted powder particles in water.

Solubility: the degree to which the constituents

¹Present Address: Research Council of Alberta, Edmonton, Canada.

of milk powder can be brought into solution or stable suspensions.

Experiments of Abbot and Waite (2) demonstrate that in characterizing the reconstitutability of milk powders, particularly in relation to domestic use of "instant" milk powders, the test method should take into account all three characteristics of wettability, dispersibility, and solubility rather than of any single characteristic. However, for day-to-day factory control, a wettability test coupled with a solubility measurement, both providing results quickly, would provide useful information. The surface of the individual particles of skim milk powder is readily wettable. However, wettability decreases with an increase in the fat content (21, 24).

Rate of dispersion of milk powder during reconstitution is also considered as one of the factors by which a powder is judged. The first stage of the dispersion of any powdered material is the wetting of the solid particles by the solvent. Milk powders have a very wide range of wettability. Some samples sink readily upon coming in contact with the solvent, whereas others remain floating on the surface. Several methods for the estimation of wettability are already in use (5, 6). Muers and House (22) have proposed a simple method for comparing the wettability of "instant" spray dried separated milk powders. According to this method a layer of powder, spread evenly over a defined area of a piece of easily permeable cloth, is caused to float on the almost quiescent surface of water rising through the cloth. The time taken for the sample to be wetted is recorded. Wetting times vary from a few seconds for good "instant" powders, to several minutes for ordinary spray dried powders. Muers and House (22) have also demonstrated that particle size is the most important factor controlling ease of wetting. As rightly pointed out by Coulter and Jenness (12) the situation of dispersibility with dry whole milk is somewhat confused. Rapid cooling of the powder and coating with a surface active material (e.g. lecithin) are suggested for improved wettability (24, 26, 31).

According to Samkammer (25) wettability of whole milk powder depends upon the amount of free fat only to a certain degree, and solubility of "instant" powders is somewhat decreased after extracting the fat. The reason for this is supposed to be an impairment of the capillary active effect of the spaces between the agglomerated particles. Ultimate solution of any powder, is dependent upon the extent of casein destabilization. Reduction of the hydrophilic properties of the milk protein has been claimed by Kennedy and Spence (15) to improve the reconstitutability of dry milk.

Numerous methods for determination of the solu-

bility of milk powder have been devised. Broadly they may be divided into two groups: (a) those which may claim to a more exact determination and (b) those which give a more or less conjectural figure. The more exact methods are too elaborate to be of any practical importance to industry. A simple and fairly accurate method has been proposed by the American Dry Milk Institute (8). Both Falkenhahn (13) and Cone and Ashworth (9) also find a certain correlation between the more exact methods and the American Dry Milk Institute (ADMI) method. Steen (27) is of the opinion that better results for the solubility of milk powder can be obtained if a more gentle mixing is used in the ADMI method.

KEEPING QUALITY

The keeping quality of milk powder is limited by bacteriological and chemical processes. Decomposition of milk solids by bacteriological transformations can be effectively checked by reduction of moisture contents to a level below the minimum required for their growth (14) because the stability of dry milk during storage is critically affected by the moisture content and storage temperature. High moisture levels, resulting from inadequate dehydration or reabsorption of atmospheric moisture promote insolubilization at relatively mild storage temperatures. The rate of solubility loss is a function of both concentration and temperature (10).

A number of other significant changes also occur in high moisture milk powder in addition to loss of solubility. For example, (a) the lactose is gradually bound by the protein, (b) the pH decreases steadily, and (c) characteristic changes associated with the Maillard reaction between sugars and amino nitrogen become apparent including development of brown discoloration and production of carbon dioxide (30). The loss of protein solubility in dry milk is generally attributed to the sugar-protein interaction. Changes in the stability of the caseinate-phosphate complex are also responsible for the loss of solubility. According to Manus and Ashworth (19), the solubility of spray-dried powder is unaffected by preheat treatments of fluid milk that cause serum protein denaturation. The influence that forewarming of milk exerts on stability of the evaporated product to sterilization temperatures indicates that proteins of milk interact in a way which interferes with and reduces heat denaturation of the proteins when they are subsequently given a high temperature treatment. Heat-induced reactions, which have been shown to increase the stability of milk proteins include a casein- β lactoglobulin interaction and protein-lactose binding. Addition of stabilizers is used mainly in commercial practice to ensure a fluid finished prod-

uct. Stabilizers are soluble salts whose anions complex or precipitate calcium, and as the casein in heated milk is more sensitive to calcium than it is in unheated milk, stabilizers are considered to exert their protecting influence by removing calcium which might otherwise form an interpolymer link between altered casein molecules causing them to aggregate and precipitate.

According to King (17) the dry milk particle has a primary physical structure comprised of the milk solids in which is dispersed the moisture and air cells. The physical mass of the particle (nonfat dry milk and dry whole milk) is dominated by lactose presumably in which the proteins, fat, and minerals are more or less dispersed. Lactose in dry milk may be in the amorphous or glass (non crystalline) form and as α monohydrate crystals and β anhydride crystals. In the amorphous state lactose is very hygroscopic and as sorption occurs, the lactose becomes sticky and this initiates adherence of the milk particles to each other. With sufficient moisture and time a solid mass is formed through continued crystallization of lactose. The instantizing process for producing readily soluble powder is somewhat similar. The surfaces of milk powder particles are humidified or partially dried so as to facilitate partial crystallization before the particles are redried (23). This produces a clustering of the particles in loose, spongy aggregates which are readily dispersible in water. Careful control of conditions of rehydrating, holding to allow agglomeration, and redrying are very important to preserve the solubility of the powder. Unfortunately little technical information is available on the process.

Spray process dry whole milk is normally prepared from milk which has been preheated to a temperature sufficient to denature essentially all of the whey proteins. The effect of heat treatment of the fluid milk in stabilizing against oxidation of the fat in the dry product has long been recognized. Assuming average conditions of milk quality and processing, oxidation off flavors become noticeable in about three months when dry whole milk is held at 70 to 75 F (air packed). Among the many factors influencing the rate of milk fat oxidation, metallic contamination from copper and iron is one of the most important. Attempts have been made by several workers to use antioxidants to avoid high heat treatment of the milk but, unfortunately, none of the antioxidant has been claimed to be more effective than heating the fluid milk (1, 28).

Milk powder in hermetically sealed packings is safe against reabsorption of moisture under unfavorable conditions and therefore, any deterioration of the quality of the powder is seldom of a bacteriological nature. The chemical processes in whole milk

powder are very difficult to stop completely. The most common defect in whole milk powder is the tallowy flavor caused by the oxidation of the butter (14). Aceto et al. (3) have reported on some storage aspects of continuous vacuum foam dried whole milk made, handled, and packaged with virtually no contact with oxygen. Difficulties encountered in producing low oxygen content packs apparently relate to milk powder particle structure (29).

Keeping quality of milk powder has become increasingly important in recent years particularly in view of shipping dry milk to developing nations of the world having widely ranging weather conditions and lack of other facilities.

Browning as such is not a primary problem in dry milks. Milks dried to moisture levels below 5% show essentially no change in color even during a 2-year storage at 37 C. However, because of the very hygroscopic nature of milk powder, initial satisfactory moisture levels are no guarantee against browning. The subjects of browning and related changes in dry milk systems have been reviewed quite extensively by Coulter et al. (11).

ACKNOWLEDGEMENT

The interest of Professor Robert Jenness, Department of Biochemistry, University of Minnesota and of Dr. J. M. deMan, Department of Food Science, University of Guelph in this article is gratefully acknowledged.

REFERENCES

1. Abbot, J., and R. Waite. 1962. The effect of antioxidants on the keeping quality of whole milk powder. I. Flavones, gallates, butylhydroxyanisole and nordihydroguaiaretic acid. *J. Dairy Res.* 29:55.
2. Abbot, J., and R. Waite. 1966. Characterization of the ease of reconstitution of milk powders; nomenclature and tests. 17th Intern. Dairy Congr. E:3,203.
3. Aceto, N. C., J. C. Craig, Jr., R. K. Eskew, and F. B. Talley. 1966. Storage aspects of continuous vacuum foam-dried whole milk. 17th Intern. Dairy Congr. E:3,189.
4. Ashworth, U. S., and H. A. Bendixen. 1947. Factors affecting the ease of reconstitution of milk powders. *J. Dairy Sci.* 30:528.
5. Ashworth, U. S., and H. Gunthardt. 1954. The wettability method for powdered milk. *J. Dairy Sci.* 37:863.
6. Baker, B. E., and E. Bertok. 1959. Studies on milk powders. II. A method for the estimation of the wettability of milk powders. *J. Dairy Sci.* 42:869.
7. Bockian, A. H., G. F. Stewart, and A. L. Tappel. 1957. Factors affecting the dispersibility of "instantly dissolving" dry milks. *Food Res.* 22:69.
8. Bull. American Dry Milk Institute. 1947. The grading of non-fat dry milk solids. No. 13.
9. Cone, T. J., and U. S. Ashworth. 1947. A new quantitative method for determining the solubility of milk powders. *J. Dairy Sci.* 30:463.
10. Coulter, S. T., R. Jenness, and L. K. Crowe. 1948. Some changes in dry whole milk during storage. *J. Dairy Sci.* 31:986.

11. Coulter, S. T., R. Jenness, and W. F. Geddes. 1951. Physical and chemical aspects of the production, storage and utility of dry milk products. *Advances in Food Res.* 3:45.
12. Coulter, S. T., and R. Jenness. 1964. Dry milk products. Chap. 20, *Food Dehydration-Vol. II: Process and Products* edited by W. B. Van Arsdel and M. J. Copley. AVI Pub. Co. Westport, Conn. pp. 591.
13. Falkenhahn, W. V. 1958. The correlation between A.D.M.I. solubility indices and percentage solubilities of spray dried milks. *Aust. J. Dairy Technol.* 1:13.
14. Julskjaer, O. 1962. The influence of nitrogen packing on the keeping qualities of whole milk powder of different storage temperatures. 16th Intern. Dairy Congr. V:2,983.
15. Kennedy, J. G., and E. R. Spence. 1960. Easily reconstituted milk powder. U. S. Pat. 2,928,742. Mar. 15.
16. King, N. 1958. The reconstitutability of milk powder. *Milchwissenschaft.* 13:259.
17. King, N. 1965. The physical structure of dried milk. *Dairy Sci. Abstr.* 27:91.
18. King, N. 1966. Dispersibility and reconstitutability of dried milk. *Dairy Sci. Abstr.* 28:105.
19. Manus, L. J., and U. S. Ashworth. 1948. The keeping quality, solubility and density of powdered whole milk in relation to some variations in the manufacturing process. II. Solubility and density. *J. Dairy Sci.* 31:935.
20. Mohr, W. 1960. Suggestions regarding the requirements of instant whole milk powder. *Milchwissenschaft* 15:215.
21. Mori, K., and T. I. Hedrick. 1965. Some properties of instantized dry milk. *J. Dairy Sci.* 48:253.
22. Muers, M. M., and M. A. House. 1962. A simple method for comparing the wettability of "instant" spray dried separated milk powders. 16th Intern. Dairy Congr. V:1,923.
23. Peebles, D. D. 1956. Development of instant milk. *Food Technol.* 10:64.
24. Pyne, C. H. 1961. Reconstitution of dry milk products. Ph. D. Thesis. Dept. of Dairy Industries, Univ. of Minnesota.
25. Samkammer, E. 1966. Studies on the judgement of properties of instant milk powders '17th Intern. Dairy Congr. E:3,209.
26. Sjollema, A. 1960. Process for modifying powdered milk products. U. S. Pat. 2,953,458, Sept. 20.
27. Steen K. 1962. The solubility of milk powder and its determination. 16th Intern. Dairy Congr. V:1,959.
28. Tamsma, A., T. J. Mucha, and M. J. Pallansch. 1963. Factors related to the flavor stability during storage of foam-dried whole milk. III. Effect of antioxidants. *J. Dairy Sci.* 46:114.
29. Tamsma, A., F. E. Kurtz, and M. J. Pallansch. 1967. Effect of oxygen removal technique on flavor stability of low-heat foam spray dried whole milk. *J. Dairy Sci.* 50:1562.
30. Tumerman, L., and B. H. Webb. 1965. Coagulation of milk and protein denaturation. In: B. H. Webb and A. H. Johnson, eds., *Fundamentals of Dairy Chemistry*. AVI Publishing Co., Inc., Westport, Conn.
31. Winder, W. C., and D. H. Bullock. 1961. Process of modifying dried milk. U. S. Pat. 3,008,830, Nov. 14.

AMENDMENT TO 3-A SANITARY STANDARDS FOR MULTIPLE-USE PLASTIC MATERIALS USED AS PRODUCT CONTACT SURFACES FOR DAIRY EQUIPMENT

Serial #2003

Formulated by

International Association of Milk, Food and Environmental Sanitarians

United States Public Health Service

The Dairy Industry Committee

The "3-A Sanitary Standards for Multiple-Use Plastic Materials Used as Product Contact Surfaces for Dairy Equipment, Serial #2000," are hereby amended as indicated in the following:

Section I. Standards for Acceptability, Sub-paragraph (2):

Add the following material to the list of Generic Classes of Plastics:

Reinforced Epoxy, molded,	.20	.25	.35
natural (no color added),			
and black.			

This amendment shall become effective Aug. 28, 1969.

**AMENDMENT TO
3-A ACCEPTED PRACTICES FOR THE
SANITARY CONSTRUCTION, INSTALLATION,
TESTING AND OPERATION OF HIGH-TEMPERATURE
SHORT-TIME PASTEURIZERS, REVISED
(EFFECTIVE JANUARY 22, 1967)**

Formulated by

International Association of Milk, Food and Environmental Sanitarians

United States Public Health Service

The Dairy Industry Committee

The "3-A Accepted Practices for the Sanitary Construction, Installation, Testing and Operation of High-Temperature Short-Time Pasteurizers, Revised," effective January 22, 1967, are hereby amended in the sections indicated below and an additional drawing, Figure 21, is added:

Add the following to definition B.1 after the words "frozen dessert mix":

or a concentrated milk product

In the fourth line of E.5.8, replace the comma after the word "end" with a period, delete the words "and provisions" and add the following before the word "made":

When the salt conductivity test is to be used to determine holding time, provision shall be

Substitute the following for the present E.5.8.2:

E.5.8.2

When a timing electrode connection is provided at the inlet end, it shall be adjacent to and upstream from the inlet end of the holding tube.

Add the following subsections:

E.6.8

When the timing pump is to be located as provided for in F.3.2, the flow diversion device shall have an auxiliary temperature sensor-controller and a time delay relay to accomplish the requirements of F.5.2.1. (Note: The auxiliary temperature sensor-controller and/or the time delay relay do not have to be in the same case with the recorder-controller but they shall comply with the applicable provisions of this subsection, E.6).

E.6.8.1

The auxiliary temperature sensor-controller shall have a control mechanism for setting the temperature at which forward flow can occur and a means of indicating when the product temperature at the temperature sensor of the auxiliary temperature

sensor-controller is at or above the temperature at which the control mechanism is set. The means of indicating may be a pilot light or other suitable means.

E.6.8.2

The flow diversion device shall be actuated by the auxiliary temperature sensor-controller and the time delay relay as required in F.5.2.1 as well as the temperature sensor that actuates the product temperature recorder as required in E.6.2.4.

E.6.8.3

The temperature accuracy of the auxiliary temperature sensor-controller shall be that required for the recorder-controller in E.6.7.3.

E.6.8.4

The thermometric response of the auxiliary temperature sensor-controller shall be that required for the recorder-controller in E.6.7.16.

E.6.8.5

The auxiliary temperature sensor-controller and the time delay relay shall be provided with a simple means of sealing that will prevent, unless the seal is broken, the changing or manipulating of (1) the control mechanism for setting the temperature at which forward flow can occur and (2) the mechanism for setting the length of time delay.

Substitute the following for the present E.8.1:

E.8.1

Hot Products Thermometers (Required)

One hot product thermometer complying with the criteria of this section is required for all HTST pasteurizers. A second hot product thermometer

is required for HTST pasteurizers when the timing pump is located as provided for in F.3.2.

Add the following subsection:

E.9.5

When the timing pump is to be located as provided for in F.3.2, a fitting(s) for installing an indicating thermometer and the temperature sensor of the auxiliary temperature sensor-controller shall be provided in the product constant level tank outlet line between the tank outlet connection and the first connection downstream.

Add the following subsection:

E.9.6

When the timing pump is located as provided for in F.3.2, automatic means shall be provided to prevent negative pressure at the downstream side of the forward flow port of the flow diversion device during diverted flow.

The automatic means shall be one of the following or other acceptable means.

E.9.6.1

A flow diversion device incorporating two valves (one a divert valve and the other a leak escape valve) with the leak escape opening having a total effective area at least as great as the area of the forward flow opening. The leak escape opening of the leak escape valve shall be provided with a discharge line which shall discharge to either (1) the atmosphere and be protected from back siphonage of vapors or liquids or (2) the product constant level tank. In the latter case, a vacuum breaker shall be installed in the line between the leak escape valve and the product constant level tank.

E.9.6.2

An automatic shut off valve downstream from an effective vacuum breaker of sanitary construction having enough air admitting capacity to prevent negative pressure. The shut off valve must automatically assume the stop position when the air supply to the flow diversion device is interrupted causing it to assume the diverted flow position.

Substitute the following for the present F.3.1:

F.3.1

The timing pump driving motor and starter shall be interwired with all components as prescribed in F.5 and the timing pump or device, except as provided in F.3.2, shall be installed upstream of the holder.

Add the following subsection:

F.3.2

When the HTST pasteurizer is to be used to re-

pasteurize a concentrated milk product for drying in a process in which the product pressure required for drying is at least 300 pounds per square inch, the timing pump may be located downstream from the flow diversion device provided the requirements of E.6.8, F.5.2.1 and all other applicable requirements found in these practices are met. In this application the timing pump must be a high pressure pump of the plunger type.

In F.4.2, add the following between the words "fitting" and "at": , when provided,

Add the following subsection:

F.5.1.1

The temperature sensor of the auxiliary temperature sensor-controller required in E.6.8 shall be installed in the fitting described in E.9.5.

Substitute the following for the present subsection F.5.2. and add subsections F.5.2.1 and F.5.2.2.

F.5.2

Except as provided for in F.5.2.1, and F.5.2.3, the flow-diversion device shall be so inter-wired with the controller of the recorder-controller that when the product temperature at its temperature sensor is at sub-legal and legal temperature the flow diversion device will automatically assume the diverted and forward flow positions respectively.

F.5.2.1

When the timing pump is located as provided for in F.3.2, except as provided for in F.5.2.3, the controllers of recorder-controller, the auxiliary temperature sensor-controller and the time delay relay are to be so inter-wired that the flow-diversion device (1) will assume the diverted flow position when the product temperature at the temperature sensor of the recorder-controller is at sub-legal temperature and (2) will assume the forward flow position when the product temperature at both temperature sensors is at or above legal temperature for at least legal holding time. The inter-wiring shall be such that when the flow diversion device is in the forward flow position, the controller of the auxiliary temperature sensor-controller will not cause the flow diversion device to move to the diverted flow position when the temperature of the product at its temperature sensor is sub-legal.

If the flow diversion device and/or recorder-controller has a manual means of causing the flow diversion device to assume the diverted flow position, the controllers of the recorder-controller and the auxiliary temperature sensor-controller are to be so inter-wired that after the flow diversion device has assumed the diverted flow position due

to operation of the manual means, the flow diversion device will not assume the forward flow position until the product temperature at both temperature sensors is at or above legal temperature for at least legal holding time.

F.5.2.2

During circulating cleaning the flow-diversion device may assume the forward flow position or be cycled at sub-legal temperature provided the control required to do this is a programmed control that is fail safe and is inter-wired with the timing pump so that the timing pump cannot run under this condition.

Substitute the following for the present F.7.1 and F.7.1.1:

F.7.1

Indicating Thermometers—Hot Product

F.7.1.1

One thermometer shall be installed in the fitting at the outlet of the holding tube, as described in E.5.8. and E.5.8.1. When the timing pump is located as provided for in F.3.2 a second thermometer shall be installed in the fitting described in E.9.5.

Add the following subsection:

E.9.7

In a HTST pasteurizing system supplying repasteurized product to a drier with the timing pump located as provided for in F.3.2, having a potable water line connected to a product line in which the product may be under vacuum, the potable water line must be installed in conformance with local plumbing codes for water flowing into a vacuum and shall have a check valve adjacent to its connection to the product line to prevent back flow of product into the potable water line. The check valve shall be of sanitary design that complies with the criteria set forth in the "Amendment to Supplement No. 3 to the 3-A Sanitary Standards For Fittings Used On Milk And Milk Products Equipment and Used on Sanitary Lines Conducting Milk and Milk Products, Serial #0803A" and the piping between the check valve and the product line shall be of sanitary construction; that is, it shall conform to E.9.1 and F.8.1.

Add the following to subsection F.13.1:

Note: The applicable provisions of this subsection apply to timing pumps of the high pressure plunger type.

Add the following subsection:

F.19.3

In a HTST pasteurizing system supplying repas-

teurized product to a drier with the timing pump located as provided for in F.3.2, an auxiliary pump is required in order that there will be product circulation during diverted flow and to assure positive product pressure at the timing pump inlet during forward flow. If the auxiliary pump is of greater capacity than the timing pump it becomes a circulating pump and a sanitary recirculating line between the outlet of the heater and the inlet of the circulating pump shall be provided. The product pressure at the inlet of the flow diversion device shall be less than the maximum product pressure at which the flow diversion device will move from the forward flow position to the diverted flow position. This may be accomplished by one of the following:

F.19.3.1

Use of a circulating pump having a maximum output pressure of less than the maximum product pressure at which the flow diversion device will move from the forward flow position to the diverted flow position.

F.19.3.2

Installation of a pressure control valve in the recirculating line which will be set and sealed at a pressure less than the maximum product pressure at which the flow diversion device will move from the forward flow position to the diverted flow position.

F.19.3.3

Altering or rebuilding the flow diversion device so that the maximum product pressure at which it will move from the forward flow position to the diverted flow position is greater than the maximum output pressure of the circulating pump.

Substitute the following for subsection 5 of F.21.1.1 Tests:

5. Continuous Flow Holders

- A. Holding time of HTST pasteurizers used to repasteurize a concentrated milk product for drying in a process in which the product pressure required for drying is at least 300 pounds per square inch shall conform with the "Determination of Holding Time (Calculated Method)" See Section L. of these Practices.
- B. Holding time of all other HTST pasteurizers (Test No. 11, page 23 of PHS Publication No. 731)

Note: The holding time test shall conform with the "Determination of Holding Time (Salt Con-

ductivity Test). See Section I. of these Practices.

- C. Before starting the holding time test, water should be circulated thru the pasteurizer until all air is expelled.

Add the following to section F.21.1.1 Tests:

8. The following are modifications of and an additional test for the recorder-controller, the auxiliary temperature sensor-controller and the time delay relay incorporated in a HTST pasteurization system supplying repasteurized product to a drier with the timing pump located as provided for in F.3.2.

8.1 Recorder-Controller

Cut-In and Cut-Out

The procedure of Test No. 10, page 11 is to be modified for the cut-in test by observing when the temperature of the water of the product surrounding the temperature sensor of the recorder-controller reaches the temperature at which the control mechanism is set instead of observing the temperature at which forward flow begins.

8.2 Auxiliary Temperature Sensor-Controller

The following are modifications of the procedures in the Public Health Service Publication No. 731 "Procedures for Testing Pasteurization Equipment" and are for use in testing an auxiliary temperature sensor-controller that does not have an element that indicates or records the temperature at the temperature sensor. If the temperature sensor of the auxiliary temperature sensor-controller does actuate either a recording or indicating thermometer, the procedures in Publication No. 731, possibly with slight modifications, shall be followed.

Temperature accuracy. The procedure of Test No. 2, page 9 is to be modified by using the cut-out temperature as the means of determining whether or not the controller will return to within 1F of its setting after the sensor bulb has been exposed to boiling water and melted ice. A second modification is to use the pasteurization temperature of 175 F instead of 161 F.

Thermometric response. The procedure of Test No. 8, page 12 is to be modified by using a second water bath maintained at 12 F below the cut-in temperature. The water in the second water bath is to be vigorously agitated while performing the test. The procedure is

to (1) determine the cut-in temperature, (2) immerse the sensor bulb in the water bath maintained at 12 F below the cut-in temperature for five minutes (3) remove the sensor bulb from the one maintained at 12 F below the cut-in temperature and immediately immerse it in the water bath maintained 7 F above the cut-in temperature and (4) measure the time from the instant the sensor bulb is immersed in the second water bath until cut-in occurs.

Cut-in and Cut-out. The procedure of Test No. 10, page 11 is to be modified by observing the pilot light (or other means provided to comply with E.6.8.1) instead of observing when forward flow begins or stops.

8.3 Time Delay Relay Provided to Comply With E.6.8

Operate the HTST unit in diverted flow with the heating medium two or three degrees below the temperature normally required to establish forward flow. Gradually increase the product temperature at a rate not exceeding 1F every 30 seconds. By use of a stop watch, determine the time between the moment the temperature sensors of both the auxiliary temperature sensor controller and the recorder-controller are at or above the temperature their control mechanisms are set and the moment forward flow begins.

Add a new section L., to follow section K., as follows:

L.

Determination of Holding Time

(Calculated Method)

L.1

Method

L.1.1

Fully developed laminar flow is assumed, and holding-tube length is calculated. An experimental determination of pumping rate is required; this is accomplished by determining the time required for the pasteurizer to fill a vessel of known volume with water, converting these data by division to obtain flow rate in gallons per minute, and multiplying this value by the proper number in Table 1 in L.4 to obtain the required length of holding tube.

L.2

Test Procedure

L.2.1

Examine the entire system to ensure that all flow-promoting equipment is operating at maximum

capacity and all flow-impeding equipment is so adjusted or bypassed to provide the minimum of resistance to the flow. This means that in-line filters must be removed, booster pumps must be in operation, and vacuum equipment in the system must be operating at maximum vacuum. Also, before the tests are begun, the pasteurizer should be operated at maximum flow for a sufficient time to purge air from the system (about 15 minutes) and pipe connections on the suction side of the timing pump should be made tight enough to exclude entrance of air. With the pasteurizer operating with water, adjust the timing pump to its maximum capacity (preferably with a new belt.) Determine that no flow exists in the diverted flow line.

L.2.2

Measure the time required to deliver a known volume of water at the pasteurized product outlet. Repeat the test at least once to determine that the measurements are consistent.

L.2.3

Repeat the above step in diverted flow by measuring the time required to deliver a known volume of water at the discharge of the diverted flow line.

L.2.4

Select the greatest flow rate (shortest delivery time for the known volume) and calculate the flow rate in gallons per minute by dividing the known volume by the time required to collect the known volume; thus, if 2 minutes are required to fill a 10-gallon can, then flow rate is 5 gallons per minute. Multiply this value with the appropriate value in Table 1 in L.4 to determine the required holding-tube length.

L.2.5

For pasteurizers of large capacity, the method of measuring the flow rate at the pasteurized product outlet and at the discharge of the diverted flow line is inconvenient and the following alternate procedure may be used. Prevent any water from being added to the raw product constant level tank while determining the flow rate. Suspend a dip stick in the raw product constant level tank, and operate the pasteurizer at maximum capacity. Record the time required for the water level to move from one graduation to a lower graduation on the dip stick. The volume of water removed is calculated from the dimensions of the raw product constant level tank and the drop in water level. Flow rate is determined as follows: divide the volume of water removed from the raw product constant level tank by the time required to remove it.

L.2.6

Determine the number and type of fittings in the holding tube and convert these to equivalent lengths of straight pipe with the use of Table 2 in L.5. Determine the total length of the holding tube by adding the equivalent length of the fittings to the measured straight lengths of pipe.

L.2.7

Record the number and type of fittings, the number and length of straight pipes, and the holding-tube configuration.

L.3

Corrective Action

L.3.1

If the length of the holding tube is shorter than the calculated length, reseal the metering pump at a slower maximum capacity or lengthen the holding tube, or both, and repeat the above determination.

L.4

TABLE 1. HOLDING TUBE LENGTHS IN INCHES FOR HTST PASTEURIZATION WITH A PUMPING RATE OF 1 GALLON PER MINUTE

Holding Time, Seconds	Tubing Size (Outside Diameter), Inches				
	1	1-1/2	2	2-1/2	3
15.0	180.75	74.82	42.06	26.18	17.86
25.0	301.25	124.69	70.09	43.63	29.76

L.5

TABLE 2. CENTERLINE DISTANCES IN INCHES OF 3-A SANITARY FITTINGS^a

3-A Designation	Fitting Size, Inches				
	1	1-1/2	2	2-1/2	3
2 C 90° bend ^b	3.4	4.8	6.2	8.0	9.7
2 CG 90° bend ^b	3.1	4.5	5.8	7.6	9.3
2 F 90° bend	3.4	4.8	6.2	8.0	9.7
2 FG 90° bend	3.1	4.5	5.8	7.6	9.3
2 E 90° bend	3.4	4.8	6.2	8.0	9.7
2 EG 90° bend	3.2	4.6	6.0	7.7	9.4

^a3-A "Sanitary Standards for Fittings Used on Milk and Milk Products Equipment and Used on Sanitary Lines Conducting Milk and Milk Products," Serial No. 0800 and Supplements thereto.

^bThe designation 2 C identifies a bevel seat fitting; 2 CG identifies a gasket seat fitting.

NOTE:

The material in this Section L is a portion of "Performance Tests for Plate Heat Exchangers Used for Ultra High Temperature Pasteurization Processes"—Public Health Service Publication No. 999-UIH-12-1968 which has been revised slightly to adapt it to these HTST Practices.

This Amendment shall become effective June 7, 1969.

Figure 21. HTST pasteurizer used to repasteurize a concentrated milk product for drying in a process in which the product pressure required for drying is at least 300 pounds per square inch. (Timing pump located downstream of the flow diversion device.)

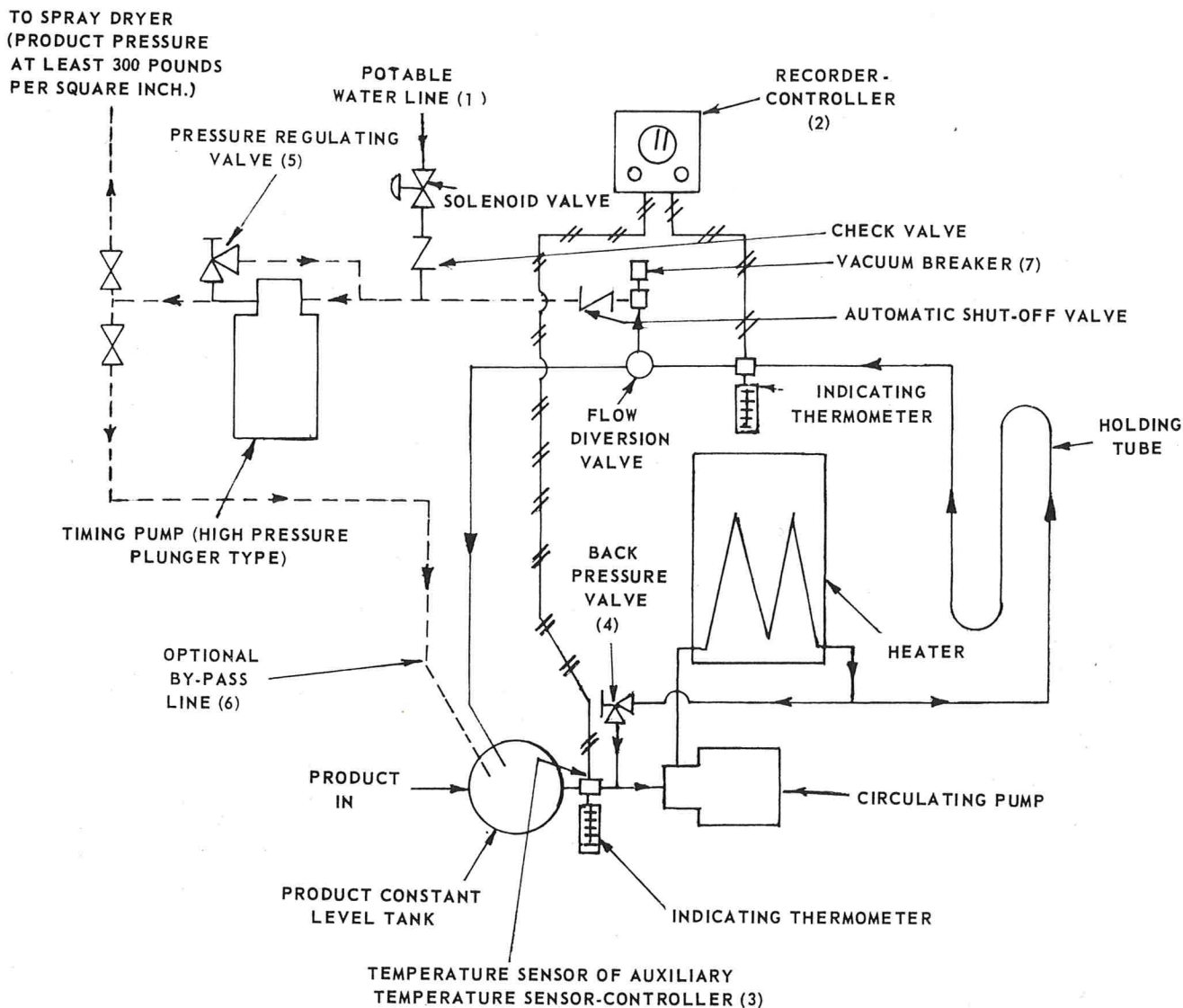

¹Potable water line is optional. To prevent damage to the timing pump, it is strongly recommended that the potable water line be provided and that the solenoid valve be inter-wired with the recorder-controller and flow diversion device so that when the latter assumes the diverted flow position the solenoid valve will open.

²The recorder-controller shown here includes the controller of the auxiliary temperature sensor-controller and the time delay relay required in E.6.8.

³Temperature sensor of the auxiliary temperature sensor-controller required in E.6.8, located as required in E.9.5.

⁴Pressure control valve to assure positive product pressure at the high pressure plunger type pump inlet. The pressure setting device of the valve is to be set at a product pressure less than the product pressure at which the flow diversion valve will move from the forward flow position to the diverted flow position.

⁵In many high pressure plunger type pumps this valve is a part of the pump.

⁶By-pass line is optional for rinsing, cleaning and sanitizing. Line may discharge to waste.

⁷Vacuum breaker. See E.9.6.2 for requirements.

Any other combination or modifications which are installed and operated in accordance with the above, and with the detailed provisions of the Practices may be utilized.

ASSOCIATION AFFAIRS

ANNUAL MEETING VIRGINIA ASSOCIATION OF SANITARIANS AND DAIRY FIELDMEN MARCH 6 AND 7, 1969

The Annual Meeting of the Virginia Association of Sanitarians and Dairy Plant Fieldmen was held at Virginia Polytechnic Institute, Blacksburg, Virginia, March 6 and 7. An outstanding program was presented.

The attendance at the meeting was excellent and some of the high lights of the program were: Importance of Milk and Milk Products in Children's Diets, Dr. R. P. Abernathy, Associate Professor, V. P. I.; Anaerobic Bacteria in Foods, Dr. Louis Smith, Pro-

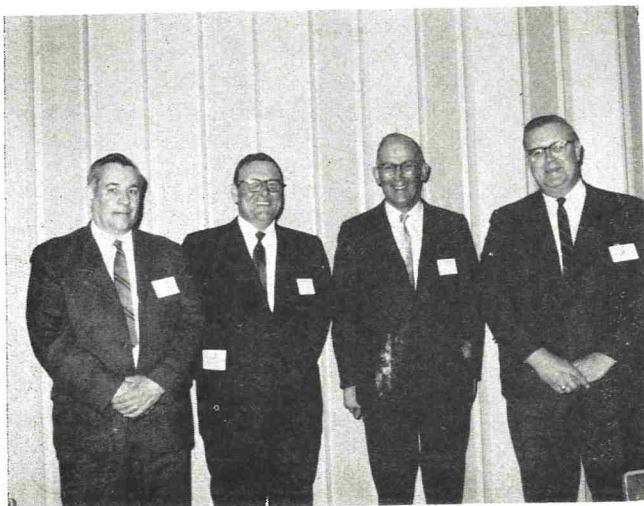

New officers Virginia Association of Sanitarians and Dairy Fieldmen. L. to R. R. J. Schutrumpf, 2nd Vice Pres., F. S. Shockey, President, J. H. McGavock, 1st Vice Pres. and W. H. Gill, Secretary-Treasurer.



Milk Break—Dr. Baldwin, Jay Taylor, G. I. Morgan.

fessor Bacteriology, V.P.I.; 3-A Sanitary Standards for Milking Machines, James B. Smathers, Director of Field Services, Maryland-Virginia Milk Producers Association, Arlington, Va.; Identifying Abnormal Milk, Dr. J. W. Smith, Animal Husbandry Research Center, U.S.D.A., Beltsville, Md.; Producing High Quality Milk Raw Milk, a panel discussion by Frank Overstreet, Maryland-Virginia Milk Producers Association, James W. Sink, Dept. of Agric. and Comm., Carl Bussey, Sealtest Foods; Laboratory Activities Panel, Dr. E. N. Boyd moderator, W. L. Arledge, Lab Director, Dairymen, Inc., Bristol, Va., Charles Sumpster, Lynchburg Laboratory, Lynchburg, Va. and J. W. Smith, V.P.I.; Field Activities Panel, Dr. Joseph A. Lineweaver, Moderator, Dairy Science Dept., V.P.I., N. L. Franklin, Chief, Dairy Records and Testing, Dept. of Agric., Richmond, Va., Archie C. Holaday, President, Virginia Association of Sanitarians and Dairy Fieldmen, Richmond, Va.; Trends in Cooperative Marketing of Milk, Judd Mason, National Milk Producers Federation, Washington, D. C.; Increasing Shelf Life of Perishable Food, Dr. Marvin Speck, Professor, Food Science Dept., N. C. State Univ., Raleigh, N. C.

NEWS FROM ONTARIO MILK AND FOOD SANITARIANS ASSOCIATION

Ontario Association's Annual Golf Tournament

The annual Golf Tournament will be held on Wednesday, June 4th, 1969, at Hilltop Lodge and Country Club, Erin, Ontario, at 12 o'clock noon, to 5 p.m. Banquet will follow.

Annual Meeting, 1970

The annual meeting of the Ontario Milk and Food Sanitarians Association will be held on January 28th, 1970, at the Holiday Inn, Highway 27, northwest of Toronto.

Directors' Meeting

A meeting of the Directors of the Association was held on Monday, April 7th. Activities for the year were planned and a program designed to broaden the interest in conformity with the addition of "Food" in the association's name, was discussed at length. Committees were appointed to investigate the possibility of cooperation and the securing of speakers on several phases of work in the wider field, Herman Cauthers was appointed Ambassador at Large, and ex-Officio member of the Board.

Dairy Plant Fieldmen's Conference

A conference of Dairy Plant Fieldmen was held at Guelph University on April 2nd. Among the speakers were a number of our members. Past President, Ray Bowles discussed the value of in-line saniquard screen filters at the bulk tank outlet. (Association members who attended the annual meeting will recall the display of these filters which attracted so much interest and evoked considerable surprise.)

Dr. A. N. Myhr reviewed a study of cooling performances and temperature stratification in farm bulk milk cooling tanks. Professor A. G. Leggatt projected what the change from resazurin test to the plate count would mean to producers. W. G. Johnson, Area Fieldman of the Ontario Milk Commission analysed the comparative quality test results on milk produced by fluid versus manufacturing milk shippers. Dr. F. C. Nelson, Vet. Services, discussed the value of the Gel test as a measure of mastitis in the dairy herd. Dr. D. A. Barnum, O.V.C., talked on the public health significance of staphylococcol mastitis, and can this form of the disease be cured? Dr. K. A. McEwan, Vet. Services, offered an evaluation of the Ontario Mastitis control program—its successes and failures.

NOTE: Due to the date, it was impossible to give more than the topic matter of the papers presented at Dairy Plant Fieldman's conference. However, because of the apparent general interest to milk sanitarians, particularly, an effort will be made to secure copies of the papers and digests, at least, can be offered in future issues.—Editor.)

ANNUAL MEETING OF FLORIDA ASSOCIATION OF MILK, FOOD AND ENVIRONMENTAL SANITARIANS, INC. AND MILK LABORATORY TECHNICIANS APRIL 22-24, 1969

The Florida Association and Milk Laboratory Technicians held their annual meeting at the Ramada Inn, Gainesville with well over 100 in attendance. Jay Boosinger, Secretary-Treasurer and the Membership Committee reported that the Florida Association has doubled the membership this past year. Certainly a most outstanding accomplishment and the program committee presented a most interesting program. Some of the topics presented in brief are: Sources of High Counts in Raw Milk, Dr. C. K. Johns; Citrus Processing, Handling and Packaging; The Causes and Detection of Pathogens in Milk, Dr. Kenneth L. Smith; Certification Process for Abnormal Milk, Edwin H. Connell; Freeze Dried Convenience Food Processing Sanitation Standards, Dr. Richard Matthews; Cleaned-in-Place Lines and Equipment,

Robert Griffin; Beverage Bottling Sanitation, E. A. Baker, Manager Quality Control, Coco-Cola Co., Atlanta, Ga.; Shrimp, the People Who Process it and the Sanitation Problems They are Attempting to Solve, Donald J. Toloday, Quality Control Director, Singleton Packing Co.

REPORT ON THE COMMITTEE ON APPLIED LABORATORY METHODS, 1967-1968

During the past 2 years, the Committee on Applied Laboratory Methods has actively provided assistance and consultation in the following areas: (a) Preparation and publication of the 12th edition of *Standard Methods for the Examination of Dairy Products* (SMEDP). Eleven members served on the American Public Health Association (APHA) Subcommittee responsible for the publication of this manual. (b) Provided assistance to a Subcommittee of the Public Health Committee of the American Dairy Science Association, which has recommended that methods contained in future editions of SMEDP be subjected to an organized continuing activity for their development and evaluation. (c) Developed a continuing program for evaluation of methods included in the 12th edition of SMEDP, which should be useful in the preparation of the next edition. (d) Assisted in collaborative studies concerned with established, defined, and accepted methods for the examination of various foods. (e) Encouraged certification of media in all disciplines concerned with proficiency testing of laboratory methods. The need for certification of *all* media and reagents used in biological laboratories for the examination of human, animal, water, and food specimens has not been successfully stressed. Various lots (batches) of selective and differential media sold by media manufacturers should have approximately the same productivity and recovery levels when typical, atypical, or attenuated strains of pathogenic or "indicator" microorganisms are present. This problem is of international as well as national importance. The development of microbiological standards for food can be stymied by irregular results from media of unknown productivity. The interim report of this committee (*Journal of Milk and Food Technology*, March, 1966) showed 4 goals; the most important goal then, and now, is the need for certification of all media and reagents used in sanitation, diagnostic, and clinical laboratories. The committee believes that all laboratory administrators and research workers in microbiological disciplines should be cognizant of potential variations in results when non-standardized media and/or reagents are used. A recent paper by Read and Reyes "Variation in Plating Efficiency of Salmonellae on Eight Lots of Brilliant Green Agar" (*Applied Microbiology*, May, 1968) has alerted laboratory administrators to this problem. The authors state: "Productivity problems with individual lots of this medium may also account for the inability of people in one laboratory to use successfully a method found to be excellent in another." The committee hopes that laboratory workers experiencing similar difficulties with different lots of media and/or reagents will publish their data to further emphasize the need for such standardization.

In general, the Subcommittees on Laboratory Methods for the Examination of Milk and Milk Products; Water and Other Environmental Samples; and Foods have been handicapped

by lack of either sufficient personnel to assist in committee contributions or funds to conduct studies to provide valuable and useful data in the evaluation of new and old laboratory methods. The latter problem is particularly applicable to many of the committee members who are affiliated with universities or colleges and who have applied for federal research grants and/or contracts. Although most of these applications have been approved, monies have not been allocated to fund the research projects at their educational institutions. A few members of one or two of the subcommittee are dependent on additional avenues for funds to fulfill committee responsibilities; however, the Chairman believes that future commitments of the Applied Laboratory Methods Committee may have to be limited unless more committee members have monies and personnel available for projects.

SUBCOMMITTEE ON LABORATORY METHODS FOR THE EXAMINATION OF MILK AND MILK PRODUCTS

Activities. Inasmuch as the 12th edition of SMEDP is now a reality, this committee is presently aligning its activities to assist in preparation of the 13th edition. Upon recommendation of the American Dairy Science Association (*Journal of Dairy Science*, January, 1968) and the International Association of Milk, Food and Environmental Sanitarians (ALM Interim Report—1966-1968, *Journal of Milk and Food Technology*, November, 1967) a change in policy has been effected for publication of the 13th edition. On June 28, 1968, APHA entered into a 3-year contract with the Public Health Service for "Development, Evaluation, and Publication of Standard Methods for the Examination of Dairy Products." Under the terms of the contract, the APHA shall establish a Council composed of persons with recognized ability in the field of dairy products laboratory examinations. "The members of this Council shall represent interested professional organizations and the Public Health Service." The International Association of Milk, Food, and Environmental Sanitarians will be contacted to select a representative for the Council. In addition to providing an administrative base for this council, the APHA shall be responsible for: (a) Continuing review and evaluation of methods in the 12th edition of SMEDP, including modifying or discontinuing methods when warranted. (b) Arranging, through the Council, for collaborative studies on methods that merit consideration or reconsideration as candidate standard methods. A method that shows promise of acceptance shall be designated as a Provisional Standard Method when published in an appropriate journal. Normally, 1 year after collaborative studies on each method have been conducted and the value of the method has been conclusively established, a majority vote by the Council shall be necessary to determine whether the method being considered is suitable as a standard method. (c) Establishing a mechanism for the addition, modification, or deletion of a standard method between publication of successive editions of SMEDP. (d) Appropriately recognizing all contributing groups in all new editions of SMEDP. (e) Assisting researchers in obtaining financial support for research directed toward the development of microbiological analytical methods applicable to SMEDP.

During the past 1.5 years, Dr. Levowitz (now deceased) and Dr. Brazis were active on the National Mastitis Council (NMC) Subcommittee on Screening Tests. This subcommittee, chaired by Dr. Brazis, has 2 charges, the first of which has been completed: (a) evaluation and standardization of the Direct Microscopic Leukocyte Count, and (b) evaluation

and assessment of proposals for the examination of gel, leukocyte, and somatic cell methods for bulk milk samples. A direct microscopic procedure using a modified strip method has been standardized and shows considerable promise because of its precision. Three papers associated with development of this method shall be submitted to the *Journal of Milk and Food Technology* for immediate publication, if accepted. The titles of these papers are: (a) "Direct Microscopic Somatic Cell Count in Milk," (b) "The Design of An Eyepiece Reticle for Use in the Direct Microscopic Somatic Cell Count Method," and (c) "Development and Evaluation of the Direct Microscopic Somatic Cell Count (DMSCC) in Milk." The NMC Subcommittee hope to have all three papers published in the same issue of the Journal.

SUBCOMMITTEE ON LABORATORY METHODS FOR THE EXAMINATION ON WATER AND OTHER ENVIRONMENTAL SAMPLES

Activities. The progress of this subcommittee has been slow, but studies are proceeding on the growth pattern of coliforms that show small and/or slow lactose fermentation in lactose and lauryl sulfate tryptose broths. These organisms are now being found in increasing numbers in waters, food, feces, etc.; although they show little or no growth in lactose broth in 48 hr, various amounts of gas are produced after 3 to 5 days. These same microorganisms when inoculated from positive lactose broth tubes into brilliant green bile lactose broth (BGBLB) frequently confirm in 24 to 48 hr. Although little has been published on the growth pattern of these microorganisms, it is anticipated that lauryl tryptose broth may increase generation times of these cells. Unpublished data (Brazis, 1967) from studies in which these groups of microorganisms were used indicated that with some lots of lactose broth small amounts of gas were observed in 48 hr; other lots of lactose broth showed no gas, although growth was evident; in all instances, small amounts of gas were observed in BGBLB in 24-48 hr, even when inocula from lactose tubes not showing gas were inoculated into BGBLB. Similar studies were also conducted with different lots of lauryl sulfate tryptose broth (LST); most of the lots of LST broth showed gas in 24-48 hr and confirmed in BGBLB in 24-48 hr. Because of the importance of this group of coliform organisms, additional studies are necessary. Media used by all participating laboratories should be standardized.

SUBCOMMITTEE ON LABORATORY METHODS FOR THE EXAMINATION OF FOODS

Activities. The progress of activities of this subcommittee appears slow because many requirements limit processing of methods, and the task of achieving acceptance of methods is cumbersome. The National Academy of Sciences National Research Council (NAS-NRC) is expected to publish methods soon for the detection of *Clostridium botulinum* and its toxins, aflatoxins, total mesophilic counts, coliform counts, and salmonellae. Under the auspices of the Association of Official Analytical Chemists (AOAC), a collaborative study, under the direction of Dr. Hall, on methods for the detection and quantification of *Clostridium perfringens* in food has been completed, and publication of the results is anticipated in the near future. As indicated previously in the interim report of this subcommittee (*Journal of Milk and Food Technology*, December, 1966), much of its activities should be in the form of assistance to the AOAC rather than to conduct separate

subcommittee studies. The AOAC has recently published a paper on detection of salmonellae in eggs; a collaborative study on *Clostridium perfringens* is finished but the results have not been published; another collaborative study by AOAC is now being conducted on the isolation of salmonellae from dry milk.

Currently, at least 3 groups concerned with food microbiology are working independently towards a common goal. It is anticipated that reference procedures will be developed for the important food pathogens and toxins, indicator organisms, and total mesophilic counts. It is not known, however, when these procedures will be published in a format suitable for use by food microbiologists. A report prepared by Dr. F. S. Thatcher, Chairman, International Committee on Microbiological Specifications for Foods, is expected to be published in the Fall of 1968.

DR. A. RICHARD BRAZIS, Chairman, *Applied Laboratory Methods Committee*, Milk Sanitation Research, Public Health Service, 222 E. Central Parkway, Cincinnati, Ohio 45202.

Subcommittee on Laboratory Methods for the Examination of Milk and Milk Products

DR. ELMER MARTH, Chairman, Department of Food Science and Industries, University of Wisconsin, Madison, Wisconsin 53706.

WILLIAM L. ARLEDGE, Southeast Milk Sales, P. O. Box 1099, 283 Bonham Road, Bristol, Virginia 24201.

CECIL B. DONNELLY, 222 E. Central Parkway, Cincinnati, Ohio 45202.

ROY E. GINN, *Director, Quality Control Laboratory*, Quality Control Committee, 2274 Como Avenue West, St. Paul, Minnesota 55108.

C. N. HUHTANEN, Eastern Utilization Research and Development Division, Agricultural Research Service, U. S. Department of Agriculture, 600 East Mermaid Lane, Philadelphia, Pennsylvania 19118.

DR. J. J. JEZESKI, Department of Food Science and Industries, University of Minnesota, St. Paul, Minnesota 55101.

DR. EARL W. COOK, *Director*, Quality Control Laboratory Division, Industrial Highway, Southampton, Pennsylvania 18966.

DR. DAVID LEVOWITZ (deceased), New Jersey Dairy Laboratories, P. O. Box 748, New Brunswick, New Jersey 08903.

DR. F. E. NELSON, Department of Dairy Science, University of Arizona, Tucson, Arizona.

DR. H. E. RANDOLPH, Department of Animal Science, Texas A and M University, College Station, Texas 77843.

DONALD THOMPSON, State Laboratory of Hygiene, 437 Henry Mall, Madison, Wisconsin 53706.

Subcommittee on Laboratory Methods for the Examination of Water and Other Environmental Samples

DAVID Q. ANDERSON, *Acting Chairman*, Utah State Department of Health, 44 Medical Drive, Salt Lake City, Utah 84113.

DR. MARTIN FAVERO, 4402 North Seventh Street, Phoenix, Arizona 85013.

C. N. HUHTANEN, Eastern Utilization Research and Development Division, Agricultural Research Service, U. S. Department of Agriculture, 600 East Mermaid Lane, Philadelphia, Pennsylvania 19118.

DR. R. L. MORRIS, State Hygienic Laboratory, State University of Iowa, Iowa City, Iowa 52241.

ARNOLD SALINGER, Bureau of Laboratories, Maryland State Department of Health, Baltimore, Maryland 21218.

Subcommittee on Laboratory Methods for the Examination of Foods

DR. HERBERT E. HALL, *Chairman*, 222 E. Central Parkway, Cincinnati, Ohio 45202.

DR. ROBERT ANGELOTTI, 550 Main Street, Cincinnati, Ohio 45202.

DR. LAURENCE G. HARMON, Department of Food Science, Michigan State University, East Lansing, Michigan.

J. C. MCCAFFREY, Illinois Department of Public Health, 1800 West Fillmore Street, Chicago, Illinois 60612.

NEWS AND EVENTS

REVISIONS AND AMENDMENTS TO 3-A SANITARY STANDARDS ADOPTED

Two major revisions to published standards were adopted as final; two important, though brief, amendments were concluded; a new tentative accepted practices, and two tentative standards were also reviewed at the semi-annual meeting of the 3-A Sanitary Standards Committees for dairy processing equipment, March 11-13, 1969, Palm Springs, California. Nearly 80 users, sanitarians, and equipment fabricators attended the three-day sessions planned around a heavy agenda relating to dairy foods equipment.

The revisions adopted were complete rewrites and up-dating of old 3-A Standards for Sanitary Fittings, and for Evaporators. Amendments concluded were those for two compartment truck tanks, and leak protector valves for pasteurizers with vertical outlets. Completion of these projects reflects the organization's philosophy of technological up-dating of existing standards and practices. This series of amendments and revisions will be prepared for signing and publication in the Journal of Milk and Food Technology later in the year. Effective dates will be announced at that time.

In addition to the completed projects, the 3-A Committees reviewed new tentative accepted practices for spray drying systems, for instantizers for dry milk, and for sanitary meters. These were referred back to the respective task committees for further changes and re-drafting.

Reinforced epoxy resins have been added to the established generic classes of plastics used for dairy equipment by an amendment signed April 28. Amendment #2003 is the third for the purpose of adding a new generic class of resins to "3-A Sanitary Stand-

ards for Multiple-Use Plastic Materials Used as Product Contact Surfaces for Dairy Equipment," Serial #2000. The Standard provides criteria for evaluating cleanability and re-use for a large group of plastics previously cleared for safety under the Food, Drug, and Cosmetic Act.

**AFDOUS CONFERENCE
MIAMI BEACH, FLORIDA
JUNE 15-19, '69**

"Our program is complete and it looks like the 1969 conference of the Association of Food and Drug Officials of the United States will be the best ever," according to Eaton E. Smith, association president. Joining Dr. Herbert L. Ley, Jr., commissioner of the Food and Drug Administration, Dr. Charles G. Moertel of the Mayo Clinic, Dr. Bernard Oser, Institute of Food Technologists president, and Parke C. Brinkley of the National Agricultural Chemicals Association, as speakers will be twenty others.

Food technology, agricultural chemicals, a universal drug identification system and the current and future role of the Food and Drug Administration are but a few of the topics to be discussed. A panel discussion "Filled and Imitation Dairy Products" will feature Clifton Ward, assistant commissioner for the Georgia Department of Agriculture, Charles M. Fistere, an attorney from Washington, D. C., and Donald Daffron, administrative assistant with the Memphis-Shelby County Health Department, on the Southern Association's meeting June 17. Moderator will be Dr. Joe Cardwell, president of the Association, Southern States.

This will be followed by a report from the Southern states on current food and drug problems. Speakers will be Dr. Sam Cox, director of the Mississippi Meat Inspection Division, who will discuss "Meat and Meat Products"; Raymond Summerlin, director of the Georgia Department of Agriculture's consumer protection division, "Inspection, Sampling and Administrative Procedures on Bakery Products," joined by Eugene H. Holeman, director and state chemist for the Tennessee Department of Agriculture's food and drug division; and Doyle C. Golden, chief of the Florida Department of Agriculture's pesticide residue section, who will talk about "The Use of Pesticides and the Control of Pesticides in Foods."

WALKER
Filter-Flo
SANITARY MANHOLE VENT
Patent No. 3377784



**POSITIVELY PROTECTS TANKER CONTENTS
AGAINST DUST, INSECTS and FOREIGN MATTER**

Fast — takes only seconds to attach.

Convenient - portable, lightweight (14 lbs.).

Versatile — fits all model tanks.

Sanitary — all welds ground and polished. Top cover protects filter pad.

Economical — one unit can be used for each unloading area.

Safe — protects against internal vacuum while unloading.

Proven

IN HUNDREDS
OF
INSTALLATIONS

SANITARY PROTECTION WITH MANHOLE COMPLETELY OPEN WHILE UNLOADING

\$160⁰⁰
Price F.O.B. New Lisbon, Wis.
2" 15R fitting for air agitation add \$29.50

Unique venting design permits adequate air flow for 3" capacity pump.

Accepts standard 9 1/2" replaceable filter pads.

All stainless steel sanitary construction. Easy to keep clean.

WALKER
**WALKER STAINLESS
EQUIPMENT CO., INC.**
New Lisbon, Wisconsin 53950 • (608) 562-3151

Application for Membership

**INTERNATIONAL ASSOCIATION OF MILK, FOOD & ENVIRONMENTAL
SANITARIANS, INC.**

Box 437, Shelbyville, Indiana 46176

Name ----- Date -----
Please Print

Address ----- Renewal
----- Zip Code ----- New

Business Affiliation ----- Re-instatement

Direct Member Annual Dues \$10.00 Check Cash
Membership Through An Affiliate—\$8.00 Plus Affiliate Dues
(Membership Includes Subscription to Journal of Milk & Food Technology.)

Please Print

Recommended by -----

Shelbyville, Ind.
Box 437

Subscription Order

JOURNAL OF MILK & FOOD TECHNOLOGY
(Monthly Publication)

Name ----- Date -----
Please Print

Address ----- New
----- Renewal

Educational Institution & Public Libraries Individual Non-Member Subscription (Annually) \$10.00
(Annually) \$8.00 Check Cash Government Agencies, Commercial Organizations
(Please Print)

I.A.M.F.E.S. & J.M.F.T.
Box 437, Shelbyville, Ind.

Change of Address

FROM

Name ----- Date -----
Please Print

Address -----

TO

Name -----
Please Print

Address -----

I.A.M.F.E.S. & J.M.F.T.
Box 437, Shelbyville, Ind.

Order for 3A Standards

Name ----- Date -----
Please Print

Address -----

() Complete Set @ \$4.50 = ----- () Complete set bound (durable cover) @ \$6.00 = -----
() Revised HTST Std.—without cover = \$1.00 F.O.B. Shelbyville, Ind.

3-A Accepted Practices For Milking Machines
1-100 = 25c ea.; 100-1000 = 20c ea.; 1000 or more = 15c ea.
5 Year Service on Standards as Published = \$3.50 additional

Order for Reprints of Articles

Amt. ----- Title -----

Schedule of prices for reprints F.O.B. Shelbyville, Indiana

	1 Page	2 Pages	3 & 4 Pages	6 & 8 Pages	12 Pages	Cover
100 or less	\$16.25	\$19.50	\$27.30	\$39.00	\$65.00	\$28.00
Add'l 100's	2.00	2.50	4.00	5.50	9.00	4.50

Is added water in the bulk or farm milk you purchase diluting your profit as well as your product?

AOAC, APHA and MIF test methods
endorse cryoscopy as the most accurate
practical way to measure added water

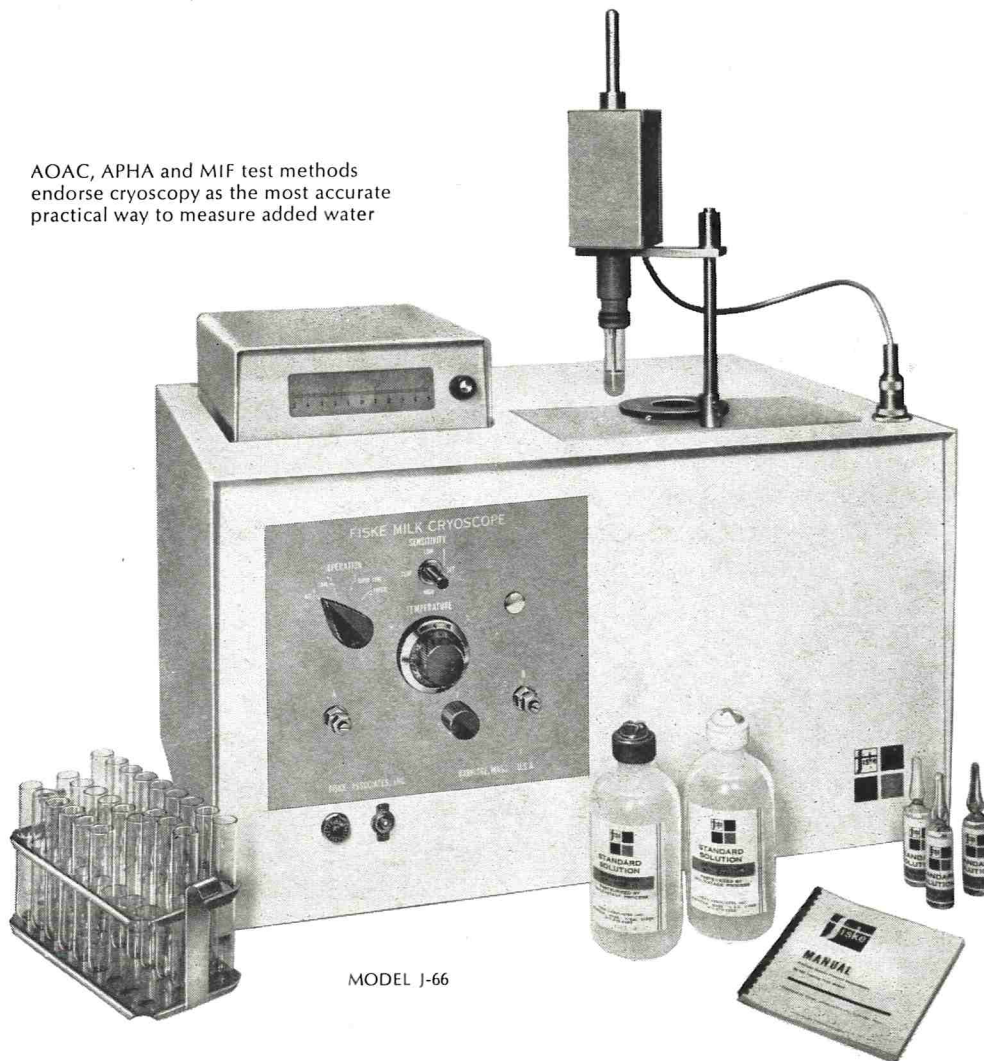

NOW AVAILABLE New Certified Reference Standards

On-the-shelf deterioration often impairs the accuracy of your calibration standards! Now you can cross-check them with exclusive new Fiske Certified Reference Standards. Packaged in convenient sets of four each with the same freezing point, the one-time ampoules are completely sealed and protected until the moment you use them.

Guard against added water with a Fiske Milk Cryoscope

You may be wasting several cents of every dollar you pay for milk due to the presence of excess water. Profit conscious dairymen (and who isn't) use Fiske Milk Cryoscopes to pin-point and reject milk supplies containing unacceptable amounts of added water. Resulting profit increases quickly write off the modest initial investment. In a matter of minutes anyone can learn to test as many as 200 samples in a single day with uniform accuracy guaranteed. Equally important, you can prevent customer dissatisfaction due to taste deterioration, thus preserving your reputation for quality . . . the reputation which pays off in added customers, sales and profits!

Please write or phone for complete information.

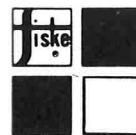

FISKE ASSOCIATES, INC.

Quaker Highway
Uxbridge, Mass. 01569
(617) 287-2482

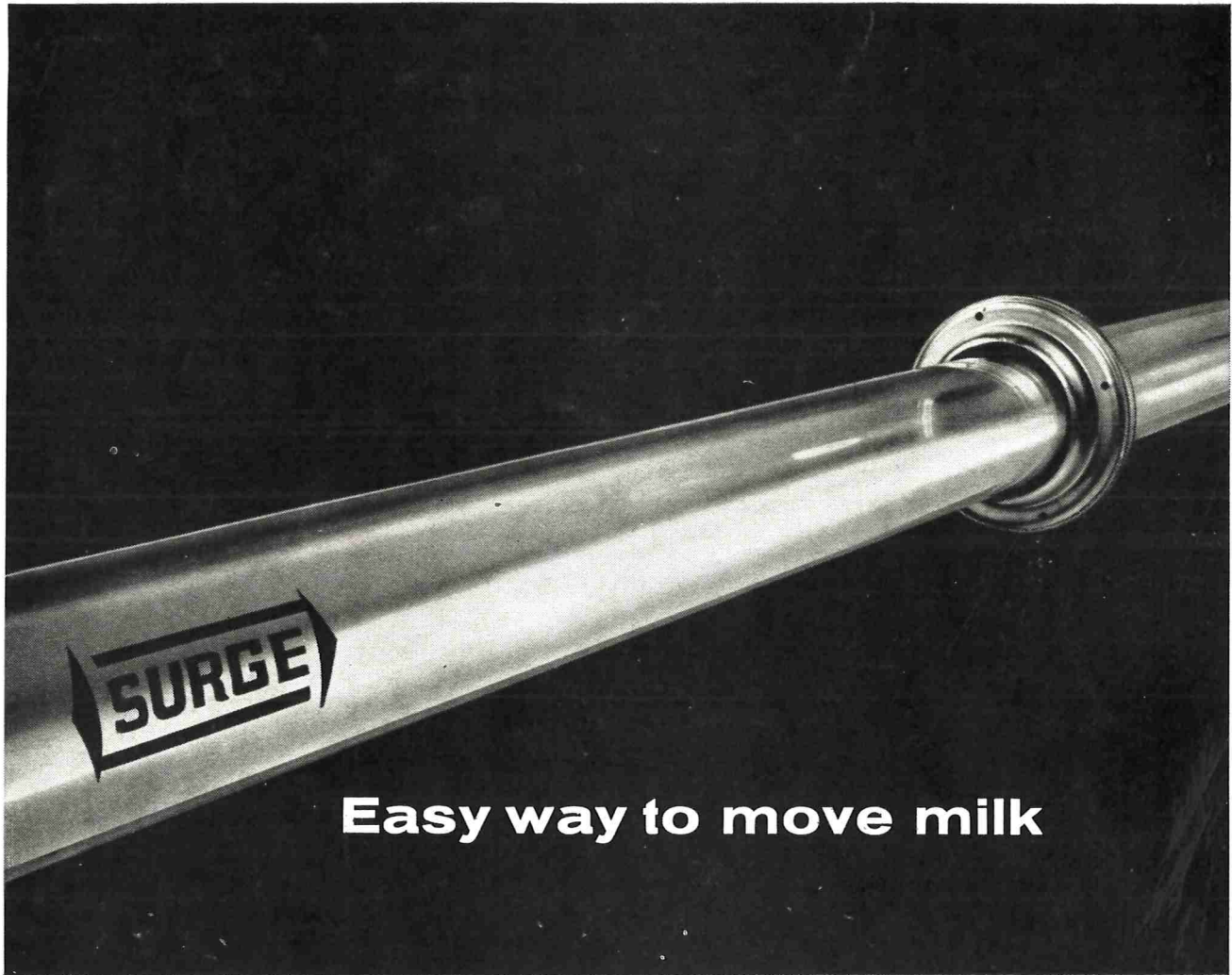

Easy way to move milk

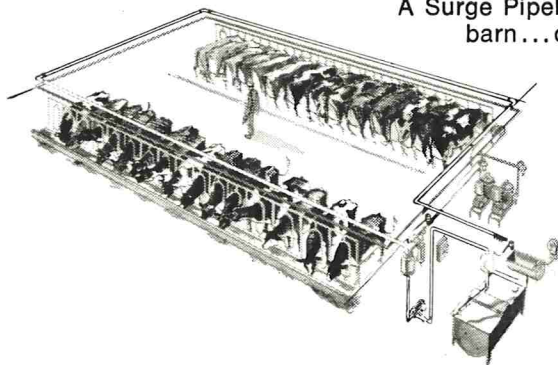

A Surge Pipeline Milking System...installed in your present stanchion barn...can save you all the work of carrying or transferring your milk and free your time for more important chores.

Whether you have a small or very large herd, a stanchion pipeline system is usually the least expensive way to automate your milking. And, the most reliable source to turn to is your local Surge Dealer. He has been carefully trained to plan a pipeline system to fit your present stanchion barn... fit your budget. And he has the experience and training to give you expert installation.

A full line of Surge equipment...known for quality throughout the world...is available through your Surge Dealer. He can offer you a choice of the Lo-Profile Breaker Cup or the new Surge Mini-Cup. Both milkers come equipped with new Jet-Flo inflations. And your Surge Pipeline Milking System can be ordered with manual cleaning or the Surge Electrobrain that cleans-in-place automatically. Just push a button and walk away...the Electrobrain does the rest.

Why waste your time carrying or transferring milk? Call your Surge Dealer today. Let him show you how a Surge Pipeline Milking System can be built into your present barn.



BABSON BROS. CO., OAK BROOK, ILLINOIS
BABSON BROS. CO., (Canada) LTD., PORT CREDIT, ONTARIO