

ISSN:0273-2866
Box 701
Ames, Iowa 50010

XEROX UNIV MICROFILMS
SERIALS DEPT
300 N ZEEB RD

ANN ARBOR, MI

48106

August 1986
Vol. 6, No. 8
Pages 325-372
\$6.00

Dairy and Food Sanitation[®]

A Publication of the International Association of Milk, Food and Environmental Sanitarians, Inc.

**Salmonella in Cooked
Beef: An Update**

**Evaluation of Reference
Test Methods Used
for Analyzing Milkfat**

**Whole Milk May
Protect Stomach
Against Ulcers**

**"Handling and
Evaluating Seafood"
Video from NIFI
Now Available**

**1985 Dry
Milk Census
Now Available**

**Dr. Elmer H. Marth
Receives Borden Award**



The Antibiotics Issue Is Crystal Clear

There's only *one* FDA-approved antibiotic test. The 2½ hour *B. stearo-thermophilus* disc assay.

And there's only *one* fast, reliable way to predict it. The 6-minute SPOT TEST.

The SPOT TEST screens an average of 50,000 milk tankers each month — with disc correlation unmatched by any quick test.

That's why dairymen across the country count on it for low-cost, trouble-free screening. And now, with a reformulated reagent system, SPOT TEST results are clearer than ever.

Your choice is just as clear. When you need to spot antibiotics fast, run The SPOT TEST. And get results in 6 minutes.

ANGENICS
100 Inman Street
Cambridge, MA 02139
617 876 6468



 **SPOT TEST™**

International Association of Milk, Food & Environmental Sanitarians, Inc.

1987 MEMBERSHIP APPLICATION

All memberships on calendar year basis, Memberships include a subscription to *Dairy and Food Sanitation* or both journals.

Check one:

- BEST BUY** Membership with BOTH journals \$50
(Dairy and Food Sanitation & Journal of Food Protection)
 Membership with *Dairy and Food Sanitation* \$28

FOREIGN AND CANADA

Add \$10 for each Journal ordered for postage

* Student Membership \$14 for DFS - \$25 for both - please include student verification

1987 SUBSCRIPTION APPLICATION for agencies, associations, and institutions

All subscriptions on a calendar year basis

BEST BUY

- BOTH Journals \$110
 Dairy and Food Sanitation \$60
 Journal of Food Protection \$80

FOREIGN AND CANADA

Add \$10 for each Journal ordered for postage

1987 PUBLICATION ORDER FORM

3-A Sanitary Standards

- () Complete set 3-A Dairy Stds ea \$33
() Complete set 3-A Dairy & Egg Stds ea \$48
() 3-A Egg Stds ea \$28

Five-Year Service on 3-A Sanitary Standards

- () 3-A Dairy & Egg Stds Five years \$34

- Procedures to Investigate Waterborne Illness ea \$3.00
 Procedures to Investigate Foodborne Illness ea \$3.00
 Procedures to Investigate Arthropod-borne and Rodent-borne Illness ea \$3.00

Multiple copies available at reduced price. Prices include postage.

Please fill out completely

Name _____ Company Name _____

Address _____

City _____ State/Province _____ Country _____ Zip _____

Phone with area code _____

Job Title _____

- Payment enclosed
 Mastercard/Visa (circle appropriate card)
Card # _____
Expiration Date _____
 Bill me (payment due upon receipt)
 Please check here if you would like information
on joining your state/province association.

U.S. FUNDS

MAIL ENTIRE FORM TODAY TO:

IAMFES-Dept. B
P.O. Box 701
Ames, IA 50010

Please circle No. 360 on your Reader Service Page

For faster service use your
charge card & call 800-525-5223
or 515-232-6699
ask for Sandy

IAMFES Sustaining Members

Accurate Metering Systems, Inc.
1705 Carmen Dr.
Elk Grove Vlg, IL 60007

Alfa-Laval, Inc.
Agri-Group
11100 North Congress Avenue
Kansas City, MO 64153

Alpha Chemical Services, Inc.
P.O. Box 431
Stoughton, MA 02072

Anderson Chemical Co.
Box 1041
Litchfield, MN 55355

Angenics, Inc.
100 Inman St.
Cambridge, MA 02139

Associated Milk Producers, Inc.
830 N. Meacham Rd.
Schaumburg, IL 60195

Babson Bros. Co.
2100 S. York Road
Oak Brook, Illinois 60521

BBL Microbiology Systems
P.O. Box 243
Cockeysville, MD 21030

Bio-Lab, Inc.
PO Box 1489
Decatur, GA 30031

Borden, Inc.
Dairy & Services Div.
16855 Northchase
Houston, TX 77060

CLN Industries, Inc.
700 Billings, Suite F
Denver, CO 80011

Dairymen, Inc.
10140 Linn Station Road
Louisville, KY 40223

Darigold
635 Elliott Ave. W.
Seattle, WA 98109

Dean Foods
1126 Kilburn Ave.
Rockford, IL 61101

Diversay/Wyandotte
1532 Biddle Ave.
Wyandotte, MI 48192

Eastern Crown, Inc.
P.O. Box 216
Vernon, N.Y. 13476

Foss Food Technology Corporation
10355 West 70th St.
Eden Prairie, MN 55444

FRM Chem, Inc.
P.O. Box 207
Washington, MO 63090

GAF
1361 Alps Road
Wayne, NJ 07470

Gerber Products Co.
445 State St.
Fremont, MI 49412

Gibco Laboratories, Inc.
231 Sutton Street
No. Andover, MA 01845

Gist-Brocades USA
P.O. Box 241068
Charlotte, NC 28224

Henkel Corp.
300 Brookside Ave.
Ambler, PA 19002

H. B. Fuller Co.
Monarch Chemicals Div.
3900 Jackson St. NE
Minneapolis, MN 55421

IBA Inc.
27 Providence Rd.
Millbury, MA 01527

Kendall Co.
One Federal St.
Boston, MA 02101

Kienzade Division
Economics Laboratory, Inc.
3050 Metro Drive
Suite 208

Bloomington, MN 55420

Maryland & Virginia Milk Prod. Assn., Inc.
P.O. Box 9154 Rosslyn Station
Arlington, Virginia 22209

Metz Sales, Inc.
522 West First Street
Williamsburg, PA 16693

Mid America Dairymen, Inc.
P.O. Box 1837 SSS
800 W. Tampa
Springfield, MO 65805

Nalge Co.
P.O. Box 365
Rochester, NY 14602

Nasco International
901 Janesville Ave.
Fort Atkinson, Wisconsin 53538

National Mastitis Council
1840 Wilson Blvd.
Arlington, VA 22201

National Milk Producers Federation
1840 Wilson Blvd.
Arlington, VA 22201

National Sanitation Foundation
P.O. Box 1468
Ann Arbor, MI 48106

Norton Co.
P.O. Box 350
Akron, Ohio 44309

Oxold USA, Inc.
9017 Red Branch Rd.
Columbia, MD 21045

Penclillin Assays, Inc.
36 Franklin St.
Malden, MA 02148

The Pillsbury Company
311 Second St., S.E.
Minneapolis, MN 55414

Rexham Machinery Group
5501 N. Washington Blvd.
Sarasota, FL 34243

Selberling Associates, Inc.
11415 Main St.
Roscoe, IL 61073

SmithKline Animal Health Products
P.O. Box 2650
West Chester, PA 19380

The Stearns Tech. Textile Co.
100 Williams St.
Cincinnati, OH 45215

3M/Medical-Surgical Div.
225-5S-01
3M Center
St. Paul, MN 55144-1000

Universal Milking Machine Div.
Universal Coops, Inc.
Dairy Equipment Dept.
P.O. Box 460

Minneapolis, MN 55440

Walker Stainless Equipment Co.
601 State St.
New Lisbon, WI 53950

Dairy and Food Sanitation (ISSN:0273-2866) is published monthly by the International Association of Milk, Food and Environmental Sanitarians, Inc., executive offices at PO Box 701, 502 E. Lincoln Way, Ames, IA 50010. Printed by Heuss Printing, Inc., 911 Second St., Ames, IA 50010. **Second-class postage paid at Ames, IA. Postmaster: Send address changes to IAMFES, 502 E. Lincoln Way, Ames, IA 50010-0701.**

Manuscripts: Correspondence regarding manuscripts and other reading material should be addressed to Kathy Hathaway, PO Box 701, Ames, IA 50010-0701. 515-232-6699.

"Instructions to Contributors" can be obtained from the editor.

Orders for Reprints: All orders should be sent to IAMFES, Inc., PO Box 701, Ames, IA 50010-

0701. Note: Single copies of reprints are not available from this address; address reprint requests to principal author.

Business Matters: Correspondence regarding business matters should be addressed to Kathy R. Hathaway, IAMFES, PO Box 701, Ames, IA 50010-0701.

Subscription Rates: \$60.00 per volume, one volume per year, January through December. Single copies \$6.00 each. No cancellations accepted.

Sustaining Membership: A sustaining membership in IAMFES is available to companies at a rate of \$300 per year, which includes \$100 credit toward an ad in the "annual meeting issue" of the Journal, the July issue. For more information, contact IAMFES, PO Box 701, Ames, IA 50010-

0701, 515-232-6699.

Membership Dues: Membership in the Association is available to individuals only. Direct dues are \$28.00 per year and include a subscription to **Dairy and Food Sanitation**. Direct dues and both journals are \$50.00. Affiliate and International Membership include both journals for \$50, plus affiliate dues. Student membership is \$14.00 per year, with verification of student status, and includes Dairy and Food Sanitation. No cancellations accepted.

Claims: Notice of failure to receive copies must be reported within 30 days domestic, 90 days foreign. All correspondence regarding changes of address and dues must be sent to IAMFES, Inc., PO Box 701, Ames, IA 50010-0701, 515-232-6699.

IAMFES
OFFICERS AND EXECUTIVE BOARD

President, SIDNEY BARNARD, 9 Borland Lab, Pennsylvania State University, University Park, PA 16802.

President-Elect, ROY GINN, Dairy Quality Control Inst., 2353 No. Rice St., Room 110, St. Paul, MN 55113.

Vice-President, LEON TOWNSEND, Milk Control Branch, Bureau for Health Services, 275 East Main St., Frankfort, KY 40601.

Secretary, ROBERT GRAVANI, 8A Stocking Hall, Cornell University, Ithaca, NY 14853.

Past-President, ARCHIE C. HOLLIDAY, VA Dept. of Ag., 1100 Bank St., Room 511, Richmond, VA 23219.

Affiliate Council Chprn., HELENE UHLMAN, 1532 W. 4th Place, Hobart, IN 46342.

EDITORS

KATHY MOORE HATHAWAY, *Editor and Executive Manager*, Box 701, Ames, Iowa 50010

SUZANNE TRCKA, *Associate Editor*, Box 701, Ames, Iowa 50010

HENRY ATHERTON, *Technical Editor*, University of Vermont, Carrigan Hall, Burlington, VT 05405.

EDITORIAL BOARD

K. ANDERSON Ames, IA
H. V. ATHERTON Burlington, VT
K. J. BAKER Rockville, MD
S. BARNARD University Park, PA
H. BENGSCHE Springfield, MO
F. BODYFELT Corvallis, OR
J. BRUHN Davis, CA
J. BURKETT Sioux City, IA
J. CHAMBERS West Lafayette, IN
W. CLARK Chicago, IL
W. W. COLEMAN St. Paul, MN
O. D. COOK Rockville, MD
R. DICKIE Madison, WI
F. FELDSTEIN Culpeper, VA
R. FUQUA Mt. Juliet, TN
J. GERBERICH Eau Claire, WI
P. HARTMAN Ames, IA
C. HINZ Le Roy, NY
C. JELLINGS Clinton, IA
D. JOLLEY Bradenton, FL
W. LAGRANGE Ames, IA
J. LITTLEFIELD Austin, TX
J. MIRANDA Los Angeles, CA
D. NEWSLOW Orlando, FL
D. PEPER Sioux City, IA
M. PULLEN St. Paul, MN
J. REEDER Arlington, VA
D. ROLLINS Springfield, MO
R. SANDERS Washington, DC
P. C. VASAVADA River Falls, WI
E. O. WRIGHT Bella Vista, AR

Dairy and Food Sanitation

CONTENTS Vol. 6 No. 8 August, 1986

MEMBERSHIP APPLICATION FORM 325

ARTICLES:

• **Salmonella in Cooked Beef:
An Update** 328
Mr. Ralph Johnston

• **An Evaluation of the Precision of
Reference Test Methods Used in the
Analysis of Milkfat in Laboratory
Control Samples** 332
*Vernal Packard, Roy E. Ginn, Dennis Gulden and
Edward Arnold*

NEWS AND EVENTS 336

- Dr. Elmer H. Marth Receives 1986 Borden Award
- 1985 Dry Milk Census Now Available
- Seafood Videotape Now Available from NIFI

**** and more ****

NEW PRODUCT NEWS 342

FOOD SCIENCE FACTS 344
• Cockroaches

FOOD AND ENVIRONMENTAL HAZARDS TO
HEALTH 346

AFFILIATE NEWSLETTER 349
• Illinois, Texas and Florida Highlights

NEW MEMBERS 351

IAMFES AFFILIATE OFFICERS 353

BOOK REVIEWS 356

BUSINESS EXCHANGE 359

JFP ABSTRACTS 365

READER SERVICE PAGE 369

CALENDAR 372

Salmonella in Cooked Beef: An Update

Mr. Ralph Johnston, Director

Microbiology Division
Science, Meat & Poultry Program Inspection
USDA-FSIS
Washington, DC 20250

Presented at the ABC Research Corp. 12th Annual Seminar

I am pleased to have the opportunity to speak to you today on the *Salmonella* in cooked beef issue. Frequently, I have to talk about current problems or potential problems, but I believe that today we can look at the efforts of Government and Industry to control *Salmonella* in cooked beef as a huge success from the standpoints of the consumer, the Government and the Industry. This is not to say that all of the problems are completely solved. However, we can say that from a national perspective, this industry, prodded by FSIS, has made tremendous strides in technology, controls and concern for the safety of the product it produces.

Many of you are aware of the background of this problem, but for review and the benefit of those who are not, I will summarize this.

In the late 1960s, the production of cooked and roast beef began to move from small delis to small specialized processors of corned beef, roast beef and cooked beef. The new firms came under Federal inspection and many of these had little technical knowledge and their equipment was marginal. At about the same time, FSIS approved the pumping of beef with solutions of flavoring agents. The pumped product was preferred by customers, permitted processors to develop unique flavors, provided an economic advantage because of the added water and distributed surface bacteria to the core of beef rounds. FSIS had no cooking requirements for beef at that time since no problems had been perceived and there was a preference of many consumers for very rare beef. The prevailing attitude for beef was that one could sear the surface to destroy surface bacteria and safely consume the dish. This attitude prevailed amongst chefs, the industry and even scientists and historically, there was little or no epidemiological data to question it. *Salmonella* was a problem of poultry, pork or human carriers.

An outbreak of human salmonellosis from roast beef occurred in the New York area in 1969. The product was prepared from imported beef, and was nearly raw in the core. The firms sanitation was poor. The product was re-

called, and the firm was closed until many improvements were made. Other outbreaks occurred in 1971, 1974, two or three in 1975, and another in 1977. All of these were in the northeast and occurred in the late summer or early fall when the weather was hot. In 1977, FSIS passed emergency legislation requiring cooked beef to be heated to an internal temperature of 145°F. While the industry had done little, during this period, to improve the situation, they reacted strongly to the emergency regulation. Dr. Angelotti told the group that if they didn't like the regulation, they should provide data to support something different. We had not been able to find such information and the industry couldn't either. They did organize a coalition of trade groups to support a joint USDA/ABC Research Laboratory protocol to develop the data. The protocol was developed and ABC conducted the work. FSIS had added a new dimension to the protocol. We had inoculated *Salmonella* heavily both into the core and onto the surface of beef rounds, at our Beltsville laboratory, and cooked these to 145°F internal. We observed, as anticipated, the complete destruction of *Salmonella* in the core but survival of some on the surface. It is well known that *Salmonella* become more heat resistant when they are dry and it was hypothesized that this was the cause of survival in our dry kitchen range cook.

ABC Research did an outstanding job of rapidly completing the research called for in a comprehensive protocol. This work became the basis for the 1978 cooked beef regulations, which permit the use of 15 different combinations of temperature and holding times. Each provides an equal 7D destruction of *Salmonella*. Humidity and oven temperature were also incorporated into the regulation. This regulation is one of the most progressive ever written by FSIS. It provides for the production of a safe product, permits flexibility within industry and allows for the safe production of an extremely rare beef product for those who want it. The system worked fine for a couple of years and we reduced our testing frequency. In 1981, another sizeable outbreak occurred in the northeast. Our investigation into this incident showed

that the firm had significant post processing sanitation problems and that the separation of raw and cooked meat areas was inadequate. Health officials and epidemiologists from nine northeastern states reacted to this incident with a 21 point petition to the administrator of FSIS which essentially questioned the accuracy of the ABC research, the FSIS regulations and called for doing it over again. We prepared information and data that refuted the majority of these points and agreed totally with a couple of them. We knew that we had to rewrite the regulation to explicitly describe requirements for separation of raw and cooked product, record keeping, cooling and a whole host of peripheral concerns. These would be followed by both inspectors and processors. This was done, our inspectors were provided with training in the area and told not to permit any deviations from the regulations. Our laboratories increased their surveillance and review teams inspected plants to verify that the regulations were being enforced. No further outbreaks have occurred since that one in 1981, so there has been only one outbreak since the 1978 regulation. We have had several recalls based upon the testing program, however, these appear to be beneficial in that we are detecting problems before they cause illnesses.

Currently, one can assess the situation as follows:

- The regulations are sound; the cooking permitted kills *Salmonella*.

- Humidity is a critical control factor for rounds of beef cooked without a bag. We suspect that it is equally critical in producing other food products safely but is not always recognized.

- Packaging of cooked beef needs to be accomplished in an almost aseptic manner which is not too well understood by those who do it.

- While technology has improved in many establishments, most still have no employees scientifically trained to assure compliance.

- Preoperational sanitation is essential. If equipment is cleaned at the end of a days shift and any area is missed, *Salmonella* can grow to enormous numbers during the night, particularly in the warm weather. Operators fail to see this aspect. We still see clean-up at the end of a shift and pack off of cooled, cooked rounds the following morning without recleaning or sanitizing.

- FSIS must continue to monitor these products heavily and indefinitely. Government testing keeps establishments aware of the need to follow the regulations. Our inspectors will "test" at the slightest deviation.

I thought you might like some statistics for our testing programs. We have two programs for cooked beef products, one is a surveillance program for firms producing over 40,000 pounds per month where monthly samples are taken through computer selection. The second program is designed for smaller producers, these are sampled every 2 or 3 months again by computer selection.

When a plant is sampled, we take a center slice approximately 1/2" thick from each product available that day such as cooked beef, roast beef and corned beef.

Each sample weighs approximately 200 grams and the entire sample is tested for *Salmonella* and *E. coli*.

Surveillance Program
July 1, 1983 through November 30, 1985

	<i>E. coli</i>	<i>Salmonella</i>
Cooked Beef	125/500	1/502
Roast Beef	98/417	2/419
Corned Beef	127/507	1/510
TOTAL	350/1424	4/1431

Monitoring Program
July 1, 1983 through November 30, 1985

	<i>E. coli</i>	<i>Salmonella</i>
Cooked Beef	116/551	0/553
Roast Beef	99/399	2/402
Corned Beef	135/544	1/549
TOTAL	350/1494	3/1504

This information tells us that the *Salmonella* problem in cooked beef has been reduced to an extremely low level. I'm not sure we can completely eliminate it and certainly the *E. coli* results show that there remains a potential that has to be controlled by constant industry and government vigilance. This is a tough sampling and testing program, the sample size is large and even the *E. coli* determination is an enrichment *E. coli* for the total sample. This is our innovation and it appears that we are measuring plant sanitation at a level of sensitivity not heretofore used.

Packaging, rebagging, trimming, etc., of properly cooked beef requires controls as stringent as those called for in processing. Unfortunately, it is one that deals with people and perceptions of sanitation. We can't measure human performance like we can oven performance. It must be done in a different way, and must be a continual process since new workers commonly enter the picture. The importance of employee knowledge and compliance with historic principles of sanitary handling of cooked beef cannot be over emphasized. Further, this statement applies not just to cooked beef but to most ready-to-eat prepared products including meat, poultry, fish, dairy products, etc.

In conclusion, the regulations are sound, the research was sound but until automation replaces the employee, food plant sanitation must be recognized as highly variable and in many instances a weak link that could lead to product involvement in human illnesses, recalls and other unpalatable consequences. Effective employee and

plant sanitation techniques are old-tech and inexpensive to attain. They are also frequently neglected or not strongly supported by management. Microbes patiently await their opportunity to attack. Historically, when given the opportunity, they can create as much mayhem in

1986 as they did in past decades or even centuries. We need our high tech ovens and packaging machinery but old-tech plant sanitation remains essential to the modern food processing plant.

MICROBIOLOGICAL MONITORING PROGRAM
Cooked and Roast Beef/Cooked Corned Beef (MM-9)

	No. Plants Sampled	<i>E. coli</i> No. Pos./No. Tested	<i>Salmonella</i> No. Pos./No. Tested
<i>November 1 - 30, 1985</i>			
Cooked Beef		4/15	0/15
Roast Beef		2/14	0/19
Cooked Corned Beef		6/19	0/14
Total	37	12/48	0/48
<i>Fiscal Year 1984</i>			
Cooked Beef		53/234	0/236
Roast Beef		37/142	0/145
Cooked Corned Beef		46/205	1/210
Total	427	136/581	1/591
<i>Fiscal Year 1985</i>			
Cooked Beef		37/218	0/218
Roast Beef		41/181	2/181
Cooked Corned Beef		45/230	0/230
Total	468	123/629	2/629
<i>Fiscal Year 1986</i>			
Cooked Beef		8/36	0/36
Roast Beef		6/30	0/30
Cooked Corned Beef		15/39	0/39
Total	79	29/105	0/105
<i>Cumulative Total Samples</i>			
<i>July 1, 1983 to Present</i>			
Cooked Beef		116/551	0/553
Roast Beef		99/399	2/402
Cooked Corned Beef		135/544	1/549
Total	1105	350/1494	3/1504

MICROBIOLOGICAL SURVEILLANCE PROGRAM
Cooked and Roast Beef/Cooked Corned Beef (Tumbled/Massaged) (MS-3)

	No. Plants Sampled	<i>E. coli</i> No. Pos./No. Tested	<i>Salmonella</i> No. Pos./No. Tested
<i>November 1 - 30, 1985</i>			
Cooked Beef		4/17	0/19
Roast Beef		2/14	0/15
Cooked Corned Beef		2/20	0/21
Total	31	8/51	0/55
<i>Fiscal Year 1984</i>			
Cooked Beef		35/158	0/158
Roast Beef		38/127	0/128
Cooked Corned Beef		45/177	0/179
Total	292	118/462	0/465
<i>Fiscal Year 1985</i>			
Cooked Beef		62/271	1/271
Roast Beef		45/220	2/220
Cooked Corned Beef		57/234	1/234
Total	443	164/725	4/725
<i>Fiscal Year 1986</i>			
Cooked Beef		5/29	0/31
Roast Beef		2/24	0/25
Cooked Corned Beef		5/35	0/36
Total	55	12/88	0/92
<i>Cumulative Total Samples July 1, 1983 to Present</i>			
Cooked Beef		125/500	1/502
Roast Beef		98/417	2/419
Cooked Corned Beef		127/507	1/510
Total	881	350/1424	4/1431

QUALITY USED EQUIPMENT

Homogenizers 15 - 5,000 GPH
 Centrifugal / Positive Displacement Pumps
 Pasteurizers / Processors / Kettles 25-1,000 Gal.
 Disintegrators / Hammer Mills / Concentrate Breakers
 Plate / Tubular / Swept Surface Heat Exchangers

WANTED — YOUR USED EQUIPMENT — WANTED

EQUIPMENT SPECIALISTS INC.

7793 NW 32 St. Miami, Florida 33122
 Telephone (305) 591-8484 TLX 263873

Please circle No. 124 on your Reader Service Page

An Evaluation of the Precision of Reference Test Methods Used in the Analysis of Milkfat in Laboratory Control Samples

VERNAL PACKARD¹, ROY E. GINN², DENNIS GULDEN³ and EDWARD ARNOLD³

INTRODUCTION

The advent of infra-red analysis of milk has introduced a variety of analytical issues heretofore unencountered in the dairy industry. Such devices require calibration against reference methods and then continuous monitoring of calibration, also against reference methods. Either individual plants must maintain the equipment and skilled technicians to regularly perform the reference analyses on control milk samples, or an independent laboratory must provide control samples for these laboratories. The latter is not only less costly, it has also been found to significantly lower between-plant variation in test results (4). However, maximum reduction in test variation requires that reference tests applied to control samples exhibit the highest possible degree of precision (repeatability). At the same time, if more than one method is approved as suitable for reference testing, it becomes necessary to know how well such methods agree with each other. Evidence in the scientific literature suggests some differences between the Babcock and Mojonnier results (2, 3, 5, 6, 7, 8). Not only do the two procedures differ, but also the magnitude of the difference appears

to increase with increasing fat content (4, 5, 7).

The need for a high degree of precision and agreement between methods becomes that much more important in preparation of control samples used by laboratories in the calibration and monitoring of infra-red equipment. With this in mind, the study reported herein was undertaken to assess both the relative precision of reference methodologies used in preparation of control samples by Dairy Quality Control Institute, Inc., and also to evaluate differences between the Babcock and Mojonnier methods. In addition, it seems desirable to begin to assess reference methods in terms of the unique requirements for their application to control samples.

MATERIALS AND METHODS

On a regular basis, Dairy Quality Control Institute, Inc. collects farm samples of raw milk and conducts reference test analyses on them. These samples are then minimally preserved with potassium dichromate and distributed to various dairy laboratories as "control" samples for calibration and monitoring of infra-red milk testing instruments. These samples now number 12 per set and range in milkfat test from about 2.5 to 6.0%.

Twelve lots of milk widely varying in composition were assembled each week. Two samples were taken from each lot and randomly ordered for presentation to technicians. Hence, each set consisted of 12 samples in

blind duplicate. One such set was retained by Dairy Quality Control Institute, Inc., the other delivered to Land O'Lakes, Inc. for testing purposes. In total, six such sets were tested by each laboratory over a six-week period ($12 \times 2 \times 6 = 144$ observations per laboratory).

Babcock analyses were conducted by two different technicians employed by Dairy Quality Control Institute, Inc. One technician in this same laboratory also performed Mojonnier analyses. This latter method was also applied by a technician at Land O'Lakes, Inc. Laboratories in Arden Hills, Minnesota. Mojonnier analyses were conducted as described in Standard Methods for the Examination of Dairy Products, 15th edition (9). The Babcock method was somewhat modified from "Standard Methods" procedure. Specific changes and/or conditions of running the test included (a) an adjustment of milk temperature to 15.5°C (60°F), (b) adjusting of the specific gravity of the sulfuric acid to 1.825, (c) adjusting acid to 17.7°C (64°F) prior to addition to milk, and (d) the addition of precisely 17.5 ml of the acid to milk samples.

RESULTS AND DISCUSSION

Table 1 gives evidence of the relative precision (repeatability) of the Babcock and Mojonnier analyses. Under the testing method used in Dairy Quality Control Institute, Inc., the Babcock test appears to be only slightly less precise than the Mojonnier

¹Department of Food Science and Nutrition, University of Minnesota, 1334 Eckles Avenue, St. Paul, Minnesota 55108.

²Dairy Quality Control Institute, Inc., 2353 Rice Street, St. Paul, Minnesota 55113.

³Land O'Lakes, Inc., P.O. Box 116, Minneapolis, Minnesota 55440.

nier. The standard deviation of the difference of blind duplicate Babcock analyses was 0.0402 and 0.0442 for two different technicians, and 0.0166 and 0.0325 for Mojonnier analyses as conducted in each of two laboratories. In addition, the differences in test results were not statistically significant ($p < .05$) within or between technicians for the Babcock test nor within or between laboratories for the Mojonnier analysis. On single tests of the samples, after correction for bias, infra-red analyses showed a mean difference of 0.0097 and a standard deviation of the difference of 0.0385 between two instruments operated within the same laboratory. Overall, these data suggest that careful attention to methodology, along with steps designed to maximize consistency in Babcock testing, can produce a degree of repeatability in the

Babcock test not greatly different from the Mojonnier.

In Table 2 are shown the differences in overall average values of each method. The averages reflect 72 samples analyzed in blind duplicate over a range of 2.45 to just over 6% fat. Two technicians produced mean values of 4.206 and 4.204% using the Babcock test. It should be noted that these values differ only in the third decimal point, and then only by 0.002%. Once again, the data reflect the consistency possible in this method. Average values for Mojonnier analyses were 4.189 and 4.193% for each of two different laboratories. Hence, between-laboratory averages agreed to within 0.004%. This was just slightly better than single test averages obtained on the two infra-red testers operating in the same laboratory. In the latter, the means differed by 0.01%.

However, the data also show that the Babcock test produced consistently higher results than the Mojonnier, in this case ranging from 0.011 to 0.017% higher for two different Babcock technicians. Whether considered separately or combined, average data of the two Babcock technicians differed from comparable Mojonnier results to a statistically significant degree ($p < 0.05$).

Not only do differences in test results exist, the magnitude of the difference increases with increasing level of fat in the milk. Again, this is not a new fact of the scientific literature. However, it is fact, and Table 3 provides evidence of it. These data show the difference between the two tests for the lower and higher testing samples as divided at mid-range by the computer. The latter accounts for the slight overlap in range values. Babcock data of technicians 1 and 2 were taken in the same laboratory as Mojonnier data of laboratory 1. If these results are compared, only within-laboratory variations are reflected. In this case, Babcock results of samples ranging from about 2.45 to 4.1% differed from the Mojonnier results by 0.004 and 0.007%, respectively, for the two technicians. For samples ranging in fat content from about 4.1 to 6.2%, these differences went from 0.03 to 0.015%, or between two to three times higher than those of lower fat content. Although the percentages are small and the data well within values reported in the scientific literature,

TABLE 1. Precision of the Babcock^(a), Mojonnier^(a), and Infra-red^(b) Methods on Raw Milk Samples.

Test Method	Mean (%)	Mean Difference	S.D. Difference
<i>Babcock:</i>			
Tech 1	4.206	.0014	.0402
Tech 2	4.204	.0042	.0442
Between-Tech		.0021	.0386
<i>Mojonnier:</i>			
Lab 1	4.189	.002	.0166
Lab 2	4.193	.0032	.0325
Between-Lab		.0038	.0198
<i>Infra-red:</i>			
Between-Inst.		.0097	.0385

^(a)Results were obtained on 72 samples analyzed in blind duplicate by this method.

^(b)Results represent single analyses of 12 samples on two instruments after correcting for bias.

TABLE 2. Difference Between Babcock, Mojonnier, and Infra-red Analyses^(a).

Method	Mean (%)	Difference		
		Babcock-Mojonnier	Babcock-IR ^(b)	Mojonnier-IR ^(b)
<i>Babcock:</i>				
Tech 1	4.206	.017 (Lab 1)	.012 (IR 1)	-.005 (IR 1)
		.013 (Lab 2)	.002 (IR 2)	-.015 (IR 2)
Tech 2	4.204	.015 (Lab 1)	.01 (IR 1)	-.001 (IR 1)
		.011 (Lab 2)	0.0 (IR 2)	-.011 (IR 2)
<i>Mojonnier</i>				
Lab 1	4.189			
Lab 2	4.193			
<i>Infra-red:</i>				
Inst. 1	4.194			
Inst. 2	4.204			

^(a)Results are based on 72 raw milk samples analyzed in blind duplicate by Babcock and Mojonnier methods and single infra-red analyses of 12 control samples after the instrument was corrected for bias.

^(b)Abbreviation for Infra-red instrument, number 1 or 2.

TABLE 3. *Difference Between Babcock and Mojonnier Methods at Relatively Low and Relatively High Levels of Fat in Raw Milk.*

Tech No.	BABCOCK			Lab No.	MOJONNIER			Difference Babcock-Mojonnier (%)
	Range	Mean (%)	N ^(a)		Range	Mean (%)	N ^(a)	
1	2.475-4.1	3.392	36	1	2.45 -4.16	3.338	36	.004
	4.15 -6.2	5.021	36		4.119-6.179	4.991	36	.03
2	2.45 -4.15	3.395	36	2	2.453-4.121	3.388	36	.007
	4.075-6.15	5.013	36		4.136-6.161	4.998	36	.015
1 and 2 combined	2.45 -4.15	3.394	72		2.45 -4.16	3.388	72	.006
	4.075-6.2	5.017	72		4.119-6.179	4.9945	72	.0225

^(a)Numbers of samples analyzed in blind duplicate (i.e., 72 observations). The combined samples reflect means of two technicians and two laboratories, each totaling 72 samples analyzed in blind duplicate (i.e., 144 observations).

the ramifications are obvious. Furthermore, if between-laboratory variations are considered, the differences tend to mount in magnitude. For example, the high testing samples differed by 0.0225% when the results of two laboratories doing Mojonnier analyses were compared to the combined results of two technicians conducting Babcock tests.

In general, data from this study suggest that reference fat test results on control samples used for calibration and monitoring of infra-red instruments can achieve a precision, on duplicate analyses, of mean differences in significant figures out to the third decimal point. No values were as high or higher than 0.005. As for standard deviation of the difference, both the Babcock and Mojonnier methods gave results under 0.05, although the former was in fact somewhat less precise than the latter in this regard. For future consideration, it seems also noteworthy that Babcock and Mojonnier results do differ in statistically significant degree, and that such differences widen at higher fat tests. At some point, such differences will have to be resolved in terms of their application to control sample testing.

REFERENCES

- Association of Official Analytical Chemists. 1984. Official methods of analysis. Sidney Williams, ed. Washington, D.C.
- Hileman, J. L., K. K. Rush and C. Moss. 1942. The relationship of errors in the Babcock test to losses in cream plants. *J. Dairy Sci.* 25:373.
- Marshall, R. T. 1985. Means differ by .051% in collaborative study of Babcock and ether extraction methods. *J. Dairy Sci.* 68:1642.
- Michalak, W., H. Cynalewska and H. Oczkowicz. 1978. Collaborative testing among laboratories routinely testing fat and protein in milk. *J. Dairy Sci.* 61:1634.
- Moore, J. M., S. Russell and N. J. Pelsue, Jr. 1974. Comparisons of the Babcock and Roese-Gottlieb methods for determining butterfat in milk. *J. Assoc. Off. Anal. Chem.* 57:39.
- O'Dell, W. T. 1961. Comparison of acid and nonacid volumetric methods for determining the percentage of butterfat in raw milk. *J. Dairy Sci.* 44:47.
- Packard, V. S., R. E. Ginn and J. R. Rosenau. 1973. A comparison of the Babcock, Mojonnier, and Milkotester Mark III methods in the analysis of milkfat in cream. *J. Milk Food Technol.* 36:523.
- Randolph, H. E., T. V. Armstrong and I. A. Gould. 1960. Variations in fat test results as related to the fat content of fluid milk products. *Milk Dealer.* 49:30.
- Richardson, G. H. (ed.). 1985. *Standard Methods for the Examination of Dairy Products*, 15th ed. American Public Health Association, Washington, D.C.



SILIKAL STOPS FLOOR DELAMINATION

SILIKAL R61-HW TOPPING CONQUERS HIGH THERMAL SHOCK PROBLEMS

- FDA/USDA approved...not an epoxy.
- Self-bonding acrylic resin formula has high elasticity - adheres better to concrete and other substrates.
- Cures in 1 hour to full strength - superior resistance to impact, heat shock, chemicals.
- Skid resistant - perfect for frequent "wash-downs"; choice of colors, too.
- Easy to clean - will not harbor bacteria.
- Long lasting - pays for itself rapidly.
- Backed by 25 years of experience, world-wide.

Send for **FREE** Technical Data.

Silikal® **SILIKAL NORTH AMERICA, INC.**
 305 Sniffens Lane, Stratford, CT 06497
 TEL: (203) 377-5500 TX: 4757013-SILIKA

Please circle No. 123 on your Reader Service Page

Meeting Your Testing Needs

FOOD & DAIRY

MICROBIOLOGICAL
VITAMIN MINERAL
GENERAL CHEMICAL
PROXIMATE PESTICIDE

ENVIRONMENTAL

WATER & WASTEWATER ANALYSES
HAZARDOUS WASTE SLUDGE
PRIORITY POLLUTANT ANALYSES
GROUNDWATER MONITORING
VOLATILE ORGANICS



**MINNESOTA VALLEY
TESTING LABORATORY, INC.**

326 Center St.
New Ulm, MN 56073
or
328 Chester St.
St. Paul, MN 55107

Please circle No. 147 on your Reader Service Page

Please circle No. 111 on your Reader Service Page

END BIRD POLLUTION!

with environmentally safe
"silent sound" birds hate.

Birds can be hazardous to plant production, warehousing, and profits, yet you can stop contamination safely with ULTRASON!
Circle an 8,000-sq. ft. area every 30 seconds with ever-changing ultrasonic sound people can't hear and birds can't tolerate. Maintenance-free, portable unit plugs into any 115-volt outlet. Get facts now.

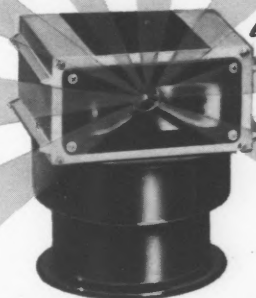

BIRD-X 

**BIRD CONTROL
SPECIALISTS**

730 W. Lake St., Chicago, IL 60606 • Call 1-312-648-2191

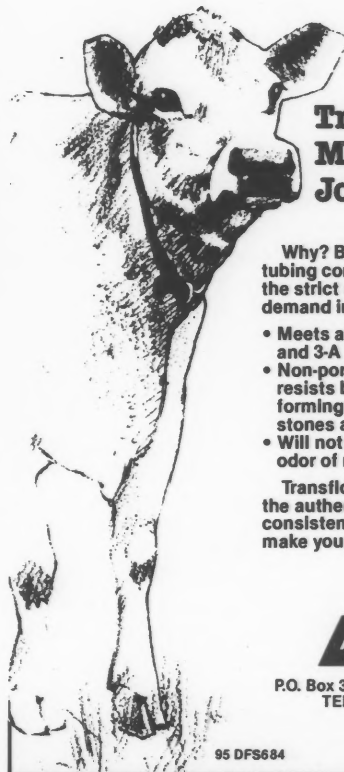

Transflow® Makes Your Job Easier!

Why? Because Transflow tubing consistently meets all the strict standards you demand in dairy tubing.

- Meets all applicable FDA and 3-A Sanitary Standards.
- Non-porous inner surface resists build-up of bacteria forming butterfat, milk stones and milk soil.
- Will not affect the taste or odor of milk.

Transflow tubing. Look for the authentic *Blue Stripe*®! Its consistent, high quality will make your job easier.

NORTON

P.O. Box 350, Akron, Ohio 44309
TEL: (216) 798-9240

95 DFS684

©NORTON CO. 1984

Please circle No. 129 on your Reader Service Page
DAIRY AND FOOD SANITATION/AUGUST 1986



Dr. Elmer H. Marth

Dr. Elmer H. Marth Receives the 1986 Borden Award

The American Dairy Science Association (ADSA) at its 81st annual meeting presented the Borden Award for 1986 to a scientist who has had a life-long love affair with the State of Wisconsin. Elmer Herman Marth was born in Jackson, Wisconsin in 1927 and earned his BS, MS and PhD degrees in bacteriology from the University of Wisconsin. Following completion of his PhD in 1954, he remained at Wisconsin as an instructor in microbiology. In 1957, Dr. Marth left Wisconsin to begin a nine-year affiliation as a research microbiologist with the Research and Development Division of Kraft, Inc. In 1966, he returned to the University of Wisconsin as an associate professor in the Department of Food Science, with joint appointments in the Department of Bacteriology and the Food Research Institute. In 1971, he was promoted to his current position as Professor of Food Microbiology. In addition to directing an active research program, Elmer Marth is actively involved in the dairy and food microbiology teaching program. Many of the pre- and post-doctoral students who have been trained in his laboratory have become frequent contributors to the primary literature in dairy and food microbiology.

With this award Dr. Marth is being honored for his extensive contributions in the areas of microbial quality and healthfulness of dairy foods over the past ten years. Throughout his career, Marth has shown keen foresight in selection of research problems with high scientific potential and which have had direct relevance to the needs of the dairy industry. For example, by the time that *Listeria* contamination of milk products surfaced as a major public health problem in 1985, he had already established a major research program in this area. Dr. Marth and his many students have made substantial contributions to our knowledge in many other areas, including mycotoxin contamination of dairy products, reduced cheese yields caused by proteolytic activity of psychrotrophic microorganisms in milk, recognition that certain molds may degrade sorbic acid added to cheese and other foods as an antifungal agent, establishment of conditions which retard

growth of staphylococci in cheese, and use of lactobacilli to degrade bitter peptides which commonly accumulate during accelerated aging of cheese. Full description of these and the many other related contributions of Dr. Marth would require a treatise-sized citation. These contributions are detailed in over 150 primary research articles published by Dr. Marth during the past ten years.

In addition to his intensive commitment to research and student training, Elmer Marth manages to find time to be an active member of a number of professional organizations. In addition to his many contributions to programs and activities of the American Dairy Science Association, for the past ten years he has served as editor of the *Journal of Food Protection*, a publication of the International Association of Milk, Food and Environmental Sanitarians, and has edited the 14th edition of *Standard Methods for the Examination of Dairy Products* for the American Public Health Association.

This award is a fitting honor for a scientist who has been a recognized leader in dairy microbiology for three decades. In a sense, receipt of the 1986 Borden Award completes an ADSA hat trick for Dr. Marth, who received the Association's Pfizer Award in 1975 and the Dairy Research Foundation Award in 1980.

The excellence of his research has also been recognized by the International Association of Milk, Food and Environmental Sanitarians with the Educator and Citation awards given to Dr. Marth in 1977 and 1984, respectively, and by the American Cultured Dairy Products Institute with the Nordica Award given to him in 1979. Dr. Marth was elected a Fellow of the Institute of Food Technologists in 1983, and has been a Registered Sanitarian in the State of Wisconsin since 1975.

Sodium Label Regulations Took Effect in July

Consumers should find it a little easier to cut back on sodium in their diets, thanks to a new Food and Drug Administration (FDA) regulation, says a Texas A&M University Agricultural Extension Service nutritionist.

Beginning July 1, 1986, the FDA required that the sodium content be shown on any food that provides nutrition information on the label, reports Mary K. Sweeten.

"The regulation should be of a real help to people who are concerned about the hidden sources of sodium in processed foods," she says.

According to the nutritionist, sodium content will be listed in milligrams per serving. Consumers can use that information to see if they are staying within the recommended sodium intake of 1,100 to 3,300

milligrams a day.

In addition, Sweeten says the FDA has defined the various terms that manufacturers may use to describe the sodium content of their products. These terms include:

- "Sodium Free" -- less than 5 milligrams of sodium in each serving.
- "Very Low Sodium" -- 35 milligrams or less in a serving.
- "Low Sodium" -- 140 milligrams or less per serving.
- "Reduced Sodium" -- the usual level of sodium for this product has been reduced by at least 75 percent.

"Sodium-conscious consumers should keep in mind that a product with little or no salt is not necessarily sodium free," Sweeten cautions, "since at least 70 sodium compounds, such as monosodium glutamate or sodium bicarbonate, are used in processed foods."

But she also points out that an FDA survey shows about half the food products available would already qualify as being "low-sodium" products. Among these foods are hot and cold cereals, fresh meats and poultry, some fish, frozen vegetables, and some desserts and snacks.

Whole Milk May Protect Against Stomach Ulcers

Researchers may be closer to identifying an agent in whole milk that helps protect against stomach ulcers. Elizabeth J. Dial, Ph.D., and Lenard M. Lichtenberger, Ph.D., both from the University of Texas Medical School at Houston, said recent studies suggest a substance in milk fat, specifically the phospholipids, appears to be the protective agent found in whole milk.

The researchers summarized their findings during the Digestive Disease Week held May 17-21 at the Moscone Center in San Francisco.

In the study, researchers fed two groups of ulcer-prone rats a diet including either whole or skim milk. Rats fed whole milk, which has a higher fat content, suffered less stomach damage. Dial and Lichtenberger say findings indicate that a fat or lipid component in milk may protect the stomach by enhancing the stability of a defense layer on the stomach lining. This layer helps guard against ulcer-causing acids.

"Research has linked other components in milk such as calcium to aid in reducing the risk of high blood pressure and osteoporosis," said Elwood W. Speckmann, Ph.D., president of National Dairy Council. "Current research findings continue to show the importance of milk and of dairy foods to a well-rounded nutritious diet.

Research by Dial and Lichtenberger is being funded by the National Dairy Promotion and Research Board, and is administered by National Dairy Council.

National Dairy Council conducts nutrition research and nutrition education programs for United Dairy Industry Association. UDIA represents 95 percent of the nation's dairy farmers and 86 percent of milk marketed.

Kansas State University Appointment and Promotions

William G. Ikins, Post-Doctorate at Michigan State University, has been named Assistant Professor in Food Chemistry at Kansas State University in the Department of Animal Sciences and Industry. Dr. Ikins received his B.S. and M.S. degrees in Food Science at Michigan State University and his Ph.D. in Food Science and Toxicology also from MSU in 1986. In his new position, he will teach courses in Food Chemistry and Food Analysis. His research area is in N-nitrosamine formation and inhibition in food systems. He will participate in research efforts in dairy food products and other food systems. He is a member of IFT.

Recently several KSU Food Science faculty members received academic promotions. Ike Jeon, dairy food product specialist, has been promoted to associate professor. Carole Setser, a sensory evaluation expert, and Joseph Zayas, an internationally known meat scientist, have been promoted to full professors.

The chairman of the interdepartmental food science graduate program at Kansas State University is Daniel Y. C. Fung and the chairman of the undergraduate program is Franklin E. Cunningham.

1985 Dry Milk Census Results Now Available

The American Dairy Products Institute, national trade association of the processed dairy products industry, is pleased to announce the availability of its "Census of 1985 Dry Milk Distribution and Production Trends", a yearly publication compiled by the Institute. This publication contains comprehensive industry data and reliably reflects domestic sales and specific markets of utilization for nonfat dry milk, dry whole milk, and dry buttermilk. Data on the utilization of concentrated forms of these milk products also are presented.

This industry-wide survey of the end-use of dry

milks distributed in 1985 is intended to serve as a guide in directing promotional efforts to continue the expansion of commercial markets for dry milks. Continued research and development of new uses for the various concentrated and dry milks are necessary for full expansion of this segment of the dairy industry and represents a program objective of the Institute.

This publication is available for purchase at \$4.00 per copy; for further information contact the American Dairy Products Institute, 130 North Franklin Street, Chicago, IL 60606. Telephone: (312) 782-4888.

Abstracts of Guidelines Prepared by Task Committees of the Northeast Dairy Practices Council

Guidelines on Stray Voltage on Dairy Farms — NDPC 42 (Revised February 1986) Single Copy \$2.00.

Abstract: This guideline contains basic information on stray voltage (properly known as neutral-to-earth voltage) on dairy farms - possible causes, troubleshooting and methods of correction.

Guidelines for the Potable Water on Dairy Farms — NDPC 30 (Revised March 1986) Single Copy \$3.00.

Abstract: This guideline is written for regulatory officials, sanitarians, cooperative extension agents, engineers and others who are advising dairy farmers on potable water supplies in the northeastern states. This material will assist the reader in evaluating existing water supplies and in the approval of new systems. Specific discussion, including tables and diagrams are provided to: evaluate existing water quality problems; find probable causes and possible solutions; locate and construct new water sources; interpret laboratory reports; provide water treatment; understand backflow prevention; and give common sense reasons why violations can create hazards and provide some acceptable options to make needed corrections.

Guidelines for Cleaners and Sanitizers for Dairy Farms — NDPC 20 (Revised March 1986) Single Copy \$3.00.

Abstract: This guideline gives a general introduction about cleaners and sanitizers and includes a resolution about bulk handling of these products. It then provides a list of dairy farm cleaners, sanitizers, udder

washing compounds and teat dips marketed in the northeast.

To order Guidelines or to obtain a complete listing of current prices of approximately 50 NDPC Guidelines, write: Richard P. March, Exec. Sec'y., Northeast Dairy Practices Council, Cornell University, 142 Riley-Robb Hall, Ithaca, NY 14853-5701 or call 607-255-2471.

New Seafood Videotape Now Available from NIFI

"Handling and Evaluating Seafood" is a new, exciting, 20-minute videotape from the National Institute for the Foodservice Industry, which demonstrates how to use proper sanitation to protect the quality of several market varieties of seafood.

Among the subjects covered by the video are:

- The importance of featuring seafood -- marketing its popularity in diet, nutrition and health.
- Seafood's variety, versatility and convenience.
- Choosing and working with a responsible supplier.
- Procedures for receiving and storing major market forms of seafood:
 - Fresh
 - Frozen
 - Smoked
 - Canned
- Methods for evaluating the physical condition of seafood.
- Effective temperature control in preventing product deterioration.

The videotape is available in three convenient forms: ½" Beta, ½" VHS, and ¾" Umatic.

For more information contact: Educational Program Department, National Institute for the Foodservice Industry, 20 N. Wacker Drive, Suite 2620, Chicago, Illinois 60606; telephone 312/782-1703.

Preventive Sanitation and Food & Drug Compliance Workshop Sept. 29 - Oct. 1

THE HUGE' CO., INC. and its division, the American Sanitation Institute, will present another "Preventive Sanitation and Food & Drug Compliance Workshop" including EPA/FIFRA and Pesticide Updates.

The seminar will be held on September 29, 30, and October 1, 1986, at the Hyatt-Cherry Hill, New Jersey, seven miles east of Downtown Philadelphia.

This workshop is of special interest to Food Industry Plant Management, QA and QC Managers,

Directors of Sanitation, Sanitarians and Pest Control Operators.

Some of the speakers and their topics are as follows: Matthew Lewis from the FDA in Newark, NJ, will give the keynote address on "The FDA Mission Role and Policy Relating to Clients in the Food Industry". From the same FDA office, Leonard Fantasia's topic will be "FDA Enforcement Policies and Compliance Procedures". Edward Marshall, Bell Laboratories, Madison, Wisconsin, will speak on "Rodents in Food Plants and Warehouses". Dr. Rafael Pedraja, from the Kitchens of Sara Lee, will address two topics: "Corporate Responsibility" and "The Development and Refinement of a Preventive Sanitation Program". Representatives from the American Sanitation Institute (ASI), Dr. Joseph D. Foulk, Ph.D., R.S., Thomas L. Huger and Lawrence O'Brien, will also conduct a variety of presentations related to preventive sanitation.

Other topics of discussion will include pesticide labels, employee practices, sanitation hazards, and insect and bird control. A new topic will be added to this seminar on cleaning and sanitizing chemicals, their type, dilution, use and safety. Instruction in the above topics will be enhanced through the use of slides and films.

For further information and/or registration, call Christine Verplank toll-free at 800-325-3371 or 314-725-2555.

Certified Professional Food Sanitarian (CPFS) Testing Programs Revised — New Beverage Category Added

The nationally recognized, Food Sanitation Institute, EMA, "Certified Professional Food Sanitarian" (CPFS) certification testing programs, established in 1976, have been completely revised and updated. "As time has a way of changing things, as related to food sanitation, from operating procedures, chemical usage, to federal rules and regulations, the CPFS examinations were all reviewed and revised," reported CPFS/FSI/EMA committee chairman, Richard C. Liebong, CPFS, plant environmentalist, Gerber Products Company (Fremont, Michigan).

At the request of individuals within the beverage industry the CPFS committee created and established a new CPFS Beverage Examination Category. The "Certified Professional Food Sanitarian" voluntary certification program now consists of a two-part examination, the first consists of general type sanitation questions relating to all segments of the food sanitation profession. The second part is offered in eight specific categories of food processing -

beverage; baking and confectionary; warehousing; food services; grain processing; meat, poultry and frozen foods; dairy products, and canning.

Since the inception of the CPFS food programs hundreds of food "sanitarians" have availed themselves of this voluntary certification program that certifies professional food sanitarians. The established programs recognize both the academic and experience level of the applicant candidates and by examination and board review process credits accordingly. Both programs and CPFS examinations are reviewed by the U.S. Food and Drug Administration, as a fulfillment of the training requirements of Section 110.10(7c) of the Good Manufacturing Practices.

Eligibility

Applicant candidates are eligible for the certification examination if they meet one of the following requirements:

- a. A Bachelor's degree in public health sanitation or food technology and one year acceptable employment as a food sanitarian.
- b. A Bachelor's degree in related sciences and two years employment as a food sanitarian.
- c. Two years of training at an accredited college or trade school and three years employment as

USE THE READER SERVICE CARD

The Reader Service Page is for you. Use it to get more information about the products and services advertised in this issue.

IAMFES

a food sanitarian.

- d. High school graduate or equivalent and four years employment as a food sanitarian.

Maintaining Certification

The continuing education of food sanitation executives is essential to enable the industry to cope with rapidly changing conditions. Therefore, to remain certified within the CPFPS programs, a food sanitation executive must accumulate ten professional credits each three years. Professional credits for recertification can be accumulated any time during the three year certification period. For example, executives certified by examination and receiving a certificate in 1986 must have filed a record of 10 professional points by anniversary date 1989. The Certification Board has identified a wide variety of educational endeavors and leadership activities through which a certification may be maintained.

A complete descriptive booklet on the food industry "Certified Professional Food Sanitarian" voluntary certification program is available by contacting the Food Sanitation Institute, EMA, certification office at 1019 Highland Ave., Largo, FL 33540. Telephone 813/586-5710.

Du Pont Establishes Awards Competition

The Du Pont Company has established the "Du Pont Awards" for innovation in food and packaging technology. Sponsored by Du Pont in cooperation with the National Food Processors Association, the awards will recognize innovative new ideas in all aspects of food processing and packaging that expand the use of plastic materials in food packaging.

The competition will honor innovations in technology coming from any part of the food industry, including food processors, container makers, equipment manufacturers, primary materials suppliers, distributors and others who play a role in the development of food products packaged in plastics.

The awards competition will be conducted in cooperation with the National Food Processors Association, a non-profit scientifically based industry organization representing more than 600 food processors and suppliers to the industry, and winners will be announced at the NFPA convention, Jan. 24 to 28, 1987. The deadline for entries is Nov. 30, 1986.

Any new food product, package or process used in food production involving packaging with plastic materials and first marketed or put into commercial use in North America between July 1, 1986, and

Dec. 1, 1986, is eligible for the competition. Plastic materials must be an essential component of the final product package. However, innovations represented in competition entries may come from any part of the food industry, including processing or packaging converting technology and equipment, packaging materials and product marketing concepts.

Judging will be conducted by a panel of experts from the food processing and packaging industries, as well as industry suppliers, educators and members of the trade press.

Criteria for evaluating entries will include: improvements in flavor, taste, aroma, and appearance of the food product; making the product easier to use, safer, more nutritious, available to greater numbers of people, less expensive to make, buy or use; extending shelf life; reducing spoilage or waste; and improvements in product retailing.

To learn more about the "Du Pont Awards" or to obtain an entry form, call (302) 999-2525.

Bob Nissen Announces Retirement

Robert L. Nissen, Vice President of Sales, Ladish Co., Inc., Tri-Clover Division has announced his retirement.

Nissen became advertising manager of the Kenosha, WI based firm in 1951, and general sales manager in 1957. He held the position of vice president of sales since 1980. Nissen is the immediate past president of DFISA and was a member of the DFISA Board of Directors for eight years. He was also chairman of the technical committee, a group that reviews sanitary standards for food and dairy processing equipment.

In recent years, he has been actively involved in an international task committee, designed to encourage the establishment of international sanitary standards. He is also past president of the National Association of Dairy Equipment Manufacturers, and a member of the International Association of Milk, Food and Environmental Sanitarians (IAMFES).

Nissen plans to stay in the Kenosha area, and will remain active with the IAMFES.

ASTEC Announces Formation of New Division

Aseptic Technology Engineering Company (ASTEC) has announced the formation of a new division, ASTEC Development Company, to concentrate on the development of new technology and new markets for

ASTEC's products and services. V. R. Carlson, formerly President of ASTEC, has been named General Manager of this new division.

Glynn Hatley, formerly Executive Vice President, has been appointed President of ASTEC.

ASTEC, of Cedar Rapids, Iowa specializes in the design, engineering, and sale of products and plants for aseptic processing and packaging of food products.

"The Industry's Best": Theme for Food and Dairy Expo '87

"The Industry's Best" is the theme of Food & Dairy EXPO '87, scheduled for September 26-30 at

McCormick Place, Chicago. An exhibitors' prospectus is now available for those interested in participating in EXPO '87.

The prospectus includes extensive data about the show, its audience of food, dairy and beverage processing industry executives and space reservation and membership applications. To obtain a copy, contact the show sponsor, Dairy & Food Industries Supply Association, at 6245 Executive Boulevard, Rockville, MD 20852, Telephone (301) 984-1444, Telex 908706 DFISA ROVE.

John M. Martin, DFISA executive vice president, said he expects the 1987 EXPO to surpass the size and scope of all previous expositions. Exhibits at Food & Dairy EXPO '85 filled more than 262,000 net square feet and attracted high-ranking visitors from 70 nations.

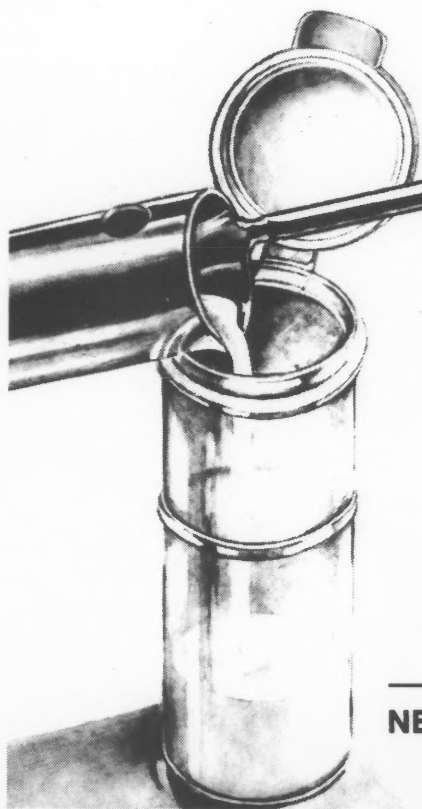

THE SWITCH IS ON! to HINGED CAP VIALS

- No opening tool is needed.
 - Aseptic sampling is easier. (And more likely)
 - Vials are FDA approved as a single service container.
 - Sterility is guaranteed w/o ethylene oxide.
 - Labeled lids stay with proper sample; no mix-up.
 - Double-lip locking rim is leakproof.
 - Vials are competitively priced.
- Ask for the trial case price on 1st order**

Available as an option: Automatic Vial Opener & Closer

- It works with infra-red feed racks.
- Hours of labor are saved.
- It holds lids vertically for laser scanning.

NELSON-JAMESON 1-800-472-8339 WISCONSIN
1-800-826-8302 OTHER STATES

The products included herein are not necessarily endorsed by Dairy and Food Sanitation.

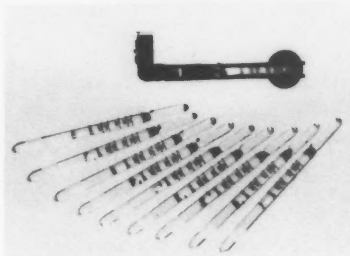

SKC Color Detector Tubes

New Tubes Measure Exposure to Toxic Gases

• New tubes are worn by worker and are designed to measure personal exposure to chemical hazards over a complete workshift or shorter periods. Tubes are currently available for 9 toxic chemicals, including such important ones as ammonia, hydrocyanic acid, carbon monoxide, hydrogen sulfide, nitrogen dioxide and sulfur dioxide. Sample is taken by diffusion and no pumps are required. Tubes are economical and convenient to use. Color change occurs in the presence of the chemical hazard and the length of the color indicates exposure dose.

For additional information contact: SKC, Inc., 334 Valley View Road, Eighty Four, PA 15330. 412-941-9701.

Please circle No. 275
on your Reader Service Page

Fossomatic 360 from Foss Food

• Foss Food Technology Corporation announces the introduction of a new ultra high speed somatic cell counter for use in the dairy industry. The FOSSOMATIC 360 is a fully microprocessor controlled instrument with a high level of on-board intelligence. This enables it to operate as a stand alone cell counter or to combine with the Milko-Scan 605 unit to form an integrated somatic cell and compositional analysis module. Throughput is 360 samples per hour. The operation is simple and sample preparation is restricted to simply warming the samples to 40 C. No fixing agent or additional sample preparation is required.

The unit is fully computer compatible with RS232 facility. The FOSSOMATIC 360 is an advanced development from the well established AOAC approved Fossomatic 215, which dominates somatic cell counting in milk laboratories throughout the world.

Please circle No. 276
on your Reader Service Page



Enercon Cap Sealers

Low Frequency Induction Technology for Cap Sealing

• For packagers who use inductively sealed pull tab liners, recent studies have demonstrated that low frequency solid state induction cap sealing units provide more uniform heat patterns for greater seal integrity when compared to high frequency vacuum tube devices.

With the recent introduction of induction foil seals with an easy-to-use pull tab feature, operating frequency of induction cap sealing equipment becomes essential. Due to the geometry of a liner with a pull tab, high frequency sealing currents are attracted to the edge of the liner, resulting in a weakened seal.

Studies by Enercon Industries Corp. (Menomonee Falls, WI) confirm that low frequency induction units have a more uniform wax melt, allowing the foil liner to separate from the pulpboard for easy removal of the pull tabs from a bottle-top.

This phenomenon occurs when using a solid state generator and sealing coil because ferrites direct the induction field into the appropriate areas of the liner. The lower frequency units, which operate between 26 and 50 kHz, are said to provide a stronger seal, without the risk of the tab liner sticking to the top of the closure or the pulpboard.

For more information on low frequency induction technology for cap sealing and corona treating equipment, contact: Enercon Industries Corp., P.O. Box 773, Menomonee Falls, WI 53051. 414-255-6070.

Please circle No. 277
on your Reader Service Page

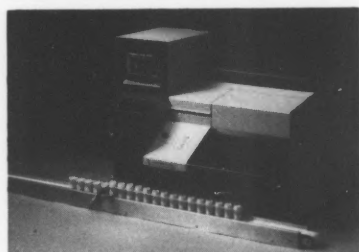

Fossomatic 360



Kjeltec Auto Plus

Tecator Develops 4th Generation of Kjeltec

• Tecator has now developed its fourth generation of Kjeltec. The new instrument, known as the Kjeltec Auto Plus, is designed to make fast, automatic, and accurate Kjeldahl protein/nitrogen analyses of Kjeldahl digests. With the Kjeltec Auto Plus, your sample is weighed, distilled, recorded, and evaluated automatically. The total analysis time is about 2 minutes. The result in % protein, % nitrogen, or ml titrant is presented in lab notebook format. Tecator's Kjeltec Auto Plus - now the most rapid, complete and proven Kjeldahl apparatus available. Let us explain our big Plus to you.

For more information contact: Tecator, Inc., P.O. Box 405, Herndon, VA 22070. 703-435-3300.

Please circle No. 278
on your Reader Service Page



LT Quantum 1200 from L. T. Industries
LT Quantum 1200
NIR Spectrophotometer

• The LT Quantum 1200 is a new NIR food quality and process control spectrophotometer. The analyzer measures rapidly, continuously and non-destructively constituents such as protein, moisture, fat, fiber, sugars and others in a variety of sample forms. The Quantum 1200 can be used both off line for quality assurance laboratories and on line for production control. The system is driven by our exclusive SpectraMetrix software package. Additional features include remote fiber optics measurement as well as extended spectral range for the visible.

For more information contact: L. T. Industries Inc., 6110 Executive Blvd., Rockville, MD 20852. 301-468-6777.

Please circle No. 279
on your Reader Service Page



Babson Bros. Arrest Teat Dip

Chlorhexidine Teat Dip

• Babson Bros. Co., manufacturers of SURGE dairy farm equipment, introduces a new chlorhexidine teat dip named ARREST. ARREST is the latest addition to the complete line of SURGE dairy sanitation products.

ARREST is a chlorhexidine teat dip that is ready-to-use, and has been field tested and proven by university research to reduce new infections of mastitis. ARREST has a blue color which can be readily seen on the cows' teats. The chlorhexidine complex provides fast, broad spectrum bactericidal activity. Special skin conditioning agents in a controlled pH base help keep teats soft and pliable.

ARREST is available in 1, 5, and 15 gallon containers in the U.S.

For more information about ARREST or other SURGE dairy sanitation products, contact your SURGE dealer or write: Babson Bros. Co., 2100 South York Road, Oak Brook, IL 60521.

Please circle No. 280
on your Reader Service Page

New Enzymatic Analysis Kits Introduced

• Boehringer Mannheim Biochemicals is introducing four new enzymatic test kits to detect:

- Formic Acid
- Nitrate
- Succinic Acid
- Lactose/D-Glucose

These kits are sensitive, rapid, easy-to-use and accurate. Because they are enzymatic they are also highly specific, even in complex food mixtures.

Each of these kits comes complete with all reagents, protocols for sample preparation and an assay procedure.

More information on these kits is available by contacting Boehringer Mannheim Biochemicals' Enzymatic Test Kit Department toll free: 800-428-5433 (in Indiana, call collect 317-849-9350).

Please circle No. 281
on your Reader Service Page



Soiltest Model 413-000

Alligator Soil Sampler From SOILTEST

• The SOILTEST Model 413-000, Alligator Soil Sampler is a super value for the soils investigator. Made of easily cleaned stainless steel, the Alligator sampler is a unit built for easy use in tough field conditions.

A convenient side step allows the operator's weight to force the sampler into the ground surface. Special design prevents damage to the hinge or split sample tube if the sampler is twisted in the ground.

After withdrawal, the entire sampling tube can be opened lengthwise giving easy access to the full length of the core sample. Samplers are available with 1 inch diameter tubes and 8 or 12 inch lengths (Models 413-000 and 413-001).

For additional information, contact SOILTEST Environmental, P.O. Box 931, Evanston, Illinois 60204. Call toll free 1-800-323-1242 (In Illinois call 1-800-942-3374); Telex 6871537 SOILT UW; Cable SOILTEST-EVANSTON.

Please circle No. 282
on your Reader Service Page

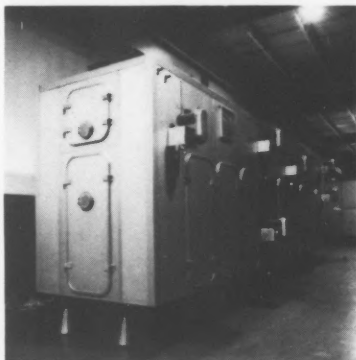

MLW Panels

Tech-Line Instruments Introduces Custom Designed Pilot Plants

• Custom made activated sludge pilot plants to suit particular applications such as studies of toxicity and process kinetics, investigating treatment methods and for training and research are designed and manufactured by Tech-Line Instruments. Purchasers of the pilot plants are municipalities, educational institutions, and consultants to industries. The plants can be equipped with special features such as controllable rates of air supply and return sludge, adjustable detention times and other features required for a particular application. Sizes range from bench scale to trailer or slab mounted. These plants are well engineered and manufactured by skilled craftsmen. Technical support is also available during start up and operation of the pilot plant.

For additional information contact: Tech-Line Instruments, Tri Campus Park, P.O. Box 1236, Fond du Lac, Wisconsin, 54935 or call toll free 1-800-328-7518. In Wisconsin call 1-800-242-3505.

Please circle No. 283
on your Reader Service Page

MLW Products Makes a Home for Macaroni

• Ralph Burgess had a problem.

His Food Engineering Corporation of Minneapolis, a manufacturer of food processing equipment, needed a custom insulated enclosure for its new line of continuous high-temperature macaroni dryers.

"And of course we wanted the best features," says Burgess, "Good insulation (to an "R" value of 20.5), flexural strength and puncture resistance, consistent thickness, corrosion resistance; we wanted all this at the lightest weight possible - at a reasonable price."

It also had to look good.

Burgess turned to MLW Products, Inc. with his laundry list.

MLW Products, Inc. responded to the criteria by custom laminating a composite of stainless steel inner skin and anodized aluminum outer face structurally bonded to one-eighth inch thick fiberglass substrate, with 2 1/2" thick, high temperature polyurethane core.

From a three-inch thick, four-by-14 foot panel, MLW Products routed doors, while retaining a panel thickness tolerance of .030 inches.

For more information contact: Mr. Charlie Correnti, National Sales Manager, MLW Products, Inc., 6755 West 65th Street, Chicago, Illinois 60638; 312-458-5900.

Please circle No. 284
on your Reader Service Page

Food Science Facts

For The Sanitarian



Dr. Robert B. Gravani
Cornell University
Ithaca, NY

COCKROACHES

Although there are about 55 species of cockroaches found in the US, 4 species commonly cause problems for the food industry. These insects are the:

- American Cockroach
- German Cockroach
- Brown-Banded Cockroach
- Oriental Cockroach

The description and habitat of each type will be discussed below.

American Cockroach

Description of Adult

Adults are reddish-brown to dark brown and are 1 1/2 - 2" long. They are among the largest cockroaches found. The wings are fully developed in both sexes and can be used for flying great distances. They can live for 2 - 2 1/2 years. They are considered good swimmers and can swim for a short period of time.

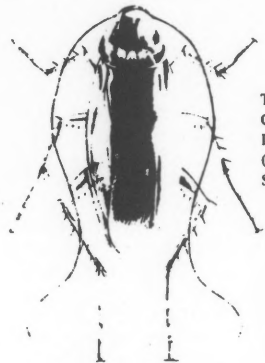

This Adult American Cockroach Is Shown In Natural Size (1 1/2 - 2" Long) Some Are Larger

Egg Case

The egg case is 3/8" long and is reddish brown or black. The female cockroach deposits the egg case that contains about 16 eggs. They hatch 45 days later and

the nymph period lasts 160 days. During the adult life-span, a female will deposit about 50 egg cases.

Habitat

American cockroaches prefer basements and furnace rooms; they develop in damp basements and sewers and can be found around pipes and plumbing fixtures.

German Cockroach

Description of Adult

This is the most active and most common of all the cockroaches. They are usually light brown, but can be very dark. Adults are 1/2" to 5/8" long and are more slender than other cockroaches. They have two dark streaks or stripes running lengthwise down the back. Their wings are well developed, and folded over giving them a pointed appearance at the rear end. They rarely fly. These cockroaches do not move far from their resting place. These cockroaches are shown below.

Male

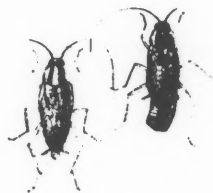

Female With Egg Case

(Slightly Larger Than Natural Size)

Egg Case

The egg case is yellowish or red-brown in color and the female always carries the capsule for about a month until it is ready for hatching. It usually contains about 30 to 48 eggs - more than the other cockroaches. The young mature in about 36 days. Adults usually live more than 200 days and 3 or more generations can occur in one year.

Habitat

They are often found in kitchens and cooking areas because they like heat and moisture. They live around sinks, water pipes, cupboards, in stoves, under refrigerators, water fountains and other appliances.

Brown-Banded Cockroach

Description of Adult

The brown-banded cockroach resembles the German cockroach but is slightly smaller and lacks the two dark stripes. The adults are 3/8 to 1/2" long and are dark brown to a pale golden color. These cockroaches have two brownish-yellow bands that traverse the back. The male has fully developed wings and is lighter in color than the female, whose wings are short and non-functional.

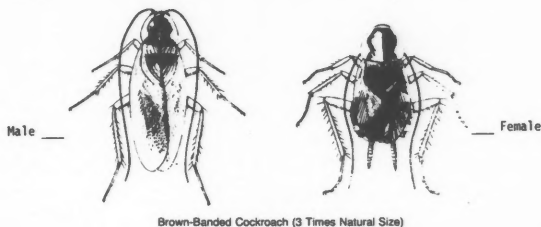

Brown-Banded Cockroach (3 Times Natural Size)

Egg Case

The egg case is yellowish or red-brown and the female deposits and attaches it in out-of-the-way places. Places of attachment include furniture, especially the undersides of shelves, the bottoms of drawers, tables and sinks. There are about 18 eggs in each case and after hatching they mature to adults in 54 days. The adult life span is about 200 days and there may be two generations annually.

Habitat

The brown-banded cockroach prefers high locations in heated rooms and is often found in cupboards, closets, storage rooms, desks, inside books, book bindings and telephones. They are generally found in clusters.

Oriental Cockroaches

Description of Adult

The Oriental cockroach is often referred to as one of the filthiest cockroaches. It is dark brown to shiny black and is 1 - 1 1/4" long. The male has fully developed, short wings while the female has underdeveloped wings. The lifecycle of the Oriental roach is similar to the American cockroach and they are also considered good swimmers.

Oriental Cockroach
(Approximately 2 Times Natural Size)

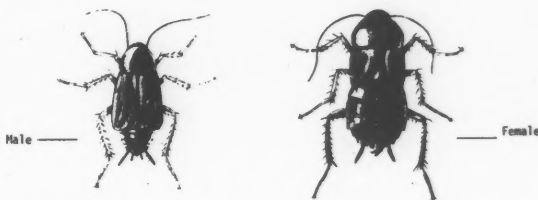

Egg Case

The egg case is dark-brown to nearly black in color and usually contains 16 eggs. The female does not carry the case, but deposits it. The young mature in about 128 days. The average adult lives about 1 year.

Habitat

The Oriental cockroach is found in cool, damp areas such as basements, sewers, and crawl spaces. They live in sewers and sometimes enter the building through sewer drains. They are also found around toilets and sinks where they are seeking sources of water.

The next issue of Food Science Facts will discuss the methods used to control cockroaches in food establishments.

INTRODUCING...

The Revolutionary New

Pull Tab Liner™

Perfect for Induction Sealing!
**It's like no other liner
you've ever seen!**

The unique pull tab liner allows the entire innerseal to be easily removed. There's no longer any need to pierce it with a finger nail or sharp object.

Designed for induction sealers, the combination of a pull tab liner sealed with a Lapel/PPS unit creates the ideal innerseal for your product. The beauty of the highly innovative pull tab innerseal is that it can be removed without sacrificing its tamper-evident features.

Find out what a revolutionary tamper-evident foil innerseal is really like. Call or write today.

FLASH: New B-200 Lining Machine Now Available.

Pull Tab Liners™

505 Boulevard • P. O. Box 198
Elmwood Park, NJ 07407
(201) 791-5850

HEPATITIS A — ALLEGANY COUNTY

How do you get to Wellsville, New York? Ask any one of 9,000 people in the Southern Tier of New York who got immune globulin (IG) shots in August and September. It all started in July 1985 when a young woman came from Texas to visit her family, who operated the South Main Sub Shop, in Wellsville, New York. She was not feeling well and had had a blood specimen taken when she visited a doctor before she left Texas. She helped out in the sub shop from July 15th on, even though ill. Her blood test was later reported positive for hepatitis A (IgM). The first 1,000 IG shots were the result of the mid-August onset of hepatitis A in four of her family members, some of them sub shop workers. Her sister also worked in Linza's Meat Market in Wellsville slicing cold cuts. Through newspaper and radio, people were notified that they should get IG shots if they ate at the sub shop or purchased cold cuts from the meat market in mid-August. Immune globulin may prevent hepatitis A only if given within 14 days of exposure to the virus. By the time the clinic was set up and news releases were out, the two week deadline was fast approaching.

The other 8,000 people to get IG shots were involved because the 14 day deadline had passed for another young woman from Alfred, New York who had eaten at the sub shop during August. When she went for the shot, she was told that it was too late. She developed Hepatitis A on September 4, 1985, and had worked for several days before and a day or so after onset. Her duties included slicing and packing cold cuts, and packing and icing baked products at the Shurfine Market, Alfred, New York. Her blood tested positive for hepatitis A (IgM test) on 9/10/85 when press releases went out, and over 8,000 people came for IG shots.

At least 15 cases of hepatitis A have been positively linked to the South Main Sub Shop in Wellsville. None have been linked to the Shurfine Market in Alfred so far. (Reported by Jeffrey Booth, New York State Department of Health and the Allegany County Health Department).

Editor's Note: This outbreak illustrates the "ripple effect" that occurs when food handlers are victims of foodborne diseases that are spread by food handlers. Identification of victims of foodborne disease outbreaks who are food handlers is particularly important with hepatitis A outbreaks in order to stop the ever expanding "ripple" or spread of the disease. Because the disease is easily spread through contaminated moist foods that are served without further cooking, personal hygiene of food handlers is of primary importance. Immunizing food handlers with IG within 14 days of their exposure to hepatitis A is the goal. However, as the Wellsville outbreak illustrates, this is not always possible. Hepatitis A virus is shed in feces in the highest numbers and the victim can be infective for up to a week or two before onset of symptoms (1). In fact, shedding of virus and infectivity drop off rapidly after onset of symptoms and most victims are probably noninfective a week after onset of jaundice (1). This infectivity before symptom onset has a profound effect on control measures. Exposed food handlers must be advised of the importance of personal hygiene, especially handwashing after using the bathroom. Proper handwashing can greatly reduce the opportunity for the spread of this disease through food handlers. Food handlers exposed to hepatitis A should be followed-up to check for symptoms. As with any disease that can be spread through food, as soon as

symptoms are noticed, the food handler must not handle food that will be eaten without further cooking.

The New York State Department of Health Memorandum Series 83-94 entitled "Actions that must be taken when a food handler is reported to have an infection capable of being spread through food" is available in limited numbers from the Food Protection Section, Bureau of Community Sanitation and Food Protection - (518) 474-3291. This publication offers valuable information about 16 diseases, including a detailed algorithm on handling of hepatitis A cases.

NYS MFS Newsletter 11/85

USDA'S MEAT AND POULTRY HOTLINE TO BE TOLL-FREE

If the best things in life are free, the U.S. Department of Agriculture's Meat and Poultry Hotline can be added to that list on July 1, when the service became toll-free.

"An estimated two million cases of food poisoning occur every year, and many can be prevented by proper food handling," according to Donald L. Houston, administrator of USDA's Food Safety and Inspection Service. "The hotline's home economists can help consumers with questions ranging from how long to keep meat and poultry in the refrigerator to how to pack a safe picnic lunch.

Changing the hotline to a nationwide toll-free number allows us to reach just about anyone who needs our help," said Houston.

Consumers dialing the new number — (800) 535-4555 — can get food safety tips for meat and poultry products and report problems experienced with such products. The toll-free hotline will operate from 10 A.M. to 4 P.M. EDT.

"The toll-free number makes the service more accessible," Houston said. "A test conducted in three states last fall showed we could anticipate 24,000 calls during the first year of the new service."

Callers in the Washington, D.C., metropolitan area can reach the hotline at (202) 447-3333. Hearing impaired individuals can reach the service by dialing either the "800" or the local Washington number. Both provide access to a telecommunications device for the deaf (TDD).

Since 1982, the hotline has operated without a toll-free number and has handled about 2,000 calls each year, Houston said.

For more information about the hotline, write to: Public Awareness, FSIS-USDA, Room 1163-S, Washington, D.C. 20250.

NYS MFS, Newsletter 11/85

SURVEILLANCE DATA — JUNE 1985

During the period January 1, 1985 through June 20, 1985, there were 295 investigations involving 1,689 cases of possible foodborne illness reported. Of the 295 investigations, 177 (60%) were not foodborne or insufficient information was available to include the investigation as a foodborne disease outbreak. During this period in 1984, 241 of 347 (68%) investigations fell into this category. While the number of reported investigations is down this year, the quality of the reports and

percentage of investigations that are confirmed or suspected foodborne disease outbreaks are higher.

SALMONELLA REPORTING INCREASES

There have been 15 outbreaks of salmonellosis reported in 1985 through August. Of those outbreaks where serogroups were reported, seven were serogroup B and 5 were serogroup D. Serogroup was not reported in three outbreaks. Salmonella serotype enteritidis was the most commonly reported serotype, accounting for all five of the serogroup D outbreaks. Eleven of these outbreaks occurred between May and August 1985.

In 1984, there were five outbreaks of salmonellosis reported through August and 11 for the entire year. Serogroup B was reported in six of the outbreaks, D in three and . . . in two. Serotype enteritidis was reported as the serotype in two of the serogroup D outbreaks. Serotyping was not reported for the third serogroup D outbreak. Three of these outbreaks occurred between May and August 1984.

The apparent increase in *Salmonella* serotype enteritidis in 1985 has not been shown to be linked to a common source so far. This increase makes it important to obtain detailed food histories on all reported cases of salmonellosis; and report any outbreaks to the Regional Office of Public Health as soon as possible.

NYS MFS Newsletter 11/85

SURVEILLANCE DATA — MAY 1985

During the time period January 1 - May 31, 1985, there were 279 investigations involving 1,306 cases of possible foodborne illness reported. There were 6 incidents where *SALMONELLA* was identified as the etiologic agent reported in May; this is more than were reported for the previous four months combined.

STAPHYLOCOCCAL FOODBORNE INTOXICATION-CHEMUNG COUNTY

The Chemung County Health Department reported a classic staphylococcal food poisoning during June 1985. They were able to submit samples of all foods served as well as several patient specimens to the New York State Health Department Bacteriology Laboratory.

The outbreak followed a 12:30 PM luncheon held by a local women's club. All the food was prepared by one person. Of the 15 attendees, 14 became ill with sudden onset of vomiting an average of three hours after the meal. Diarrhea developed in most of the ill persons about an hour after onset of vomiting. Two were hospitalized and a total of 10 reported to emergency rooms, so intense were the symptoms. All of the victims recovered over the next few days.

The luncheon consisted of sliced ham, deviled eggs, potato salad, and strawberry shortcake with whipped topping. *STAPHYLOCOCCUS AUREUS* was isolated from the ham (1.4×10^8 cfu/gm), the deviled eggs (2.5×10^7 cfu/gm), and the potato salad (8×10^7 cfu/gm). Even the mayonnaise and cream had small numbers of staphylococci. Stool specimens from two of the victims contained the same phage type of *S. AUREUS*

as the foods (53 at RTD, 53/83A at CON). For the first time, the lab was able to identify *STAP. enterotoxin* (type A).

A food preparation review showed that the foods were prepared the previous day and refrigeration space was inadequate. Much of the food remained unrefrigerated for many hours. In addition, the food handler was recovering from a stroke which had paralyzed one side of her face, causing her to drool. Her saliva was the probable source of the staphylococci.

NYS MFS Newsletter 11/85

Home Canned Sweet Corn Recipe causes Botulism. . .

A 23-year-old male was admitted to a Kentucky hospital complaining of weakness in the arms and legs in addition to trouble swallowing and speaking.

The patient had onset of his symptoms approximately 12-24 hours prior to admission. Weakness in the legs developed concurrently with the dysphagia and dysphonia. Weakness progressed upward and by late in the afternoon on the day of admission, he could not walk and had trouble speaking. He had some nausea and diarrhea. He was admitted to the hospital and a CT scan of the brain was scheduled. While undergoing CT, he had a respiratory arrest and required incubation. 24 hours after admission, he was transferred to a West Virginia hospital. CT scan of the brain and LP did not determine the etiology of his respiratory arrest.

Diagnoses entertained at this time included Guillain-Barre Syndrome, botulism and myasthenia. Because Guillain-Barre syndrome could not be ruled out, plasmapheresis was carried out. Electromyograms showed virtually no motor neuron activity with preservation of sensory neuron conduction. At this time, a more complete history became available. The patient had, apparently, eaten some "pickled corn" made by his mother. The recipe she followed did not call for adding large amounts of salt and vinegar to the pickling broth and canning was done in a hot water bath as described below.

CANNING PROCEDURES ASSOCIATED WITH THE CASE OF BOTULISM (AUG. 1984)

1. Cut sweet corn off the cob and add 5 cups of water.
2. Cook in an open kettle for 30 minutes.
3. Return the corn and water to 15 x 1 quart jars.
4. Add 1 TBS vinegar and 1 TBS salt to each quart jar, cover with lids and process for 10 minutes in a hot water bath.
5. Remove from the bath and store in a cabinet.

Samples of the corn that the patient had supposedly eaten, samples of pickled corn representative of other quart jars in the same canning "batch" in addition to samples of stool from the patient were sent to the CDC for screening for botulism toxin. Three of thirteen pickled corn jars tested were positive for the presence of botulinum toxin, type A. The patient's stool was positive for botulinum toxin of the same serotype. Interestingly, the jar from which the patient was thought to have eaten was negative and a jar from which the patient's mother had eaten was positive.

Over the next two months the patient had some return of motor function; however, he expired on 25 December 1984 of pulmonary complications partially caused by his respiratory paralysis.

Comments: The incidence of foodborne botulism has continued to increase. This case represents a typical case associated with home canning. Only vegetables high in acid, such as some

of the varieties of tomatoes, may be canned by the "hot water bath" method. Alternately, canning in a pressure cooker or pickling the vegetables with relatively high concentrations of vinegar and salt will prevent bacterial growth. In this case, the addition of merely 2 tablespoons of salt and vinegar for each quart of water was clearly insufficient to prevent bacterial growth.

The course of botulism varies from patient to patient depending on how much toxin the patient has ingested. In the case of the patient presented here, the onset of paralysis within 12 - 24 hours inferred that he had ingested a large amount of toxin. The role of treatment with anti-botulinum antitoxin is not clearcut. If treatment is to be effective, it should be administered as soon as possible after onset of symptoms, preferably before they occur. If a patient is completely paralyzed, it is unlikely that treatment will have any beneficial effect. Moreover, administration of this equine anti-toxin is associated with a 10% incidence of adverse reactions. With proper life support, including respiratory support and hyperalimentation, the prognosis is guarded, although recovery of respiratory function may take as long as 2 months and complete recovery a year or longer.

Taken from *Infectious Disease Newsletter* March 18, 1985, Volume 35, No. 5.

NYS MFS Newsletter 11/85

Please circle No. 141 on your Reader Service Page

Foodborne Illness Prevention Certification Training & Materials

for

Foodservice Corporations or State & City Health Departments

- One system for Employees - Managers - Trainers - Inspectors
- HACCP-based instruction
- Safe recipe procedure focus
- Food freshness and quality related to sanitation
- CDC and Bryan's data applied for hazard analysis
- FDA and ETS certification requirements exceeded
- Regulatory agencies can use for unit self-regulation and reduced inspection costs
- Easily customized to your unique requirements

Hospitality Institute of Technology & Management



830 Transfer Road
St. Paul, Minnesota 55114
612-646-7077

Simpler standardization. Substantial savings. Service. Satisfaction.

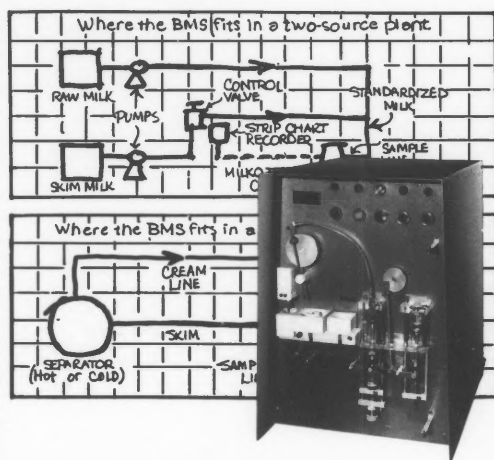

A Foss Food Technology Butterfat Monitoring System will save your butterfat, and increase your profits. Automatically. Continuously.

The BMS installs easily in your standardized milk line. As often as every 20 seconds you get an automatic butterfat analysis. No waiting for lab tests. No need to standardize tanks individually. With the BMS you've got the kind of instant control that can pay for the system in less than six months.

You can even change products in just a minute or two.

The system is simple. the savings are substantial. Call or write today for complete details.



Foss Food Technology Corporation

"Setting A New Standard"

• Foss Food Technology Corporation • 10355 W. 70th Street • Eden Prairie • MN 55344, USA •
• Telephone (612) 941-8870 • Telex 291160 FOSSFOD US • FAX: 612-941-6533 •



Joint Seminar Held April 21

Joe Byrnes, Kraft Foods and 1st vice president of the Associated Illinois Milk, Food, and Environmental Sanitarians (AIMFES), hands audience questions to Elliot Ryser, Department of Food Science, University of Wisconsin during the spring seminar conducted jointly by AIMFES and the Chicago Dairy Technology Society.

Other speakers (r to l): Charles Price, FDA Region 5, Lewis Schultz, Illinois Department of Public Health, and Bruno Jadowic, Quality Check Dairy Products Association - with Tom Chojnacki, Dupage County Health Department at far left. Not pictured: Michael McClory, McClory Consulting Services.

The seminar, held April 21, attracted more than 140 sanitarians for a full afternoon session which closed with a banquet and an address by Dale Seiberling, Seiberling Associates, Incorporated.

TAMFES Meeting Highlights

Two hundred and eighty-eight individuals registered for the Fourth Annual Texas Association of Milk, Food and Environmental Sanitarians meeting held June 3rd and 4th at the South Plaza Hotel, Austin, Texas. David Cochran, P. E., Associate Commissioner for Environmental and Consumer Health Protection, kicked off the meeting with welcoming remarks. Ed Auler Investments, gave a talk on the history and expected growth of the wine industry in Texas. A talk on medical fraud followed Mr. Auler's talk.

Featured speaker's for the food session included talks on fumigation, drugs in animals, regulatory disparities, ground water in Texas and irrigation of foods. Speakers for the milk session covered such topics as quality aspects of cultured dairy products, shelf life prediction methods, Food and Drug surveillance, engineering a water treatment program, management practices and titratable acidity, and public health implications of the recent salmonellosis and listeriosis outbreaks associated with milk and dairy products.

As a result of a talk given by Jerry Kozak, Chief Milk Safety Branch, Food and Drug Administration, it was decided in the business meeting to set up a milk sanitarian training program that would be sponsored by the Texas Association of Milk, Food and Environmental Sanitarians and assisted jointly by the Texas Department of Health and the Food and Drug Administration.

Joe Goddard, Texas Tech University, served as president for 1985-86 and conducted the annual business meeting. James Roberson, H.E.B. Grocers, in San Antonio, will serve as President of TAMFES for 1986-87. Wendell Littlefield, Texas Department of Health, Milk and Dairy Division, was elected as president-elect and Janie Park as Secretary.

A Bar-B-Que and Country-Western dance at the Manchaca Volunteer Fire Department highlighted the entertainment program.

Plaques and certificates of merit were given to Mr. Kirmon Smith and Dr. Ron Richter for outstanding service to the Texas Association of Milk, Food and Environmental Sanitarians.

Award Presented at FAMFES Annual Conference April 22, 1986

The Florida Association of Milk, Food and Environmental Sanitarians (FAMFES) Scholarship of \$500 was awarded to *Ms. Tammy J. Thomas*, a senior in food science. This award was presented at the FAMFES annual educational conference, April 22, 1986 at the University Inn, Orlando, FL. *Mr. Marc A. Vargas*, a senior in food science, is also recognized by the Food Science & Human Nutrition Department as the recipient of the HOWARD APPLIEDORF MEMORIAL SCHOLARSHIP of \$250.

PAY YOUR DUES EARLY...

Beginning in September you will receive your first renewal notice for 1987. Please be sure and renew BEFORE December 31, 1986. Although you receive your back issues if you renew late, it is possible that we will not be able to fulfill all back issues if you renew too late.

Quality and choice.

Leading European Technology in Stainless Steel Sanitary Flow Control Products

Please circle No. 139 on your Reader Service Page

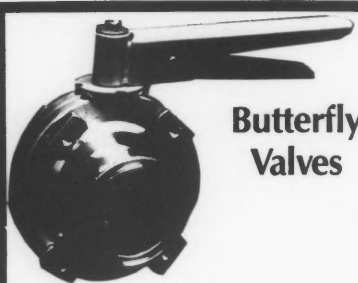

Butterfly Valves

- Available with air-to-air or air-to-spring actuators.
- 304 or 316 stainless steel.
- Meets 3A Standards.
- Sizes from 1-4 inches.

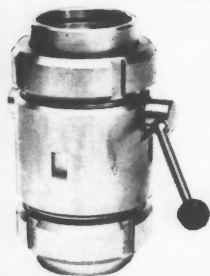

Check Valves

- Bi-directional flow option reduces C.I.P. piping cost.
- 304 or 316 stainless steel.
- Normal check valves available in 1-4 inches.



Piston Valves

- Available with 2, 3, 4, and 5 ports.
- Easily changed from spring-to-close to air-to-close.
- Sizes 1-4 inches.
- Double-seated valves designed for C.I.P. and brewery applications also available.

KOLTEK Valves

The KOLTEK Valve is a patented design unlike any other in the industry, and is available in 2, 3, and 4 port configurations, in all sizes. Simple field conversions from manual to pneumatic can easily be made. A 3-way valve can be 2, 3, or 4 position simply by changing actuators. It sets new standards in performance, economy, and operating versatility, and has been proven in thousands of applications by major companies throughout the world. KOLTEK Valves meet 3A Standards and are designed for easy cleaning-in-place.

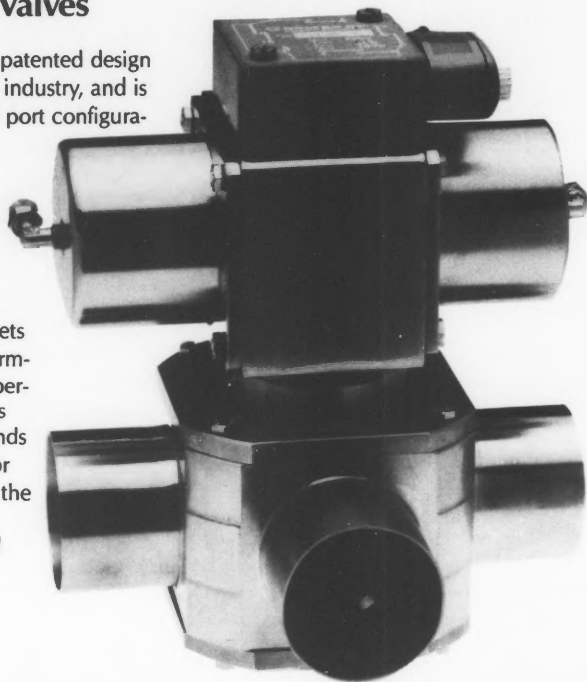

Pumps



Hackman offers a complete line of centrifugal and self-priming pumps. Extremely high lifting heights are possible with liquid ring self-priming pumps. The self-priming pumps are used in applications where air mixes with the liquid, and as a C.I.P. return pump. All parts exposed to liquid are 316 stainless steel. Available in 7.5, 10, and 20 horsepower.

Meters

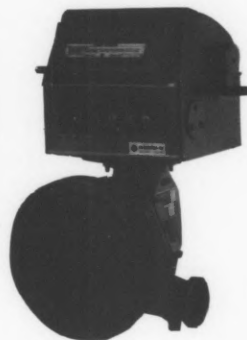

Hackman manufactures a complete line of rotary piston meters, air eliminators, and other flow control units.



HACKMAN FLOW

P.O. Box 28, Brunswick, Georgia 31520

Phone: (912) 264-0950

Telex: 293593

New Members

Alabama

Rob Jamrog
Dairymen, Inc.
Decatur

Paul McDowell
Dairymen, Inc.
Decatur

California

Keith J. Benson
APO San Francisco

Clifford M. Coles
Del Mote Corp.
Walnut Creek

David W. Fishel
Tulare Co. Dept. Health Serv.
Visalia

Rob Robbins
Dairy and Food Labs, Inc.
San Francisco

Sheryl Werdein
Victorville

Colorado

Ted Nuncio, Pres.
CLN Industries, Inc.
Denver

Florida

Erich P. Lerchenfeld
H.P. Hood Inc
Dunedin

Georgia

Michael R. Smith
DeKalb Co. Environmental
Health
Clarkston

Illinois

Rona B. Klausner
Swift-Eckrich, Inc.
Wheaton

Robert M. Livingston
Village of Arlington Heights
Arlington Heights

Iowa

Sue M. McCloy
Swiss Valley Farms Co.
Jackson

Michigan

Emily Linebaugh
Keebler Company
Grand Rapids

Sally Smith
St. Clair

New Jersey

Adele M. Bednar
T.J. Lipton
Englewood Cliffs

Leonard Bornemann
Johanna Farms Inc.
Flemington

New York

H. Carl Smith
Diversified Vial Corp.
Fonda

William G. Vomvoris
Presbyterian Hospital
New York

North Carolina

Thomas C. Williamson
N. C. Div. of Health Serv.
Raleigh

North Dakota

Janine Sue Hansen
North Dakota Dairy Dept.
Bismarck

Ohio

Douglas D. Henry
Warren Rupp-Houdaille, Inc.
Mansfield

John R. Stinger, Jr.
Drew Chemical Corp.
Columbus

Tennessee

Patrick J. Cardiff
Kraft, Inc.
Greeneville

John Ramer
Dean Foods Co.
Memphis

Bobby D. Shipley
Lewisburg

Texas

Ernest D. Adams
Fort Worth Public Health Dpt.
Fort Worth

Homer C. Emery
US Army
San Antonio, TX

Virginia

Ralph J. Bagley
Blackstone
Tom Ericson
Marva Maid Dairy
Newport News
Linwood A. Lewis, Jr.
Blackstone
Keith Long
Ashburn
Ed Shannon
Midlothian
Stanley Walker
Ivor

Washington

Dr. Faye M. Dong
University of Washington
Seattle
Gena L. Reich
Kennewick
Lucy Severs
Olympia Cheese Co.
Olympia

Canada

Richard Bassett
Ideal Food Service Equip.
Toronto, Ontario
Marielle Dube
Lachine, Quebec

Australia

Dr. Juliana Kaya Prpic
Melbourne, Victoria

Iraq

F. M. Abbar
Mosul University
Mosul

Ireland

Noel Finn
Cork

CHEMLAND has the products for you

In case you didn't know. . .
Chemland manufactures over 200 products which have appropriate
E.P.A., U.S.D.A., or local state approvals!

TEAT DIPS

T.D. TEAT DIP — Iodine complex containing 10,000 ppm iodine with 10% glycerine as the skin conditioning agent. Broad spectrum germicide fast in "kill rate" and persistent under organic challenge.
PRO-TEAT 1 — Iodine complex containing 10,000 ppm iodine and low glycerine for use in all but extreme weather and wind conditions.
PRO-TEAT 2 — Iodine complex with 5,000 ppm iodine and low glycerine.
T.D. 2 — Iodine complex with 5,000 ppm 5% glycerine. A lower strength concentration of germicidal teat dips for year around use when conditions permit, and proven for years on many large herd farms.
DIP & SPRAY — Iodine complex with 3,500 ppm iodine and glycerine and lanolin skin emollients combination. Works well through automatic teat dip sprayers as a pre-dip or post-milking dip.
Q-DIP — Quaternary teat dip and conditioner. A broad spectrum germicide alternative to iodine dips.
HEXA DIP — Chlorhexidine/quaternary ammonium product with superior skin conditioning properties. Another alternative to iodine when conditions require a different product.

SANITIZERS — DISINFECTANTS FOR EQUIPMENT & UDDERS

BIO-HATCH — Quaternary sanitizer. E.P.A. approved for equipment and bovine udders. Excellent fungicide which reduces foot rot when used regularly in wash pen water treatment systems. Excellent surfactant property aids in removal of udder soil loads and promotes faster drying prior to milking.
1-DYNE DISINFECTANT AND UDDER WASH — 1.75% titratable iodine can be used on both equipment and udder tissue to economically sanitize in a short contact time.
UDDER DYNE — Low acid iodine udder wash with non-irritating quality.
MYCO-BAC — Highly concentrated iodine sanitizer and udder wash. The product of choice for backflush equipment systems, drop-hope iodine systems and tank sanitizing. Effective, economical.
EXTRACT & EXTRACT-2 — Chlorine sanitizer for equipment surfaces. May be added to wash soap solutions to boost cleaning power for removal of protein build-up.

PIPELINE AND C.I.P. CLEANERS

DAIRY CYCLE 3 — Our premium chlorinated liquid C.I.P. cleaner suitable for pipeline or bulk tank cleaning. A powerful liquid alkaline cleaner with superior water softening and rinsing properties.
DAIRY ONYX — Chlorinated C.I.P. liquid; economical dilution use in water up to 12 grains hardness.
DAIRY PLACID — Liquid C.I.P. and pipeline acid cleaner that is ideal for daily cleaning. Safe on stainless, yet prevents scale build-up with used regularly.
DAIRY CHOICE 1 — Heavy duty chlorinated powder pipeline cleaner with superior watering softening qualities.
SANCHLOR — This C.I.P. chlorinated powdered cleaner has proven itself under variable conditions of water hardness, temperature and turbulence. An economical, trouble-free pipeline cleaning choice.

INSECTICIDES

SURSECT N-3 — A 0.3% dual synergist natural pyrethrin cattle spray insecticide. Fog or spray.
SURSECT-500 — A 0.5% dual synergist natural pyrethrin insecticide. Ready to use.
SURSECT XV — A 0.15% synergized natural pyrethrin insecticide for spray or fog.

EQUIPMENT

Automated pump metering systems for pre-milking udder sanitation are a Chemland specialty. Pre-fabricated drop-hose iodine pumps and wash pen water treatment systems are available upon request.

AND MANY, MANY MORE. ASK US ABOUT OUR FULL CHEMLAND LINE.

SERVING OVER 800 DAIRIES IN CALIFORNIA ALONE!

"When it comes to Sanitation. . . come to Chemland"



For information call Paul Hyde:
TN (800) 238-7261
CA (800) 222-3411

IAMFES Affiliate Officers

ALBERTA ASSOCIATION OF MILK, FOOD AND ENVIRONMENTAL SANITARIANS

Pres., Dr. M. E. Stiles Edmonton
 Past Pres., Dr. Harry Jackson Edmonton
 Pres. Elect, Lorne Clarke Edmonton
 Sec'y., Cherise Foster Edmonton
 Treas., Jim Eisen Edmonton
Directors:
 Sam Sohail Edmonton
 Dr. Gordon Greer Lacombe
 Rick Leyland Red Deer

Mall all correspondence to:

Jim Eisen
 Field Representative
 Lucerne Foods, Ltd.
 11135 151 St.
 Edmonton, Alberta, Canada
 403-451-0817

CALIFORNIA ASSOCIATION OF DAIRY AND MILK SANITARIANS

Pres., Bill Bordessa, Bureau Milk & Dairy Foods Control, P.O. Box 2022, Merced, CA 95344
 1st Vice Pres., Austin D. Olinger Upland
 2nd Vice Pres., Willard L. Howder .. Martinez
 Recording Sec'y., Ralph Smith Tulare
 Past Pres., Joe M. Cardoza Santa Clara

Mall all correspondence to:

Richard C. Harrell
 CADMS Executive Sec.
 1554 West 120th St.
 Los Angeles, CA 90047
 213-757-9719

CONNECTICUT ASSOCIATION OF DAIRY & FOOD SANITARIANS, INC.

Pres., Nicholas Macelletti Hartford
 Vice Pres., Edward Ronan West Haven
 Sec'y., Paul Gotthelf Hartford
 Treas., William Peckham Killingworth

Board of Governors:

Dr. Benjamin Cosenza	Dr. Jesse Tucker
George Norman	Philip Vozzola
William Geenty	Lucy Bassett
Dr. Lester Hankin	Henry Fournier
David Herrington	J. Frank Martin
C. Rodney Banks	John Karolus
Paul Danilowicz	

Mall correspondence to:

Dr. Lester Hankin
 The Conn. Agric. Exper. Sta.
 PO Box 1106
 New Haven, CT 06504
 203-789-7219

FLORIDA ASSOCIATION OF MILK, FOOD AND ENVIRONMENTAL SANITARIANS, INC.

Pres., Dick Jolley Bradenton
 Pres. Elect, Oliver W. Kaufmann .. Bradenton
 Past Pres., Cliff Muncey Miami
 Sec'y. Treas., Dr. Franklin Barber

Board:

Dave Fry
 Dr. Jim Jezeski
 Sonya Gambel
 William Hensley
 Marian Ryan

Mall all correspondence to:

Dr. Franklin Barber
 4403 Sea Cove, Sea Woods

New Smyrna, FL 32069
 904-428-1628

IDAHO ENVIRONMENTAL HEALTH ASSOCIATION

Pres., Nancy Bowser, 1455 North Orchard, Boise, ID 83706
 Pres. Elect, Brian Dixon St. Anthony
 Sec'y. Treas., Jaren Tolman
Mall all correspondence to:
 Jaren Tolman
 Rt. 3, Box 293
 Burley, ID 83318
 208-678-7524

ILLINOIS MILK, FOOD AND ENVIRONMENTAL SANITARIANS

Pres., Ken Anderson, Harold Wainess & Assoc., 464 Central Ave., Northfield, IL 60093
 Pres. Elect, Robert Crombie Joliet
 1st Vice Pres., Joe Byrnes Glenview
 2nd Vice Pres., Phil Hermesen .. Schaumburg
 Sec'y. Treas., Clem Honer Glen Ellyn
Mall all correspondence to:
 Clem J. Honer
 1 S. 760 Kenilworth Ave.
 Glen Ellyn, IL 60137
 312-693-3200

INDIANA ENVIRONMENTAL HEALTH ASSOCIATION INC.

Pres., Ted Alexander Indianapolis
 Pres. Elect, David E. Holder Indianapolis
 Sec'y., Nancy Landau Indianapolis
 Treas., Barbara Meyer Susorney . Indianapolis

Mall all correspondence to:

Indiana Environmental Health Assoc.
 Attn: Tammy Fleenor
 Indiana State Board of Health
 1330 W. Michigan Street
 Indianapolis, IN 46206
 317-633-0173

IOWA ASSOCIATION OF MILK, FOOD AND ENVIRONMENTAL SANITARIANS, INC.

Pres., Derward Hansen Exira
 Pres. Elect, Ralph Sanders Waterloo
 1st Vice Pres., Monty Berger Decorah
 2nd Vice Pres., Wilbur Nielson . Independence
 Sec'y. Treas., Dale Cooper Manchester
Mall all correspondence to:
 Dale Cooper
 Box 69
 Manchester, IA 52057
 319-927-3212

KANSAS ASSOCIATION OF SANITARIANS

Pres., Alan Gremmel, Milk Control, 1900 East 9th St., Wichita, KS 67214
 1st Vice Pres., Loren Brock
 2nd Vice Pres., Mary May
 Sec'y. Treas., John M. Davis
Mall all correspondence to:
 John M. Davis
 Wichita - Sedgewick Co.
 Dept. of Comm. Health
 1900 E. 9th

Wichita, KS 67214
 316-268-8351

KENTUCKY ASSOCIATION OF MILK, FOOD & ENVIRONMENTAL SANITARIANS, INC.

Pres., Bland Doris
 Vice Pres., Dale Marcum
 Sec'y. Treas., Betty Kelly
Directors:
 Region I Max Weaver
 Region II William Montgomery
 Region III Ross Stratton
 Kenny Yeager
 Joseph Schureck
 Region IV D. S. Hughes
 Region V David Atkinson
 William Murphy
 Brenda Ward
 Region VI Berford Turner
 Region VII Gary Coleman
Mall all correspondence to:
 Betty Kelly
 Rt. 7, Box 55A
 Shelbyville, KY 40065
 502-564-7647

MICHIGAN ENVIRONMENTAL HEALTH ASSOCIATION

Pres., Terry Anderson Lansing
 Pres. Elect, Guy Estep Grand Rapids
 Past Pres., Stephen R. Tackitt . Mt. Clemens
 Sec'y., Joseph Hibberd Lansing
 Treas., Debra L. VandeBunte Holland
Directors:
 Glenn Beers
 William DeHaan
 David Gregg
 Douglas Park
 Peggy French
 Roger Stroh

Mall all correspondence to:

Joseph Hibberd
 Michigan Dept. of Public Health
 P.O. Box 30035
 Lansing, MI 48909

MINNESOTA SANITARIANS ASSOCIATION INC.

Pres., William Coleman, MN Dept. of Agric., 90 W. Plato Blvd., St. Paul, MN 55107
 Pres. Elect, Larry Hemmingsen .. Minneapolis
 Vice Pres., Steve Watrin Mora
 Sec'y. Treas., Roy Ginn
Mall all correspondence to:
 Roy Ginn
 Dairy Quality Inst.
 2353 N. Rice St., Suite 110
 St. Paul, MN 55113
 612-484-7269

MISSISSIPPI ASSOCIATION OF SANITARIANS, INC.

Pres., Andy Cotton, Oktibbeha County Health Dept., Lamkin St., PO Box 108, Starkville, MS 39759
 Pres. Elect, L. B. Barton Lucedale
 1st Vice Pres., John Campbell ... Vicksburg
 2nd Vice Pres., Charles Blakely ... Grenada
 Sec'y Treas., Maurice Herington Gulfport
Mall all correspondence to:

Maurice Herrington
2400 14 Street
Suite 203
Gulfport, MS 39501

MISSOURI MILK, FOOD AND ENVIRONMENTAL HEALTH ASSOCIATION

Pres., David Welde Springfield
Pres. Elect, Douglas Dodson St. Louis
Sec'y., Reid Stevens Jefferson City
Treas., John G. Norris Jefferson City

Mall all correspondence to:
John Norris
Division Health
Box 570
Jefferson City, MO 65101
314-751-3696

NEW YORK STATE ASSOCIATION OF MILK AND FOOD SANITARIANS

Pres., Gaylord B. Smith, 1385 Regent St., Schenectady, NY 12309
Pres. Elect, Robert J. Gales Hancock
Past Pres., Joseph Ferrara Albany
Cornell Coord., David Bandler Ithaca

Mall all correspondence to:
Paul Dersam
27 Sullivan Rd.
Alden, NY 14004
716-937-3432

NORTH DAKOTA ENVIRONMENTAL HEALTH ASSOCIATION

Pres., Robert Hennes, Chief Sanitarian, State Laboratories Dept., P.O. Box 937, Bismarck, ND 58505
1st Vice Pres., Donna Becker, 1st District Health Unit, Minot, ND 58701
Past Pres., Keith Johnson Stanton
Sec'y., Scott Holmes, State Health Dept., Div. of Environmental Sanitation, Bismarck, ND 58505-5520
Mall all correspondence to:
Scott Holmes
State Health Dept.
Div. of Environmental Sanitation
Bismarck, ND 58505-5520
701-224-4600

OHIO ASSOCIATION OF MILK, FOOD AND ENVIRONMENTAL SANITARIANS

Pres., Emil Mikolajcik, Food Sci. & Nutr., OSU, 2121 Fyffe Rd., Columbus, OH 43210
Vice Pres., Harold Stone Cleveland Heights
2nd Vice Pres., Hermine Willey Reynoldsburg
Past Pres., Dean Devore Newark
Intl. Advisor, Harry Haverland Cincinnati
Mall all correspondence to:
Donald L. Barrett
6727 Deepwood Ct.
Reynoldsburg, OH 43068
614-222-6195

ONTARIO FOOD PROTECTION ASSOCIATION

Pres., J. D. Cunningham, Dept. of Environmental Biology, University of Guelph, Guelph, Ontario, N1G-2W1

Vice-Pres., I. R. Patel Teeswater
Sec'y. Treas., J. Willekes Scarborough
Past Pres., G. Huber Toronto
Directors
M. Brodsky Toronto
J. Roth Niagara Falls
F. Eckel Waterloo
P. Kwan Toronto
R. Brown Harrison
J. Schramek Cambridge
Mall all correspondence to:
Ontario Food Protection Assn.
P.O. Box 79
Streetsville, Ontario
Canada L5M 2B7

OREGON ASSOCIATION OF MILK, FOOD AND ENVIRONMENTAL SANITARIANS, INC.

Pres., Al T. Rydmarck, 1165 North Locust, Canby, OR 97013
Vice Pres., Robert Williams Salem
Sec'y Treas., Floyd W. Bodyfelt Corvallis
Directors:
Ron McKay Salem
Robert Gerding Philomath
Mall all correspondence to:
Floyd Bodyfelt
Wiegand Hall 240
Oregon State University
Corvallis, OR 97331
503-754-3463

PENNSYLVANIA DAIRY SANITARIANS ASSOCIATION

Pres., James R. Barnett Strasburg
Pres. Elect, Arthur C. Freehling
Vice Pres., Donald Lerch
Sec'y. Treas., Audrey Hostetter Throne
Assoc. Advisors:
Stephen Spencer
Sidney Barnard
George W. Fouse
Mall all correspondence to:
Audrey Hostetter Throne
Hershey Choc. Co.
19 E. Chocolate Ave.
Hershey, PA 17033
717-534-4031

SOUTH DAKOTA ENVIRONMENTAL HEALTH ASSOCIATION

Pres., Morris Forsting Sioux Falls
Pres. Elect, Richard McEntaffer Pierre
Sec'y. Treas., Stanley A. Iwagoshi Sioux Falls
For more information contact:
Stanley A. Iwagoshi
South Dakota Dept. of Health
1320 S. Minnesota, Suite A
Sioux Falls, SD 57105
605-339-7113

TENNESSEE ASSOCIATION OF MILK, WATER AND FOOD PROTECTION

Pres., Ray Rottero
Past Pres., Carl Moore
Pres. Elect, David Mayfield
Vice Pres., Dr. B. J. Demott
Sec'y-Treas., Cecil White
Archivist, Ruth Fuqua
Mall all correspondence to:
Cecil White
1418 Highland
Murfreesboro, TN 37130
615-893-0286

TEXAS ASSOCIATION OF MILK, FOOD AND ENVIRONMENTAL PROTECTION

Pres., James Roberson San Antonio
Pres. Elect, Wendell Littlefield
Sec'y., Janie Park
Past Pres., Joe Goddard
Mall all correspondence to:
Prof. Ron Richter
Kieburg Center
Texas A&M University
College Station, TX 77843
409-845-4409

VIRGINIA ASSOCIATION OF SANITARIANS AND DAIRY FIELDMEN

Pres., T. Greg Snow
1st Vice Pres., Donna Izac
2nd Vice Pres., Charles Mattox
Sec'y, Treas., W. J. Farley Staunton
Mall all correspondence to:
W. J. Farley
Route 1, Box 247
Staunton, VA 24401
703-434-3897

WASHINGTON MILK SANITARIANS ASSOCIATION

Pres., Donald Penders, WSDA, N. 222 Havana, Spokane, WA 99201
Pres. Elect, Paul Nelson Seattle
Sec'y. Treas., Lloyd Luedecke Pullman
Mall all correspondence to:
Lloyd Luedecke
NW 312 True St.
Pullman, WA 99163
509-335-4016

WISCONSIN ASSOCIATION OF MILK AND FOOD SANITARIANS

Pres., Eugene Lindauer, WI Dpt. of Ag, Trade & Cons. Prot., 220 N. Jefferson St., Suite 146 A, Green Bay, WI 54301
Vice Pres., Dale Hachmann
1st Vice Pres., Randy Daggs Madison
Sec'y. Treas., Neil Vassau Madison
Past Pres., David Meyers Arcadia
Mall all correspondence to:
Neil M. Vassau
PO Box 7883
Madison, WI 53707
608-267-3504

WYOMING PUBLIC HEALTH SANITARIANS ASSOCIATION

Pres., Gary Hickman, Cheyenne/Laramie Co. Health Dept., 1710 Snyder Ave., Cheyenne, WY 82001
Pres. Elect, Tyrone Welty Capper
Sec'y., Sandra Knop Green River
Treas., Sandra Palmer Cheyenne
Mall all correspondence to:
Sandra Knop
Wyoming Dept. of Health
PO Box 1153
Green River, WY 82835
307-875-5846



N.M.C.

NATIONAL MASTITIS COUNCIL

Are Your Machines Causing Mastitis?

For many years, the milking machine has been implicated as being a causative factor in the mastitis complex. In spite of numerous studies, the magnitude and the mode of an increase in the new infection rate by the milking machine still is not clear.

It seems obvious that the machine can act as a transfer agent of infectious organisms from cow to cow during milking. Studies of various machine parameters such as vacuum level, pulsation rate, ratio and phase (2x2 versus 4x0) have failed to provide convincing evidence of a definitive and direct cause of an increase in the new infection rate. On the other hand, gross malfunctions such as clogged air bleeds and inoperative vacuum controls have been associated with high rates of mastitis.

In general, the milking machine appears to have a fairly low association with mastitis incidence. Danish workers place the number of mastitis infections associated with the machine at 3 to 6 percent. In most cases, it is difficult to produce the disease experimentally with the machine in controlled studies. The swinging vacuum machine, air blasts that simulate liner slip, and pulsation failure are exceptions.

Vacuum instability is said to be the culprit affecting mastitis. A definition of vacuum instability has yet to be established and measuring positions and methods are variable and vague. In addition, much of the field equipment in use to measure vacuum stability lacks precision and sensitivity.

In the United States, field observers have suggested that the objective is to establish a steady teat end vacuum. These objectives appear unjustified since vacuum fluctuations are inherent in any two-phase (milk and air mixture) flow system. In addition, the pulsating liner causes a cyclic change in vacuum on a regular basis. It is clear that pulsation is necessary under currently known technology.

The only known effect of vacuum stability on the new infection rates is the impact mechanism. The impact force is the result of high velocity air/milk in retrograde flow toward the teat end through the short milk tube. High speed pressure fronts traveling toward the teat end apparently have the ability to carry infective organisms into the streak canal when the liner is in the open position. Massive vacuum fluctuations occur as the result of liner slip, careless machine attachment, and rough or improper machine removal. Impacts probably arise from such events occurring mainly within the individual milking unit rather than from interactions between units or between units and other machine components.

In summary, the milking machine probably is over-estimated in terms of its causative effect upon the new infection rate. It can, however, serve to carry pathogens from cow to cow and accelerate the new infection rate when malfunctioning. Vacuum instability, due to sudden large air admission into the clawpiece such as liner slip, careless machine stripping and removal are important factors in the new infection rate. Other forms of instability such as cyclic variation due to pulsation and variation due to milk flow have less importance than generally believed.

1840 Wilson Blvd.
Arlington, VA 22201
703-243-8268

THE CLEAN HOMOGENIZER

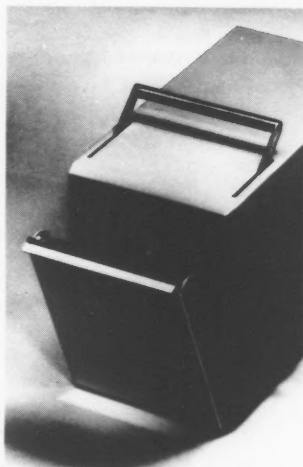

Minimize Contamination with the Colworth Stomacher® Lab Blender . . . Exclusively from Tekmar.

The Stomacher is a proven method for quick, contamination-free removal of intact microbes from food and other samples because blending is done in sterile plastic bags. There is never contact between your sample and the machine. Most samples are processed in 30-60 seconds, and there is no clean-up between samples. Applications:

- Dairy
- Frozen Foods
- Canned & Processed Foods
- Meat, Poultry & Fish
- Flour Products
- Fruits & Vegetables

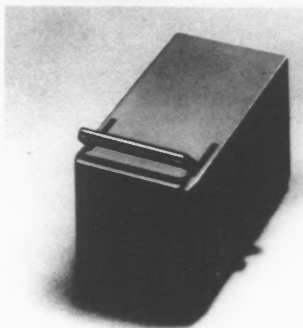

Tekmar

P.O. Box 371856
Cincinnati, OH 45222-1856
(513) 761-0633
(800) 543-4461

- Send me more on how I can clean up my Microbial Tests!
- Send information on new lab bags for the Stomacher.
- Have salesman call.

Name _____
 Institution _____
 Dept. _____
 Street _____
 City _____
 State _____
 Zip _____
 Phone _____

Tekmar

P.O. Box 371856
Cincinnati, OH 45222-1856
(513) 761-0633
(800) 543-4461

Please circle No. 216 on your Reader Service Page

Measurements in the Rheology of Foodstuffs, by J.H. Prentice, Elsevier Science Publishing Co., Inc., New York, NY, 1984.

This book is based on the simple but basic premise that readings of rheological instruments are as much a measure of the device as the material under test. The state-of-the-art of rheological measurements is such that our interpretation of the physics of what occurs by a material in an instrument is more limiting than our mathematical description of material behavior. The book describes rheological behavior from the fluid flow point of view, not from the solid view point. With the mathematical equations in mind, the terms are identified which need to be experimentally determined. This methodology is particularly useful if one wants to compare instruments' basic operating principle, build a better instrument, or choose between available instruments. The reader will not find a list or description of instruments that have been or are commercially available. The book also describes the accuracy and reliability that is required when making measurements with various instruments to obtain adequate measures of the physical parameters. A third of the book is used to illustrate common food materials (milk, fruit juices, chocolate, fats, and cheese) response in usual instruments and how the results can be interpreted. The book could be more helpful if references would have been provided, not only to document what the author said, but also to direct the interested reader to sources of more information on select subjects.

This book would be good for someone embarking on basic research on food rheology but then must be followed by other texts or articles which are more specific and in depth for the particular application. Another reason for reading the book would be to assist someone having a problem trying to explain an inconsistency between instrument readings and description of material's structure. It is a book which the rheology researcher should read at least once to get the big picture.

Dr. Gerald H. Brusewitz

*Department of Agricultural Engineering
Oklahoma State University
109 Agricultural Hall
Stillwater, OK 74078*

Microbiology of Frozen Foods, Edited by R.K. Robinson, Elsevier Science Publishing Company, New York, 1985. 290 pages.

Microbiology of Frozen Foods, edited by R.K. Robinson, Ph.D. is a well documented review of frozen food processing and marketing systems. Frozen foods have become an important and larger segment of the foods consumers purchase in the grocery store. Frozen food ingredients that the food manufacturing industry incorporates

into the products they market now is very significant. Freezing prepared meals and foods in foodservice also is an important process step. This book is very timely for these reasons. Food scientist, whether student or quality assurance director should have this concise (290 pages) book on frozen foods available for study and reference.

Dr. Robinson of the University of Reading has compiled eight chapters, including his, on freezing for the catering industry, written by twelve other food scientists from the U.K., Denmark, New Zealand, South Africa and Nigeria. A substantial reference section following each chapter helps provide substance to this very worthwhile book on the microbiology of frozen foods. The text is well written in logical sequence and the illustrations and tables compliment the text.

The first three chapters deal with the basics of food freezing technology, the effects of freezing and thawing on foods and on the microorganisms contained in the frozen foods. Not only are the many aspects of freezing on the microbiology of foods reviewed, but also the physical and chemical characteristics of frozen foods are discussed.

The microbiology of frozen meat and meat products, fish and related products, dairy foods, and meals of foodservice are covered. The most extensive coverage is on meat and fish. Freezing dairy foods is not covered to the extent many people might prefer. Frozen vegetables, fruits and other miscellaneous foods are not included in this book, an unfortunate omission.

Freezing meals for food service is covered rather briefly, but adequately, in one chapter. The last chapter deals with the laboratory examination of frozen foods including the details of sampling, sample preparation and dilution; as well as sublethal injury to the microorganisms in food. The methods of enumerating aerobic bacteria including psychrophiles (psychrotropes), *E. coli*, *Staph. aureus*, *Salmonella* spp., *Cl. perfringens*, *Bacillus cereus*, and *Vibrio parahaemolyticus* are reviewed.

The book is a very good reference text for food scientists involved in quality assurance in food and food ingredient processing as well as food service. This book also would make a good basic text for food science students.

W.S. LaGrange

*Dept. of Food Technology
Iowa State University
Ames, IA 50011*

Food Sanitation: Study Course, Anna Katherine Jernigan, 1984, ISU Press, Ames, IA

Past commissioner of Public Health, State of Iowa, Norman Pawlewski states:

"This study course is designed for persons already employed in food service or as a training aid for dietitians, dietary consultants, or food service managers."

"It is the hope that this study course will assist in pro-

viding superior in-service training programs for food service departments in our state and elsewhere."

The study course goal "is to train food service employees in the use of sanitary procedures to prevent food poisoning and to serve properly cared-for food in attractive, clean dishes and glassware."

The manual contains thirteen chapters in basic food sanitation, each from two to five pages in length. At the end of each chapter is a ten question review. Answers to the review questions are printed in the back of the manual.

A final review and evaluation requires the participant to list at least one point from each lesson that was new information to them, and to list changes the participants made in their own establishments from information learned in the course. Also included is a guide for preparing a cleaning schedule chart.

The chapters are brief, factual, easy to read, and pertinent. The only exception is in the chapters dealing with dishwashing and warehousing procedures. Manual dishwashing instructions should have been included along with the dishwasher information.

A comment is made in the chapter on warewashing about using 2 compartments of a sink to clean utensils. In reality three compartments are required to properly wash, rinse, and sanitize utensils.

At the completion of the *Study Course*, a certificate of recognition is given to the participant by the Iowa State Department of Health.

I would recommend this study course manual especially for in-house training of food service workers.

Food Sanitation has been approved by the Iowa Dietetic Association.

Kevin Anderson, R.S.

*Ames Health Dept.
Ames Depot
Ames, IA 50010*

The Quality of Frozen Foods, Mogens Jul.
Academic Press, New York, NY. 1984. 292 pages.

This book is the result of a workshop entitled "Frozen Foods as Viewed by the Consumer" in late 1980. The author states that the book was written to illustrate some of the uncertainties and perhaps some misconceptions, which exist in the area of frozen foods.

The book includes an introduction to food freezing, quality and nutritional aspects of freezing, early research investigations, freezing rates, product changes during freezing, time-temperature-tolerance (T-T-T) aspects, product-process-packaging (P-P-P) factors, T-T-T/P-P-P combined effects and research needs, shelf life studies, components of the freezer chains, labeling, energy, cost of freezing and effects of thawing.

The author has included extensive references to both current and older research literature. Professor Jul has

compiled an impressive reference list at the end of the book. In many instances, the author disagrees with published literature. However, this feud adds spice to a very technical book.

Many of the examples and references presented throughout the book are based on Scandinavian findings from meat and fish freezing studies. The remainder of the technical information provided is the result of the extensive experience of Professor Jul, previous Danish books ("Industrielt Levnedsmiddelkonservering 1-3" and "Konserveringsteknik 1-2") and American journal publications.

Professor Jul attempts to clarify many misconceptions about the quality and nutritive value of frozen foods. This is accomplished in the first half of the book. The second half of the book is highly technical, including extensive literature references and difficult reading, directed in my opinion to the research scientist. The food industry can benefit from the first half of this book. The readers will be treated to a refreshing discussion about freezing rates and the current dilemma of freezing fast versus slow.

Research scientists, university faculty members and quality assurance professionals in the frozen food industry will benefit from this publication.

Ricardo J. Alvarez, Ph.D.

*Corporate Director, Quality Assurance
Pizza Hut, Inc.
P.O. Box 428
Wichita, KS 67201*

NOW **MARS**

HEPAC AIR CURTAIN

Assures Highest Standards of Air Filtration

- Removes Air-Borne Bacteria, Tobacco Smoke and Other Contaminants

High Efficiency Particulate Air Curtain The MARS HEPAC Air Curtain prevents contaminated air from penetrating any room where clean air is critical, while it constantly cleans the air, removes bacteria, tobacco smoke and filters out particles as small as 0.3 microns. Easy-to-install inside and above the door opening of the room being protected—needs no structural changes. Includes H.E.P.A. filter and prefilter. For use anywhere clean, filtered air is needed. Immediate Delivery. For brochure or information write or call:



MARS Sales

17920 S. Figueroa Street
Gardena, California 90248
(213) 770-1555 Outside CA 1-800-421-1266

Please circle No. 181 on your Reader Service Page

DAIRY AND FOOD SANITATION/AUGUST 1986

Improve Product Safety and Quality

Identification and Control of Microbial Contamination Will Increase Product
SAFETY AND QUALITY

Use of THE TRU-TEST LINE and TANK SAMPLER
allows Aseptic sampling for accurate analysis.

TRU-TEST LINE SAMPLER



Microbiological Analysis is
Only as Accurate as the sample.

TRU-TEST TANK SAMPLER



The TRU-TEST Sampling
system will Increase
confidence in your data.

ACCURATE SAMPLING & EFFECTIVE MONITORING



Accurate Sampling will result in
Cost Effective monitoring.

THE TRU-TEST SAMPLING SYSTEM

- CIP Cleanable
- Pressure and Temperature Safe
- Aseptic Design

For complete information, contact:

TRU-TEST™ ASEPTIC SYSTEMS*
QMI FOOD & DAIRY QUALITY
MANAGEMENT, INC.

245 E. Sixth Street, St. Paul, MN 55101
(612) 228-0474

*Manufactured for Food and Dairy Quality Management, Inc. under license from Galloway Trusts, Neenah, WI. U.S. Patent No. 3,779,082. Canadian Patent No. 975,401. Patented 1975.

TWO BOOKLETS TO HELP YOU IN YOUR FIGHT TO MAINTAIN A PREVENTIVE SANITATION PROGRAM!

The All New 1986 Huge Pest Control Catalog
Is FREE To You TODAY!

The **Hugé Pest Control Catalog** gives you up-to-date information on pesticides formulated specially for the food industry. An invaluable tool in preventive sanitation, our catalog discusses new industry developments such as Crack & Crevice Treatment and Ultra Low Volume Applications.

The Hugé Catalog is designed to satisfy all your sanitation needs. You'll find sections on: Crawling Insect Control, Flying Insect Control, Stored Product Pest Control, Bird and Rodent Control, Fogging and Spraying Equipment, Housekeeping Aids, Miscellaneous Sanitation Aids and Hugé Company Services.

As an added feature, the catalog's centerfold identifies the most common insect pests in food operations. The pests are colorfully illustrated in their most economically destructive stages. A special section detailing EPA/FIFRA information regarding pesticide usage and certification/recertification also is included. Send for your **FREE** copy now!



Concerned About "Measuring Up" To FDA Requirements?

Your present plant sanitation level may not be up to FDA requirements. Continuous preventive sanitation is just sound business practice. Don't let government action cause you embarrassing or damaging consequences. You should know your TRUE sanitation level from an outside, tough, objective perspective.

Return this card for a free copy of our brochure detailing sanitation audits, usage of an outside consulting firm and the benefits derived to help keep you in compliance with FDA regulations. Or call our toll-free number to schedule a trial survey (1-800-325-3371).

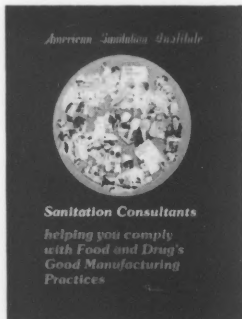

SPECIAL BONUS! \$10 off registration fee for one of our 3-day sanitation seminars—Sept. 29-Oct. 1 in Cherry Hill, New Jersey, or Dec. 8-10 in Dallas, Texas. Check here for more information.

Please send me my free copy.

(Name) _____ (Title) _____

(Company) _____

(Street) _____ (City/State/Zip) _____ (Phone) _____

Send this form or a copy to: The Huge Company, Inc./American Sanitation Institute, 7625 Page Blvd., St. Louis, Missouri 63133. Phone: (314) 725-2555.

Equipment / Supplies

Will Package Under Your Label
Ice Cream and Aerosol Whipped Cream.
Contact: Carole Hobson



Howard Johnson's
180 Old Colony Avenue
Wollaston, MA 02170
(617) 847-2387

1971 FORD TANDEM

Hackney ice cream body. 22 foot. Lift gate across back. Refrigeration plates in ceiling. Electric plug-in. 3 H.P. compressor. Truck also has over the road generator.

1981 CHEVY DIESEL

Hackney ice cream body. 6 doors, with plates. 3 H.P. compressor.

DAIRY RICH ICE CREAM CO.
6510 Broadway
Merrillville, IN 46410
Phone: (219) 980-0800
Ask for Paul

- 20 & 30,000 gallon silos
- Coldwalls 4,3,2,000 gallon
- (7)—4,000 gallon tanks with stainless steel heads
- CB & CP & York Heat Exchangers
- Kettles, Agitators 600 gallons & smaller
- CB Rotary Filler with 10 spouts
- CB-660 Filler
- Fittings up to 4" valves. Pumps

CARMEL EQUIPMENT
246 Beacon Ave.
Jersey City, NJ 07306
(201) 656-4030



Stainless Steel Single Shell Powder Hopper
APP: 8000 GAL Price \$7500

Waukesha 55 & 125 Positive Pumps
Darnow #5000 Fine Saver ... \$5000
Frick Rotary Booster Ammonia Compressor 75 hp Model 80 BAZ
..... \$3000
CP 500 Gal. Processor Pressure Wall.
Two Piece Cover \$5000

Eaton Equipment

P.O. Box 55 BOSCobel, WI 53805
HIGHWAY 133 • EAST OF THE AIRPORT

DON EATON

608-375-2256

LOEB EQUIPMENT SUPPLY CO.
4131 S. State, Chicago, IL 60609
Phone: AC 312-548-4131
TELEX: 254708 TELESERV DFLO

NEW IN STOCK

GROEN 150 gal. s/s twin agitated Kettle
URSCHEL 2100 Comitrol
AIR PRODUCTS, s/s Cryogenic Screwfeeder
SWECO 18" diam. single deck sifters—2 available.
SIMPLEX s/s dual twin 4 head Piston filler—18 oz. max. fill/piston
C-B Auto Fruit leeder
VIKING R-2000 Auto T&B Random case sealer w/ hot melt
ICORE continuous motion checkweigher
CAMTRON F&B Auto Roll-On pressure sensitive labeler—new: 1980
PERRY CMR-124 s/s CM Rotary vacuum powder filler
LOCKWOOD Vegetable Brusher/Desprouter
BIRO 7 1/2 hp. s/s Meat mixer/grinder
CREPMATIC 6" x 8" diam. Auto Crepe maker
BAUER s/s Auto Pan greaser
2500-9" 18 Prong s/s Bacon hangers
Western States Q-320 T316 s/s sludge-a-tron basket Centrifuges—3 available
MULTIVAC Type M30 single chamber vacuum packagers—2 available
NEW—VISUAL THERMOFORMING DS-4-F 4 station Blister sealer—good for food trays
ANDERSON C-400 Auto capper—new: 1982
JONES CMC-200 Tuck cartoner
SOLBERN OTF Filler for delicate products—overhauled: 1982

WE ARE ALWAYS INTERESTED IN PURCHASING GOOD SURPLUS EQUIP. CONTACT LOEB AS YOUR REQUIREMENTS CHANGE

Attention:

BREDDO HIGH SPEED BLENDERS

Available in All Sizes From:
25 gallons through 300 gallons
CHOOSE FROM
Complete Inventory Including
Single Wall or Jacketed Units

Contact: **BREDDO LIKWIFIERS**
18th & Kansas
Kansas City, KS 66105
800-255-4092

PACKAGING MACHINERY

Manufacturing of the Original LYNCH Packaging Machines.

Whether it's Ice Cream Sandwiches, Ice Cream Novelties, Butter, Oleomargarine, Cheese or other Dairy Products, HPS, Inc. has precision, 'tailor made' economical machinery capable of using various types of wrapping materials.

MORPAC SMW Ice Cream Sandwich Machines
MORPAC MBW Frozen Novelty Bars - Square, Rectangle, Round
MORPAC Butter Printer and Wrapper
MORPAC Cartoners
WRAP-O-MATIC Models: 20, 25, 27, 30, also PB and RA wraps multiple pieces with automatic flat card or boat former and product feeders.
"BOTTOM-SEAL—DIE FOLD" WRAPPING METHOD" gives an attractive package for irregular, odd-shaped, fragile, or uniform products.

HEINLIN PACKAGING SERVICE, INC.

3121 South Ave., Toledo, Ohio 43609

419/385-2681

Equipment / Supplies

BREWERY TANKS FOR SALE

Located Milwaukee, Detroit and Cincinnati... over 800 BLUE GLASS LINED, EPOXY LINED AND STAINLESS TANKS... with capacities up to 41,320 gallons each!
All tanks bargain priced... for "next day" shipment.
Send for free Tank List: #SDL/REV.

"TANK KING"
B & B Equip. Corp.
Box 1530, Tampa, FL 33601
(813) 228-7888 Telex 52481



SELECT ITEMS- IN STOCK

S.S. Jet Type COP Circulating Tanks
Assorted S.S. Wash Tanks
CIP Systems
Tank Truck Washers
S.S. Work Tables, Carts and Sinks
Mixing Units/Hose Stations for Clean-up
HERITAGE EQUIPMENT COMPANY
3200 Valleyview Drive
Columbus, Ohio 43204 (614)276-0187
Surrounding States Wats 1-800-282-7961
Ohio Only 1-800-282-2997

BRINK'S INC.

INDUSTRIAL PROCESSING EQUIPMENT
AND SUPPLIES
— 8 x 9 DeLaval Contherm, Excellent Condition
— DeLaval Triple Tube Heat Exchanger
— Cherry Burrell Plate Heat Exchanger, 215 Plates
— Storage Tanks 1000 up to 7000 gallon
— 7000 Gallon S/S Refrig. Storage Tank
— 6000 Gallon a/l Lined Sugar Tank
— 5000 Gallon Vertical Single Wall Syrup Tank, S/S
— 4000 Gallon Epoxy Lined Sugar Tank
— 4' Parts Washer with 3 HP Pump
— Vilter Compressors Model 446 & 448 Level 1,
Factory Remanufactured, New Warranty
MCT'S Gaulin Homogenizer
Girton Model 664R Tray Washer, 2 cycle, Recirculated
wash, fresh house water rinse

P.O. Box 509, Knoxville, TN 37901
(615) 584-4684

JILCO EQUIPMENT

Cranbury N.J.
Sales—Leasing

DAIRY REEFERS
Milk and Ice Cream
New or Reconditioned
ThermoKing Diesels or D/E
Tank Floors
Our Specialty
609/655-5001

All types Sanitary positive pumps rebuilt.
Mutators & barrels rebuilt. Call or send for free literature.



POLAR CONTAINER CORPORATION

5259 Rose Street Rosemont, Illinois 60018
(312) 671-6080 OR (312) 671-6081

SPECIALIZED SERVICE FOR THE ICE CREAM MANUFACTURER

SELECT used machinery

DAIRY EQUIPMENT NEEDED
M & E will purchase your used equipment, either complete plants or individual items

We are THE Liquidators
and
We Come With CASH
Call Don Rieschel

MACHINERY & EQUIPMENT CO.
PO BOX 7632-W SAN FRANCISCO, CA 94120
TOLL FREE: National 800-227-4544
California 800-792-2975
Local & International 415-467-3400
Telex 340-212

1—5000 gal. cold wall tank
1—lot of 1" -4" pipe valves & fittings
1—500 gal. complete H T S T w homo
2—6000 gal. milk storage tanks
2—600 gal. processing vats
1—1000 gal. conventional starter vat
1—3500 Damrow deep make vat
1—1000 Gal. pressure wall vat
1—6000 Gal. cold wall tank
1—10,000 gal. rectangular cold wall tank

Midwest Food Supply Co.

504 Clay St., Waterloo, IA 50704
(319) 234-5554

BOTTLE FILLERS, All kinds.

Call us collect anytime for over
the phone quotations. Contact:

Jon Fogg FOGG FILLER CO.

37 Van Dyke St., Holland, MI
49423
(616) 392-1808

EQUIPMENT FOR SALE

5 Gallon Stainless Steel Dispenser
Cans

400 Gallon Mojonnier P.W. Processor,
#7 Finish Inside

Rebuilt 370 DeLaval Gaulin and C. B.
Homos

Girton Sales Co.
Millville, PA 17846
717-458-5551

SELECTED NEW—USED RECONDITIONED

STORAGE TANKS

Cherry Burrell Model DHS 4,000 gallon
Ref. Horz. Cyl.
Cherry Burrell Model DHC 3,000 gallon
Ref. Horz. Cyl.
Cherry Burrell 1000 gallon Ref. Vert.
Cyl.

PROCESSORS

Crepaco Model BIB 1,000 gallon p/w
Cherry Burrell Model WPT 600 gallon
Pfaudler 500 gallon
Groen Model TA60SP Kettle

HOMOGENIZERS

Gaulin Model CGD 1,000 gph
Gaulin Model CGE 800 gph
Gaulin Model E 300 gph

MISCELLANEOUS

Anderson Model 640 Filler
Schluster Model URWJ Parts Washer
Hobart Model V1401 Mixer

ILLINOIS CREAMERY SUPPLY CO., INC.

4101 N. Rockwell St
Chicago, IL 60618
312/588-6300

Services / Products

Guaranteed Heavy Duty — fiberglass — FLOORS, WALLS and TANK LININGS

Our installed systems feature: nonslip
floors; smooth seamless walls; high
chemical, corrosion and impact resis-
tance; fast set up and exceptional sanita-
tion qualities.

- USDA approval, all insurance coverage
- Professional installations since 1962
- Our fiberglass installations cost less and they are constructed to stay that way
- We try to do more for your bottom line

M&W Protective Coating Co.
912 Nunn Ave. • Rice Lake, WI 54868
Ph. (715) 234-7894

Services / Products

GOSSELIN & BLANCHET
Butter-Making Equipment.
New and used. Sales. Service. Parts. **B & J REPAIR SERVICE** • 4818 N. Bailey Rd. • Coral, MI 49332 • (616) 354-6629.

COMPLETE LABORATORY SERVICES

Ingman Labs, Inc.
2945-34th Avenue South
Minneapolis, MN 55406
612-724-0121

PERRY...THE DAIRY PROFESSIONALS

Nimco 550 S.S. 1/2 to 1/2 gal.
Nimco 5110 E.S.S. Eco Pack
Haskon model 340, 74 OU
FMC Mod. SSE & 75 juice finishers
Westfalia Md. SAMN 15037 desludger
Excella Q-80 S.S. 1/2 p. to qts.
Gaulin M-45 100 HP, 1250 at 8,000 psi
Uniloy 350R4
Kautex, KEB 8, 2 Hd.
500 Gal. Groen Kettle, dbl. mot. scraper, 316SS

WE TURN YOUR IDLE ASSETS INTO CASH!

PERRY/ EQUIPMENT
CO. INC.

Box DF, Hainesport, N.J. 08036
Phone: 609-267-1600



**Peterson Fiberglass
Laminates, Inc.**

*The Original Fiberglass
Brine Tank People*
**Serving the Cheese Industry
since 1957**

300 Starha Drive
Shell Lake, WI 54871
(715) 468-2306

CAPITOL VIAL CORP. INTRODUCES THE AVOC-20

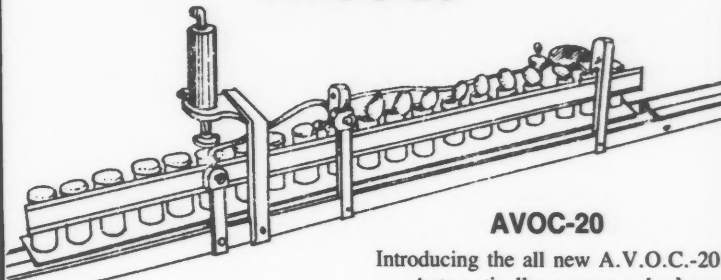

AVOC-20

Introducing the all new A.V.O.C.-20
— Automatically opens and closes
Capitol hinged cap vial — Fits all
Multi Spec and Foss-O-Matic testing
equipment.

CAPITOL VIAL CORP.

P.O. Box 611
Fonda, NY 12068

free video tape available upon request, phone:518-853-3377

Benefit from Knowledge of Industry Experts

**REDFERN
& ASSOCIATES**

Upcoming Annual Courses

Improving Productivity in the Dairy Industry/Sept. 22-24, 1986, Raleigh, N.C.

A presentation of proven techniques, using actual case studies on how to improve productivity (Production Planning, Maintenance Planning, Safety Planning, Laboratory Management, Waste Management, Butterfat & Milk Volume Accounting).

Refrigeration, Equipment and Maintenance/Oct. 13-16, 1986, Raleigh, N.C.

A course on how to save on refrigeration, energy and equipment maintenance. Learn by doing and observing (ice cream freezers, packaging, and refrigeration systems).

Freezing, Packaging and Sanitation of Novelties/Nov. 10-12, 1986, Raleigh, N.C.

Presents up-to-date procedures on freezing and packaging novelties, proper cleaning and sanitation procedures and waste management.

Fluid Milk Technology/Jan. 26-29, 1987, Raleigh, N.C.

A course developed to train the person on the job the skills necessary to operate a profitable fluid milk processing plant (receiving through filling).

Ice Cream Technology/February 16-19, 1987, Raleigh, N.C.

Our most popular course in its fourteenth year. Everything you need to know about ice cream formulation and mix making, freezing and hardening, packaging, sanitation, flavoring and tasting. This year a special section on the operation of Ice Cream Stores.

Enrollments Are Now Being Accepted!

Program participation in each course is limited. Course details available upon request. Contact Ms. Terry Johnson at (919) 787-8496 for immediate response or write to:

Redfern & Associates, P.O. Box 31108, Raleigh, N.C. 27622

Services / Products

Employee Training Materials for Food Plants



- GMP booklets and slides in English and Spanish
- Sanitation booklets and slides

LJB, INC.

Associated with L.J. Bianco & Associates
Food Quality Control & Assurance Consultants
850 Huckleberry Lane
Northbrook, IL 60062
312-272-4944
35 Years Food Operation Experience

DISTRIBUTORS WANTED:

Unique opportunity to take charge of the future today. Hi-Tech Chemical Research has developed the SUPER CONCENTRATE, 8 to 10 times more active than standard concentrates. 5-gallon pail is equivalent to 55-gallon drum and 16 ounce bottle equals 1 gallon; dilutions as much as 1 part SUPER CONCENTRATE to 1000 parts water. COBRA, MAS, THUNDER, FX-400, BULLDOG, CONVOY and more. Save \$\$\$, space, handling, freight. Write: **Despo Chemicals International, Inc.**, 395 Front St., Perth Amboy, NJ 08861, or call (201) 826-0100.

WCR INCORPORATED

Plate Heat Exchanger Regasketing Service

4740M Interstate Drive
Cincinnati, Ohio 45246
513/874-3345

2820 East Church Avenue
Fresno, California 93706
209/266/8374

STERILE SAMPLE VIAL



One piece 45 ml vial, easy one hand handling, durable, resists cracking, food grade polypropylene.

Phone: 518-853-3377
For samples call or write:

Capitol Vial Corp.
P.O. Box 611
Fonda, NY 12068

COMPONENT SAMPLES FOR CALIBRATION OF INFRARED TESTERS

Samples are also designed to be used as daily performance checks.*

1 set of 12 in duplicate	\$60.00
Add. sets same week/same address	\$30.00
Skim sample	\$ 5.00

*1 set equals 2 calibration or 4 daily checks

Call for more information (612) 484-7269

DAIRY QUALITY CONTROL INSTITUTE, INC.
2353 No. Rice St., St. Paul MN 55113

WE'RE IN THE MIDDLE OF THE NEW YORK MARKET

We are experienced packers of Syrups, Juices and Juice Drinks and many liquid products. Glass or Plastic Bottles. Long or Short Runs.

(201) FOOD PACKING, INC.
1501 Park Ave., Linden, N.J. 07036
(201) 925-8890

Employment Opportunities

ATTENTION: DAIRY PROFESSIONALS

Dunhill of Southeast Fort Worth, Inc. has over 40 job openings in all areas of the dairy profession. Company paid fees, relocation and interview expenses. You may qualify. Examples:

ASST. PLANT ENGR. - ICE CREAM	NORTHEAST	TO \$30K
Q. C. SUPERVISOR	SOUTH	TO \$29K
PLANT MGR. - FLUID	SOUTHWEST	TO \$40K
Q. C. SUPERVISOR	MIDWEST	TO \$35K
PLANT MGR. - ICE CREAM	SOUTH	TO \$45K
FOOD TECHNOLOGIST	SOUTHEAST	TO \$20K
Q. C. MANAGER	MIDWEST	TO \$43K
FOOD SCIENTIST	NORTHEAST	TO \$43K
Q. A. TECHNOLOGIST	SOUTHEAST	TO \$24K
Q. A. TECHNOLOGIST	EAST	TO \$24K
Q. C. MANAGER	SOUTH	TO \$34K
SHIFT SUPERVISOR - FLUID	NEW ENGLAND	TO \$28K
Q. C. TECHNOLOGIST	SOUTHEAST	TO \$21K
Q. C. SUPERVISOR	NORTHEAST	TO \$35K

Send resume in confidence to:

Mr. Dana S. Oliver, President

The National Personnel System

Dunhill.

PERSONNEL SERVICE OF SOUTHEAST FT. WORTH, INC.

P.O. Box 6397
Fort Worth, Texas 76115-0397
or call 817/926-7284

The Marketplace

Cheese Technologist \$32,000
BS Dairy Science with several years exp. in Cheese Research and Product Development, Formulations, Process development and Aseptic Processing.

Food Technologist - Ice Cream \$30,000
BS Food Science with 2-3 yrs. exp. in Ice Cream and Frozen Novelty Product Development.

Quality Control Manager - Cheeses \$28,000
BS Food Science or Dairy Science with 3-5 yrs. exp. in Cheese Processing QC.

Research Technologist - Cheeses \$25,000
BS Food Science or Dairy Science with 2+ yrs. in Cheese Development.

Call:

TOM HENRY
Henry-Wallace & Associates
30 Patewood Drive, Suite 302
Greenville, SC 29615
803-234-7081

Let us help you with your recruiting needs.



TOM SLOAN

& ASSOCIATES, INC.
LICENSED EMPLOYMENT AGENCY

OUR FUNCTION IS YOUR FUTURE

ALL FEES ARE COMPANY PAID

Contact Tom Sloan
Call or send resume to:
727 Lafayette St., Watertown, WI 53094
Telephone 1-414-261-8890

Employment Opportunities

W CONSIDERING A
NEW POSITION?
Now that you have decided to
look for a better opportunity,
contact Whittaker first!

QC/QA Supervisor	25-35K
IC/QC Manager	25-30K
Sanitarian	25-35K
Technical Manager	45K
Beverage Technologist PhD	50-55K
Sanitation Supervisors	25-29K
Director of QC	30K
Lab Techs	20-24K
Regional Sales Managers — Cleaners	30K + C + B
Regional Sales Managers — Stabilizers	30K + C + B
QC/R and D Manager	30-40K
Corporate QC Director — Multiple Plants	48K

Call or Write
Arnold Whittaker
or
John McCauslan

WHITTAKER & ASSOCIATES
2675 Cumberland Pkwy., Suite 263
Atlanta, Georgia 30339, Phone: 404-434-3779

The Christiansen Group

THE CHRISTIANSEN GROUP specializes in the recruitment/placement of Food and Beverage industry professionals on a nationwide basis. The following is a list of a few of our most immediate needs:

Sr. Project Engineer	to \$48,000
(B.S.M.E. or related, desire 5+ years project engineering experience, will supervise 2 jr. level engineers, Pacific Northwest location.)	
R&D Manager	to \$70,000
(Ph.D. preferred, R&D responsibility for major division of Fortune 100 company, good visibility.)	
Group Plant Engineer	to \$50,000
(B.S.M.E. or related, seek 8+ years plant/project engineering exp., day to day plant responsibility & oversee project work at 3 plants.)	
Chemists	to \$34,000
(B.S. — Chemistry preferred, desire 2+ years bench top chemistry exp., division level, lipids knowledge helpful.)	
Maintenance Sup'vs	to \$40,000
(B.S. preferred, seek 5+ years maintenance sup'v experience, high-speed bottling/canning helpful.)	
Packaging Sup'vs	to \$38,000
(B.S. preferred, high-speed packaging environment, bottling/canning, union environment.)	
Production Manager	to \$50,000
(B.S. required, desire 8+ years exp. in baking operation, sup'v 10 salaried & 250 hourly, southern location.)	

SCOTT CHRISTIANSEN
The Christiansen Group
Two Corporate Centre, Suite 100
Springfield, Missouri 65804
(417) 883-9444



HELP WANTED:

Your Dairy or Food Experience Needed

I work closely with Dairy and Food companies across the entire U.S.. These companies are in need of experienced people like yourself. My contacts and 30 years of Dairy and Food experience will help you find the companies you can grow with.

Call or send a resume to:

We offer:

- Complete confidentiality
- Immediate response
- Company Fee Paid positions only
- Openings in many positions

Lee Stannard
Dunhill of Iowa City, Inc.
1233 Gilbert Court, Suite A
Iowa City, Iowa 52240
(319) 354-1407



MANUFACTURERS REPS WANTED

Well established manufacturer of quality equipment for over 50 years seeks representatives for marketing Case/Container Washers, Process Heating Equipment and other quality products in the Dairy and Food Processing Industries. Openings available in several territories. Please advise territory, existing lines and qualifications.

CONTACT: G. C. Evans Co., Inc., P.O. Box 1124, Little Rock, AR 72203, 1-800-382-6720.

* * * * *

THE WINCHELL CO.

* Plant Engineer (Milk)	to \$35K
* Maintenance Supvr. (Milk)	to \$28K
* Director of Quality Control	to \$40K
* Asst. Plant Mgr. (Ice Cream)	to \$30K
* Quality Control Supvr.	to \$25K
* Milk Plant Supvrs. (5)	to \$28K
* Ice Cream Plant Supvrs. (6)	to \$30K
* Sales Mgr. (Ice Cream)	to \$35K
* Milk Plant Mgr.	to \$40K
* Cultured Products Supvr.	to \$28K
* Ice Cream Plant Mgr.	to \$45K

CALL TOLL FREE
1-800-438-4531
or send resume to:
THE WINCHELL CO.
P.O. Box 2349 • Charlotte NC 28211

* * * * *

Consulting Services

GHK ASSOCIATES



Providing Training and Consulting Needs in the Following:

- Food Processing
- Food Service
- Institutional Food Service
- Milk Sanitation
- Retail Food Store Sanitation

Harry Haverland, MPH.
D. W. Kaufmann, Ph.D.
Richard Gillespie, MPH.

12013 CANTRELL DR.
CINCINNATI, OH 45246
PHONE: 513/851-1810

Position Wanted

Technical/Product Manager With 17 Years Experience In Applied Research/Product Development and 7 Years Experience in Management Seeking Growth Position in Food Science, Enzyme-Fermentation Technology or Cheese/Dairy Flavor Technology. Resume Upon Request. Will Relocate.

IAMFES, P.O. Box 701, Ames, IA 50010

Attention: Bob Clark

Consulting Services

DR. R. H. ELLINGER & ASSOCIATES Consultants to Food Industry — Domestic — International

Research & Development

- Consumer Products
- Foodservice Products
- New Formulations
- Product Improvement
- Consumer Testing
- Experience in:
 - frozen foods
 - bakery products
 - prepared mixes
 - dairy products
 - sauces & dressings

R. H. Ellinger, Ph.D.
(312) 272-6376

Regulatory Compliance

- Legal Assistance Available
 - through Associate
 - expert food law attorney
- Labeling Compliance
- Food Safety Regulations
- Product Recalls/Seizures
- Adverse Inspections
- Port-of-entry Detentions
- Regulatory Negotiations
 - FDA, USDA, U.S. Customs
 - State, Local agencies

Quality Assurance

- USDA Approval
- QA Audits
- Statistical QC
- Computerized QC Data
- Expert Court Witness
- Approved Procedures for:
 - HACCP
 - GMP/plant/warehouse
 - consumer complaints
 - sanitation
 - pest control

3946 Dundee Road
Northbrook, IL 60062

Want to Buy

WANT TO BUY: Vitalines, Amerios & Big Cherry Freezers (any size or condition) 318-435-4581. Lamar Johnson, Caleb or Ronnie. We buy ice cream plants complete with accounts, equipment and routes. Will lease or buy real estate. Confidential telephone number: 318-435-9696. Only Caleb Martin answers.

WE BUY USED GAULIN HOMOGENIZERS: Girton Sales Co., P.O. Box 901, Millville, PA 17846, 717-458-5551.

Replacement Parts

Martin Brothers

816 ADAMS—BOX 630
WINNSBORO, LOUISIANA 71295
Bill (318) 435-4581 Caleb

OUR EXPERIENCE/SKILL & ENTHUSIASM
BUILDS & SELLS BETTER EQUIPMENT

REBUILT FREEZERS: Tested and Set actual on Ammonia Operation - Improved Ammonia Control, Hard-Chrome Pump Housings - Available Now.

3090 Cherry 3 Bbl - 1200 GPH - Rebt. & Updated
603 Cherry 3 Bbl - 900 GPH - Rechromed
VS400 Cherry Star - 500 GPH - Rechromed & Foamed
VA300 Admiral - 300 GPH - Rechromed & Foamed
V20300 Commander - 300 GPH - Rechromed & Foamed
VS200, VA150, V1D150 - Rebt., Rechromed & Foamed
3M15 Crepacco 3 Bbl
M10 Crepacco SS Freezer 40-80 GPH

WESTPHALIA SEPARATOR - CLARIFIER

Model 20006 - Serial #1628327 - 35 HP
230/460 Volt - Bowl 6,000 RPM
60,000 # Warm Milk - 50,000 Whey was operating at 21,000 #
Excellent Condition - \$7,000 spent on Bowl recently
..... \$19,500

2,000 Gal Vertical Cold-Wall Tank - Ammonia \$4,750
3-500 Gal Milk Haul Tanks insulated and with Manhole 4' Wide
2-#648 Thermaturator - Rebt. Barrels - Some Mutators Pure-Aire Machine for Dry Air System \$2,500

FOR BARGAINS CALL BILL MARTIN - Ext. #31 - Flo Diversion Valves - New 39VJ3 rebt. 39VJ2, 39VJ3, 1310, 7334 (3) G & H CIP Air Diversion Valves 1 1/2" \$495 each - Motor Driven Ripple Attachment - Air Eliminator for Siemens Meter \$150 - 3" 3-Way Valve \$750 - Ask about Air Valves - Thermaturators - Mercoids and Penn Controls.

200 gal. stainless steel Single-Shell Mixing Tank
Triangle Filter DS-1 for Yogurt 8 oz. Cups
COP Wash Tank 33" x 50" 5 HP Motor Pump on Casters
COP Pipe and Fitting Wash Tank 12 ft. Long 3 HP Motor
..... \$1,750
1000 Gal. rec. Hold Tank, ref. with ss front Ice Water
Extra CP Crescent Plates for Crepacco HTST or Heat Exchanger
Several small Crescent Heaters or Coolers Crepacco & other brands
Lab Moisture Tester Brabender model FD \$300
Can Filler Cherry-Burrell 5 gal. or 10 gal. with 20 gal. Tank
Turner Pre-Wired Control Panel for Engine Room or Plant addition or New Plant
Grace Cottage Cheese Blender, 100 gal \$2,250
Hobart Garbage Disposal, 5 HP, in good condition
2 Shelf Electric Oven, Vulcan-Hart
3-Compt. Steam Master Cooker by Fry-Master, excellent and will close-out

3-Compt. Steam Pressure Cooker, Market Forge Co.
3Mts sell at bargain
Sharples Clarifier, 20,000 #, almost complete, but close-out price for Parts
5 qt. and 1 gal. Akra-Pak Automatic Filler and Capper
Ice Cream and Cottage Cheese - Model VL \$9,500
Several Ammonia Blower Coils, Floor Mounted, low temp and high temp - \$500 - \$750
Recold Freon Plug Type Unit, 7 1/2 HP Freon Air Cool Compressor and evaporator, all mount thru the wall \$1,500
Freon Krack Ceiling Units, ED24, for Freon look good, low temp, electric defrost \$750 each
HOMO Frame only for MF45 with ss cover, Gaulin . \$4,750
HOMO MC18 Gaulin Two Speed - 1950/2900 GPH - Model MC18 - S#4652768 - 75 HP 3/60/220 - Belt Drive - Weight 6000# - 2 Stage HVA - Brand new Stainless Seals
HTST C.P. Pasteurizer Press - S#CX-2168 - 3000 GPH

AMMONIA

LITE ONE TESTED CANDLE

OUR EXPERIENCE/SKILL & ENTHUSIASM
BUILDS & SELLS BETTER EQUIPMENT

200 Freezers in Stock 80 to 1800 GPH
Rebuilt Admirals, Stars & 3D90's 300-1200
Back up Parts & Hotline Service

Delivery USA Martin's Rigs
603 Cherry Rebuilt 900 G.P.H. 3BBL
Flavor Tanks 3 compt. 100 & 500 gals.
Anderson Filters and Clutches Rebuilt
Only Martin tests own ammonia

ADVANCE EXCHANGES INSTANT

Rechromed freezer barrels: V1D, V1F, 150's, V2D
VA300's, VS200-400-500 Star's, V3100, 303, 403, 612, 614, 3D90, 3D121, 33D180, 6 bbl. 33D, 242, 672 Therm., C.P. KM340, 3M30, M55, M30
Stainless freezer outlets: V1D, V1F, VA 150's V2D, V2F, VA300's, VS200-400-500 Star's
Rebt. & New dashers: 603 & 612, VS500, 400 & 200—V1D—VA150—V20 & VA300
Rebt pumps some freezers new way.
Call Lamar, former I.C. Plant Mgr.

Martin Brothers

816 ADAMS—BOX 630
WINNSBORO, LOUISIANA 71295
Bill (318) 435-4581 Caleb

VITALINE REBILT UPGRADE
"No bad deal from good dealer"

Abstracts of papers in the August Journal of Food Protection

To receive the Journal of Food Protection in its entirety each month call 1-800-525-5223, ext. A or 515-232-6699, ext. A in Iowa.

Evaluation of Methods for Extraction of Enteric Virus from Louisiana Oysters, Mary Townsend Cole, Marilyn B. Kilgen and Cameron R. Hackney, Department of Food Science, Louisiana Agricultural Experiment Station, Louisiana State University Agricultural Center, Baton Rouge, Louisiana 70803 and Department of Biology, Nicholls State University, Thibodaux, Louisiana 70803

J. Food Prot. 49:592-595

Six techniques were evaluated for recovery of poliovirus from Louisiana oysters. The methods were compared for percent recovery rates, toxicity, ease of extraction, bacterial contamination, and final volume of oyster concentrate. Oyster samples were contaminated with 30-40 plaque forming units of Poliovirus type 1 and processed by six variations of adsorption-elution-precipitation and elution-precipitation methods. The method developed by Ellender et al. (Natural enterovirus and fecal coliform contamination of gulf coast oysters. *J. Food Prot.* 43:105-110) was judged to be the preferred method for gulf coast oysters.

Detection of Enteroviruses and Bacterial Indicators and Pathogens in Louisiana Oysters and Their Overlying Waters, Mary Townsend Cole, Marilyn B. Kilgen, Lawrence A. Reily and Cameron R. Hackney, Department of Food Science, Louisiana Agricultural Experiment Station, Louisiana State University Agricultural Center, Baton Rouge, Louisiana 70803 and Department of Biology, Nicholls State University, Thibodaux, Louisiana 70803

J. Food Prot. 49:596-601

Field studies were conducted for 1 year to determine levels of enteroviruses in Louisiana Gulf Coast oysters and their overlying waters. Levels of human enteric viruses were compared with bacterial pathogens (*Salmonella* and *Vibrio parahaemolyticus*), fecal coliform levels, and physicochemical water parameters (pH, salinity, temperature, and conductivity). Samples of 20-30 oysters and 380 L of overlying water were collected monthly from both "open" and "closed" oyster growing areas. Enteric viruses were found predominantly in January and February. Viruses were isolated only from areas which exceeded the 14 fecal coliforms/100 ml standard for shellfish harvesting waters.

Changes in Manganese Content in *Lactobacillus plantarum* During Inhibition with Sodium Nitrite, D. L. Collins-Thompson and I. Q. Thomson, Department of Environmental Biology/Food Science, University of Guelph, Guelph, Ontario, Canada N1G 2W1

J. Food Prot. 49:602-604

Lactobacillus plantarum ATCC e8014 and *L. plantarum* (MC) were sensitive to NO_2^- under anaerobic conditions. This sensitivity was linked to an increase in cell-associated manganese levels. Normal manganese levels under aerobic conditions in the presence of NO_2^- were 1×10^7 atoms/cell. Under anaerobic conditions with NO_2^- , these levels increased to 3×10^8 to 2×10^9 atoms/cell depending on the sensitivity of lactobacilli to NO_2^- . This study suggests that in trace metal metabolism, NO_2^- may stimulate uptake or transport of ions such as manganese.

Enterobacteriaceae Identification from Stock Cultures and High Moisture Foods with a Four-Hour System (API Rapid E), N. A. Cox and J. S. Bailey, U.S. Department of Agriculture, Agricultural Research Service, Richard B. Russell Research Center, P.O. Box 5677, Athens, Georgia 30613

J. Food Prot. 49:605-607

The API Rapid E is a 4-h system for the identification of *Enterobacteriaceae* that has not previously been evaluated with food isolates. A total of 232 cultures, representing 13 genera of *Enterobacteriaceae*, was used in this study; 47 were known stock cultures and 185 were freshly isolated from raw foods (broiler carcasses, chicken sausage, hamburger, scallops and shrimp). Each food isolate was inoculated into the API Rapid E and also into two other miniaturized systems (Micro-ID and API-20E) which served as the reference. API Rapid E correctly identified 219 (94.4%) of the cultures to species. Ten of the thirteen errors in identification occurred with *Enterobacter* spp. because of false-negative reactions with the Voges-Proskauer test. The predominant *Enterobacteriaceae* encountered in each food were *Escherichia coli* (broiler carcasses), *Serratia marcescens* (chicken sausage), *Enterobacter aerogenes* (hamburger), *Enterobacter cloacae* (scallops) and *Klebsiella oxytoca* (shrimp). The degree of accuracy with the variety of organisms tested in this study coupled with the 4-h incubation should make the API Rapid E a practical alternative to conventional procedures for the practicing food microbiologist.

Interrelations Among Ecological Variables in Stored Cereals and Associations with Mycotoxin Production in the Climatic Zones of Western Canada, R. N. Sinha, D. Abramson and J. T. Mills, Research Station, Agriculture Canada, 195 Dafoe Road, Winnipeg, Manitoba R3T 2M9, Canada

J. Food Prot. 49:608-614

The incidence of mycotoxins and the interrelations among ecological variables in western Canadian common and durum wheat and barley were determined using 440 railway car samples collected during 1981-83. The 41 Prairie Crop Districts represented by the samples were ranked according to the incidence of fungal infection, mite infestation and other grain quality loss criteria and grouped according to climatic subdivisions. Principal component analyses determined linear relationship patterns of ecological variables; ranking of the crop districts was done by Kendall's ranking approximation technique using the first (C_1) and second (C_2) principal components. Only five samples originating from Saskatchewan, Alberta and Manitoba contained ochratoxin A, with levels of 10-51 ppb. None of the samples contained aflatoxins, sterigmatocystin, citrinin, or penicillic acid. All samples containing ochratoxin A had established contamination of species in the *Aspergillus glaucus* group (10-86% infection level), and *Penicillium* spp. (20-80% infection level). Most of these samples had low germinability, high fat acidity levels and were infested by stored-product mites including, *Acarus siro* complex, *Lepidoglyphus destructor* (Shrank) and *Tarsonemus granarius* Lindquist. In wheat, the C_1 accounted for 24% of the variability indicating that poorly germinated wheat was associated with the presence of *Penicillium*, *Aspergillus glaucus* group, *Wallemia* sp., and the fungivorous mites, *T. granarius* and *A. siro*. The C_2 accounted for 10% of the variability indicating that an increase in free fatty acids was correlated with a high incidence of *Aspergillus flavus* and *A. versicolor*. Pronounced C^2 interrelations for wheat were most common in crop districts lying in the Sub-humid Prairie, the northern part of the Dry Belt and the southern part of the Humid regions. Similar relationships for durum wheat and barley were also defined and ranked on maps.

Control of T-2 Toxin Production Using Atmospheric Gases, Nachman Paster, Rivka Barkai-Golan and Moshe Calderon, Departments of Stored Products and of Fruit and Vegetable Storage, Agricultural Research Organization, The Volcani Center, P.O. Box 6, Bet Dagan 50250, Israel

J. Food Prot. 49:615-617

When the fungus *Fusarium tricinctum* NRRL 3299 was grown under atmospheres enriched with 50% CO_2 and above (given in combination with 20% O_2), T-2 production was reduced to 4.0 $\mu g/45$ ml of medium, as compared with 21.2 $\mu g/45$ ml of medium produced in an atmosphere of air. At 60% $CO_2/20\%$ O_2 and 80% $CO_2/20\%$ O_2 , a significant reduction in fungal growth was also observed. The possibility of using controlled atmospheres as a means for mycotoxin control is discussed.

Growth and Toxin Production by *Clostridium botulinum* in Sauteed Onions, Haim M. Solomon and Donald A. Kautter, Division of Microbiology, Food and Drug Administration, Washington, D.C. 20204

J. Food Prot. 49:618-620

In October, 1983, sauteed onions in "patty-melt" sandwiches were epidemiologically responsible for a large outbreak of botulism in Peoria, Illinois. Spores of strains of *Clostridium botulinum* type A, recovered from Spanish onions or from patients who consumed sauteed onions, produced high toxin titers within 48 h from 2 spores/g of onions when experimentally in-

oculated into sauteed onions. Laboratory strains of *C. botulinum* type A which normally produce high-titered toxin in culture media yielded very low toxin titers and required 3 to 4 d and an extremely high inoculum of spores/g of onions. Five strains of *C. botulinum* type A were isolated from 75 raw onions obtained from the Peoria restaurant where the outbreak occurred.

Microbiological Quality of Non-Dairy Creamers, Fillings and Toppings, Donald W. Warburton and Karl F. Weiss, Bureau of Microbial Hazards, Food Directorate, Health Protection Branch, Health and Welfare Canada, Tunney's Pasture, Ottawa, Ontario, Canada K1A 0L2

J. Food Prot. 49:621-622

A study conducted in 1984-1985, in the province of Ontario, Canada, assessed the bacteriological quality of three types of non-dairy substitutes including creamers, fillings and toppings. All sample units tested contained acceptable levels of aerobic colony count (ACC), yeast/mold and aerobic sporeformers. *Escherichia coli*, *Staphylococcus aureus* and *Salmonella* were not detected in any of the 79 lots tested, indicating that good hygienic practices were used during the manufacture of these products.

Aflatoxin Estimation in Corn by Measurement of Bright Greenish-Yellow Fluorescence in Aqueous Extracts, E. B. Lillehoj, T. J. Jacks and O. H. Calvert, ARS, USDA, Southern Regional Research Center, New Orleans, Louisiana 70179 and Department of Plant Pathology, University of Missouri, Columbia, Missouri 65211

J. Food Prot. 49:623-626

A procedure was developed for efficient extraction of bright greenish-yellow (BGY) fluorescent material from ground corn (*Zea mays* L.) samples and subsequent quantitative determination of fluorescence emission in a fluorometer. The technique was designed to be inexpensive, rapid and utilizable at remote locations for estimation of aflatoxin levels. A simple, in vitro method for production of the BGY-fluorescing material from kojic acid was developed to provide a reference standard. Water was identified as an effective solvent for extraction of the BGY-fluorescence from corn; fluorescence in aqueous extracts was stable at pH 6-7 for up to 22 h at room temperature. Samples with aflatoxin concentrations of 0 to 12,000 ppb yielded BGY-fluorescence emission units of 0 to 175. A correlation coefficient of $r = 0.77$ was determined for BGY-fluorescence vs total aflatoxin levels (B_1 , B_2 , G_1 , G_2) and $r = 0.88$ for the fluorescence vs aflatoxin B_1 , B_2 . The results provided a basis for effective determination of BGY-fluorescence as an estimate of aflatoxin levels in corn.

Effects of Handling and Preparation of Turkey Products on the Survival of *Campylobacter jejuni*, G. R. Acuff, C. Vanderzant, M. O. Hanna, J. G. Ehlers and F. A. Gardner, Department of Animal Science and Department of Poultry Science, Texas Agricultural Experiment Station, Texas A&M University, College Station, TX 77843

J. Food Prot. 49:627-631

Various cooking procedures (roasting, braising, stewing and microwave cooking) applied to turkey thighs, and washing procedures for contaminated utensils (knives and cutting boards) and food handlers' hands were evaluated for their effectiveness in removing *Campylobacter jejuni*. Roasting, braising and stewing were effective in destruction of *C. jejuni* on contaminated turkey thighs even when the meat was undercooked, reaching an internal temperature of 55°C. Destruction of *C. jejuni* by microwave cooking was assured more fully if a meat thermometer was used to check the internal temperature of the sample rather than by visual evaluation. Washing of utensils with water and detergent, either by hand or in a dishwasher, removed *C. jejuni* except from wooden cutting boards washed by hand. Minimal hand washing procedures may not assure complete removal of *C. jejuni* from contaminated hands.

Examination of Imported Cheeses for Aflatoxin M₁, Mary W. Trucksess and Samuel W. Page, Division of Chemistry and Physics, Food and Drug Administration, Washington, D.C. 20204

J. Food Prot. 49:632-633

A total of 118 imported cheeses from 13 countries were analyzed for aflatoxin M₁. Six were very hard types that included Parmesan, Romano and Sapsago; 74 were hard types that included Swiss and Cheddar; and 38 were soft or semisoft types, mainly Camembert and cheese spreads. Eight (6.8%) contained aflatoxin M₁ at levels of 0.1 to 1.0 ng/g (limit of determination was 0.05 ng/g).

Microbiological Quality of Canadian Frozen Meat Pies, K. Rayman, K. F. Weiss, G. Riedel and G. Jarvis, Food Directorate and Field Operations Directorate, Health Protection Branch, Health and Welfare Canada, Tunney's Pasture, Ottawa, Ontario, Canada K1A 0L2

J. Food Prot. 49:634-638

One hundred and twenty samples of a variety of frozen meat pies were collected from 20 manufacturers across Canada and analyzed for aerobic colony count, coliforms, *Salmonella*, *Clostridium perfringens*, *Staphylococcus aureus*, and yeasts and molds. *Salmonella* was not isolated from any of the pies and only low numbers of *C. perfringens* and *S. aureus* were found. The highest aerobic colony count, coliforms and yeasts and molds were observed in pies with uncooked pastry. The degree of contamination in these pies was not alarmingly high to warrant establishment of microbiological standards or guidelines for these products.

Restructured Pork From Hot Processed Sow Meat: Effect of Mechanical Tenderization and Liquid Smoke, Joseph C. Cordray, Dale L. Huffman and William R. Jones, Department of Animal and Dairy Sciences, Auburn University, Auburn, Alabama 36849-4201

J. Food Prot. 49:639-642

A 2 × 2 factorial design was used to study the effect of tenderization and liquid smoke on sensory and physical attribution of a fully cooked restructured pork item. The lean and fat mass was removed intact within 30 min postmortem from sow carcasses and assigned to a tenderized or non-tenderized treatment with and without liquid smoke. The four treatment groups were: non-tenderized, no liquid smoke (NTNS); non-tenderized with liquid smoke (NTS); tenderized, no liquid smoke (TNS); and tenderized with liquid smoke (TS). Mechanical tenderization was accomplished 1 h postmortem and the two original portions were subdivided for a 1% acid-neutralized liquid smoke treatment. Total processing time from exsanguination to a fully cooked product was 8 h. There were no differences (P>0.05) among any of the treatments for cohesiveness, juiciness, flavor or connective tissue scores or cooking loss. The TNS treatment had higher (P<0.06) tension values as determined by Instron measurements than the NTNS treatment. There were initially no practical differences between TBA values for fresh-frozen and cooked-frozen restructured pork. However, after 30 d of storage (-23°C), the cooked-frozen product had significantly higher TBA values than fresh-frozen product.

Recovery of *Aeromonas hydrophila* from Oysters Implicated in an Outbreak of Foodborne Illness, Carlos Abeyta, Jr., Charles A. Kaysner, Marleen M. Wekell, John J. Sullivan and Gerard N. Stelma, U.S. Food and Drug Administration, Seafood Products Research Center, 909 First Avenue, Seattle, Washington 98174 and Food Research Laboratory, 1090 Tusculum Avenue, Cincinnati, Ohio 45226

J. Food Prot. 49:643-646

Potentially pathogenic *Aeromonas hydrophila* organism were isolated from oysters frozen at -72°C for 1-1/2 years. The oysters which had been associated with 472 cases of gastroenteritis in Louisiana in November 1982, were examined and found negative for *Salmonella*, pathogenic *Vibrio parahaemolyticus*, and diarrhetic shellfish poison. In 1983, oysters from the same shellfish growing area in Louisiana were implicated in seven cases of gastroenteritis caused by *A. hydrophila*. The oysters collected in 1982 were reexamined and found to contain *A. hydrophila* (MPN 9.3/100 g). Twenty-three of 28 strains identified by the MICRO-IS and API-20E systems were positive for at least one of the tests for virulence which included the suckling mouse test, the adrenal Y-1 mouse cell test, and hemolysin assays. Of five strains tested, all showed activity in the rabbit ileal loop. Although these results do not prove that *A. hydrophila* caused the outbreak in 1982, they suggest that in cases of foodborne illness involving oysters, *A. hydrophila* should be included in the screening tests.

Adenosine Triphosphate Bioluminescent Assay to Enumerate Bacterial Numbers on Fresh Fish, Donn R. Ward, Kathleen A. LaRocco and Debra J. Hopson, Seafood Processing Research Laboratory, Virginia Polytechnic Institute, Hampton, Virginia 23669 and United Technologies, Packard, Downers Grove, Illinois 60515

J. Food Prot. 49:647-650

The microbial quality of fresh fish was determined by using a bacterial ATP bioluminescent assay. Assay procedures included differential filtration followed by enzymatic degradation of somatic ATP. This technique limited interference from non-bacterial ATP sources and thus bacterial ATP was quantitated by using the luciferin-luciferase reaction in an automated luminometer. Good correlation ($r = .96$) was obtained from four species of finfish when microbial counts, determined from ATP analyses, were compared to counts determined by using conventional plate count procedures.

Impact of Bacterial Injury and Repair in Food Microbiology: Its Past, Present and Future, Bibek Ray, Animal Science Department, University of Wyoming, Laramie, Wyoming 82071

J. Food Prot. 49:651-655

Studies done during the past 25 years revealed that microorganisms present in semipreserved foods can be injured by sublethal treatments. The injured cells, irrespective of differences in sublethal treatments, have similarities in their manifestation of injury and their repair. A simple resuscitation step incorporated into currently recommended isolation procedures would enable detection of these cells. In the future, microbial cell injury studies should be directed to include not only effective detection of index and pathogenic bacteria from foods, but also growth inhibition of spoilage microorganisms and preservation of lactic cultures.

Water Relations of Foodborne Bacterial Pathogens - An Updated Review, J. A. Troller, Proctor & Gamble Co., Winton Hill Technical Center, 6071 Center Hill Road, Cincinnati, Ohio 45224

J. Food Prot. 49:656-670

The effects of a_w limitation on growth and metabolic activities of foodborne bacterial pathogens continue to be actively investigated in laboratories throughout the world. Perhaps the most intensive work over the past 10 years has centered on growth of *Clostridium botulinum* in multicomponent systems. This emphasis undoubtedly has been the result of concern about the role played by sodium nitrate in formation of nitrosamines and the possibility of a prohibition of the addition of this preservative to foods. While investigations have continued on *C. botulinum* and more "traditional" foodborne pathogens, a "new" group of pathogens, some of them opportunistic, has emerged. Several of these organisms are covered in this review whereas others are not for the simple reason that the water requirements of these organisms have not as yet been investigated. Particularly surprising is the lack of a_w -related information on *Listeria monocytogenes*, *Aeromonas hydrophila* and colohemorrhagic *Escherichia coli*. In fact, the water requirements of gram-negative bacteria in general and the *Enterobacteriaceae* in particular seem to have been somewhat neglected. Researchers intending to do a_w -related research should consider trends in the American diet and in commercial food processors that supply much of it. For example, no one can deny that consumption of fish and seafood products has increased in the diets of many Americans yet potential pathogens indigenous to

these products have received little investigative work in terms of their water requirements. Scombroid poisoning, a form of histamine poisoning, may be caused by several species of gram-negative bacteria, yet we know nothing of the effect of a_w on these organisms, their heat resistance, combinations with modified atmospheres, pH, preservatives, etc. Similarly, limited application of gamma irradiation for sterilization of spices has been approved by the FDA, however, the effect of a_w in these irradiated systems is largely unknown. Certainly greater thermal resistance at low a_w levels has been reported; however, it is surprising that investigators have not searched for a similar effect with irradiation. Despite these shortcomings, a sizeable body of literature and knowledge of a_w and its effects on microorganisms has emerged. Some of the research has only begun to exploit the hard-won knowledge of how microorganisms adapt to, and cope with, environments of low a_w . Based on extrapolations of these efforts and our greater awareness of these physiological facts, one can only predict even greater advancements during the next decade.



SMITH LABORATORY SERVICE
LTD.

367 Olivewood Road
Toronto, Ontario, Canada
M8Z 2Z8
Tel. (416) 231-2546

Microbiological and chemical analysis of foods and dairy products, filth analysis, plant inspections, process evaluation, sanitation audits, research and development consultation.

Please circle No. 207 on your Readers Service Page

READER SERVICE INFORMATION

International Association of Milk, Food and Environmental Sanitarians, Inc.

To receive
information
on membership
in the International
Association (IAMFES)
Circle 360
on this page.

Use this Reader Service Page to receive
information on products and services in this issue. . .

Please complete all information.
Circle numbers and mail
today _____
Limit 10 inquiries

Name _____

Company Name _____

Title _____

Address _____

City _____ State/Province _____

Zip _____ Country _____

Occupation _____

Phone Number () _____

101	121	141	161	181	201	221	241	261	281	301	321	341
102	122	142	162	182	202	222	242	262	282	302	322	342
103	123	143	163	183	203	223	243	263	283	303	323	343
104	124	144	164	184	204	224	244	264	284	304	324	344
105	125	145	165	185	205	225	245	265	285	305	325	345
106	126	146	166	186	206	226	246	266	286	306	326	346
107	127	147	167	187	207	227	247	267	287	307	327	347
108	128	148	168	188	208	228	248	268	288	308	328	348
109	129	149	169	189	209	229	249	269	289	309	329	349
110	130	150	170	190	210	230	250	270	290	310	330	350
111	131	151	171	191	211	231	251	271	291	311	331	351
112	132	152	172	192	212	232	252	272	292	312	332	352
113	133	153	173	193	213	233	253	273	293	313	333	353
114	134	154	174	194	214	234	254	274	294	314	334	354
115	135	155	175	195	215	235	255	275	295	315	335	355
116	136	156	176	196	216	236	256	276	296	316	336	356
117	137	157	177	197	217	237	257	277	297	317	337	357
118	138	158	178	198	218	238	258	278	298	318	338	358
119	139	159	179	199	219	239	259	279	299	319	339	359
120	140	160	180	200	220	240	260	280	300	320	340	360

Domestic expires 60 days after publication; Foreign 90 days

Reader requests for information are sent to the appropriate company. Follow-up on reader requests are the responsibility of the company advertising.

Tear out, fold, staple and mail - self addressed on opposite side

Place
Stamp
Here

IAMFES, Inc.
Reader Service Information
P.O. Box 701
Ames, IA 50010

Moisture Determinations of Food Stuffs Within Minutes with the AQUASTAR™ System

Volumetric Titrator / Solid Evaporator / Pyridine Free Reagents

■ Save Analytical Time ■ Eliminate Loss on Drying Procedures



The EM SCIENCE AQUASTAR Solid Evaporator, used in conjunction with AQUASTAR Volumetric Titrator, provides fast, easy moisture measurements of food stuffs. Get accurate results within a few minutes.



A Division of EM Industries, Inc.
111 Woodcrest Rd.
Cherry Hill, NJ 08034-0395
(609) 354-9200
(800) 222-0342

Associate of E. Merck, Darmstadt, Germany

✂ For fast response to your inquiry, cut this coupon out and send on your letterhead.

Name _____
Company _____
Address _____
City _____ State _____ Zip _____
Phone () _____

- Yes, I am interested in a demonstration of the AQUASTAR System
- Please send more information on AQUASTAR KF instruments
- Please send more information on Pyridine Free KF Reagents

Filter-Flo SANITARY MANHOLE VENT

Patent No. 3377784

Eliminates Contamination from Dust, Insects and Foreign Matter . . . with Tanker Manhole Completely Open While Unloading.

- Takes only seconds to attach.
- Portable and lightweight (14 lbs.).
- Fits manholes up to 19" in diameter.
- Spun cover protects filter pad against damage and moisture when in use.
- Single unit can be moved from tank to tank without loss of time.
- Provides protection against hazard of internal vacuum while unloading.
- Ideal for plant unloading operations.



Write for free literature and prices



WALKER STAINLESS EQUIPMENT CO.

New Lisbon, Wisconsin 53950 • (608) 562-3151

1986

August 29 - September 2, FOOD PACIFIC '86, CANADA'S INTERNATIONAL TRADE SHOW ON FOOD, to be held at B.C. Place Stadium. For more information contact: FOOD PACIFIC '86, 165-10651 Shellbridge Way, Richmond, B.C. V6X 2W9. 604-276-2277

September 8-9, FOOD PLANT SANITATION WORKSHOP, City of Industry, California. Contact Shirley Grunder at (913) 537-4750 or write: Shirley Grunder, Sanitation Education Department, American Institute of Baking, 1213 Bakers Way, Manhattan, KS 66502.

September 15-17, IFDA ADVANCED FOODSERVICE BUYERS SEMINAR to be held at Tysons Corner Marriott Hotel. For more information contact: Chuck Brimmer, 703-532-9400.

September 16-18, NEW YORK STATE ASSOCIATION OF MILK AND FOOD SANITARIANS ANNUAL CONFERENCE to be held at the Syracuse Sheraton Inn and Convention Center, Liverpool, NY. For more information contact: Paul J. Dersam, Executive Secretary, NYSAMFS, 27 Sullivan Road, Alden, NY 14004.

September 20 - October 3, 1986 XXII INTERNATIONAL DAIRY CONGRESS, The Hague, The Netherlands. For more information contact: H. Wainess, Secretary U.S. National Committee of the IDF (USNAC), 464 Central Avenue, Northfield, IL. 312-446-2402.

September 22-23, FOOD PLANT SANITATION WORKSHOP, Rexdale, Ontario, Canada. Contact Shirley Grunder at (913) 537-4750 or write: Shirley Grunder, American Institute of Baking, 1213 Bakers Way, Manhattan, KS 66502.

September 22-26, 70TH ANNUAL SESSIONS OF THE INTERNATIONAL DAIRY FEDERATION. For more information contact: Congress Organizing Department, c/o Netherlands Congress Centre, P.O. Box 82000, 2508 EA The Hague, The Netherlands. You may also contact: H. Wainess, Secretary U.S. National Committee of the IDF, 464 Central Avenue, Northfield, IL. 312-446-2402.

September 23-25, WYOMING PUBLIC HEALTH SANITARIANS ASSOCIATION ANNUAL MEETING, to be held at the Holiday Inn, Thermopolis, WY 82443. For more information contact: William George, 118 1/2 N. 11th, Worland, WY 982401. 307-347-2617.

September 23-26, FOOD SAFETY TRAINING COURSE to be held at the Holiday Inn-University Center, Gainesville, Florida. For more information contact: Sara Jo Atwell, ABC Research Corporation, 3437 SW 24th Avenue, Gainesville, FL 32607. 904-372-0436.

September 24-25, SEVENTH ANNUAL JOINT EDUCATIONAL CONFERENCE, to be held at the Valley Inn, West Allis, Wisconsin.

For more information contact: Ron Buege, West Allis Health Department, 7120 West National Avenue, West Allis, Wisconsin 53214. 414-476-3770.

September 29-30, SANITATION THRU DESIGN, Manhattan, Kansas. Contact Shirley Grunder at (913) 537-4750 or write: Shirley Grunder, Sanitation Education Department, American Institute of Baking, 1213 Bakers Way, Manhattan, KS 66502.

October 1, OHIO ASSOCIATION OF MILK, FOOD AND ENVIRONMENTAL SANITARIANS SEMI-ANNUAL MEETING, Duff's Smorgasborg, Rt. 161, Columbus, OH. For more information contact: Don Barrett, Columbus Health Department, 6727 Deepwood Ct., Reynoldsburg, OH 43068.

October 5-9, AMERICAN ASSOCIATION OF CEREAL CHEMISTS ANNUAL MEETING, Toronto Hilton Harbour Castle, Toronto, Ontario, Canada. For more information contact: Raymond J. Tarleton, Exec. Vice President, AACC, 3340 Pilot Knob Road, St. Paul, MN 55121.

October 14-17, IN-STORE TRAINING-MANAGEMENT SECTION, Manhattan, Kansas. Contact Donna Mosburg at (913) 537-4750 or write: Donna Mosburg, Registrar, American Institute of Baking, 1213 Bakers Way, Manhattan, KS 66502.

October 20-22, ADVANCED SANITATION PROGRAM, Alexandria, Virginia. Contact Shirley Grunder at (913) 537-4750 or write: Shirley Grunder, Sanitation Education Department, American Institute of Baking, 1213 Bakers Way, Manhattan, KS 66502.

October 21-22, CALIFORNIA ASSOCIATION OF DAIRY AND MILK SANITARIANS ANNUAL MEETING, to be held at Holiday Inn Downtown, Fresno, CA. For more information contact: Richard C. Harrell, 1554 West 120th St., Los Angeles, CA 90047. 213-757-9719.

October 27-29, DISTRIBUTION INFORMATION SYSTEMS, Manhattan, Kansas. Contact Donna Mosburg at (913) 537-4750 or write: Donna Mosburg, Registrar, American Institute of Baking, 1213 Bakers Way, Manhattan, KS 66502.

October 27-29, 1986 INTERNATIONAL WHEY CONFERENCE, sponsored jointly by the Whey Institute and the International Dairy Federation, O'Hare Marriott Hotel, Chicago, IL. For more information contact: Conference Secretariat, Whey Products Institute, 130 North Franklin Street, Chicago, IL 312-782-5455.

November 1-6, FOOD SANITATION 29TH ANNUAL NATIONAL EDUCATIONAL CONFERENCE & EXPOSITION, Scottsdale, Arizona. For more information contact: Harold Rowe at 813-586-5710 or write: Jean Day, Registrar, Food Sanitation Institute, 1019 Highland Ave., Largo, FL 33540.

November 2-6, SANITATION MANAGEMENT CONFERENCE AND EXPOSITION, to be held at the Safari Conference Center Re-

sort, Scottsdale, Arizona. For more information contact: Environmental Management Association's national executive office at 1019 Highland Ave., Largo, FL 33540. 813-586-5710.

November 6, FOOD MICROBIOLOGY UPDATE, Inn at the Park, Anaheim, CA. For more information contact Kathryn J. Boor, Food Science and Technology, University of California, Davis, CA 95616. (916) 752-1478.

1987

February 5-7, FOOD ADDITIVES, THE CHANGING CLIMATE? 1ST INTERNATIONAL CONGRESS, to be held at the Hilton Hotel, Vienna, Austria. For more information contact: Secretariat of the Food Additives, The Changing Climate, 1st International Congress, 30 Deane Way, Ruislip, Middlesex HA4 8SX, England.

March 31 - April 1, WESTERN FOOD INDUSTRY CONFERENCE, to be held at the University of California, Davis, CA. For more information contact: Robert Pearl, Conference Chairman, 916-752-0980 or Shirley Rexroat, Conference Coordinator, Department of Food Science and Technology, University of California, Davis, CA 95616.

AUGUST 2-6, IAMFES ANNUAL MEETING to be held at the Disneyland Hotel, Anaheim, CA. For more information contact: Kathy R. Hathaway, IAMFES, Inc., P.O. Box 701, Ames, IA 50010. 515-232-6699

September 26-30, DFISA's FOOD & DAIRY EXPO '87, to be held at McCormick Place, Chicago, IL. For more information contact: DFISA, 6245 Executive Boulevard, Rockville, MA 20852. 301-984-1444.

November 1-5, AMERICAN ASSOCIATION OF CEREAL CHEMISTS ANNUAL MEETING to be held at the Opryland Hotel, Nashville, TN. For more information contact: Raymond J. Tarleton, Exec. Vice President, AACC, 3340 Pilot Knob Road, St. Paul, MN 55121.



**PRESSURE
MEASUREMENT
SOLUTIONS**

New Sanitary Pressure Transmitter with easily cleaned flush diaphragm minimizes bacterial buildup

Problem:

How to monitor system pressure or flow in processes requiring sanitary operating conditions such as pharmaceuticals, food and beverage.

Solution:

Viatran developed an all stainless steel, completely sealed, flush diaphragm transmitter that can be cleaned with steam or chemicals while in-place. The unit also may be removed easily for cleaning.

Product:

**MODEL "50" SERIES SANITARY PRESSURE
MINIATURE TRANSMITTER**

External zero and span adjustment available in the Sanitary series—optional.

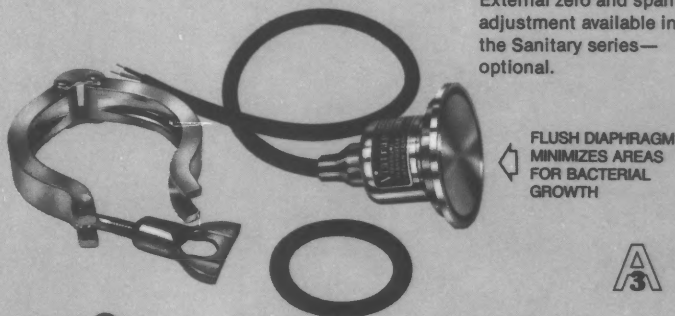

FLUSH DIAPHRAGM
MINIMIZES AREAS
FOR BACTERIAL
GROWTH



Viatran

Call our Sales Engineering HOTLINE . . . 716-773-1700

CORPORATION

300 INDUSTRIAL DRIVE • GRAND ISLAND, NY 14072 • TWX: 710-260-1353



JOIN THE CULTURE REVOLUTION. USE BBL® DEHYDRATED CULTURE MEDIA.

Get in step with one company that leads the parade when it comes to bacterial culture media products. **BBL** is out front in so many ways.

Quality Control

We're marching on the competition by offering to provide, upon request, a **BBL** Quality Control Certificate. It's your assurance of strict uniformity within lots as well as consistency from lot to lot.

Customer Service

The **BBL** ranks include a nationwide network of distributors who will break into double time if that's what it takes to process and deliver your order without delay.

Special Formulations

Not everyone marches to the same drummer, which is why **BBL** stands ready to customize formulations to suit your individual needs. Just give us a call at (800) 638-8663.

Product Variety

The **BBL** banner provides a wide range of dehydrated media formulations for industrial testing: cosmetics, pharmaceuticals, food, beverage, dairy, water/wastewater.

Don't let the parade pass you by. Join the BBL Culture Revolution.

BBL Microbiology Systems

**BECTON
DICKINSON**

