

June, 1983
Vol. 3, No. 6
Pages 201-240
ISSN:0273-2866
Box 701
Ames, Iowa 50010

\$5.00

UNIVERSITY MICROFILMS
INTERNATIONAL
300 NORTH ZEEB ROAD
ANN ARBOR MI
48106

Dairy and Food Sanitation

A Publication for Sanitarians and Fieldmen

- Antibiotic Formulations For Drying Off Therapy of Dairy Cattle
- Two Years of Mandatory Foodborne Illness Prevention Certification Training in Moorhead, Minnesota
- Training: Creative Ways to Make it Work for You!

70th Annual Meeting
Marriott Pavilion
St. Louis, MO
August 7-11, 1983



*A Publication of the International
Association of Milk, Food and
Environmental Sanitarians, Inc.*

Ralston Purina Farm Dinner and Entertainment Featured at the 70th IAMFES Annual Meeting in St. Louis, MO



Checkerboard Square located in St. Louis, Missouri is the international headquarters of Ralston Purina Company. The company also maintains an experimental agricultural farm located outside the City of St. Louis. Through the company's hospitality, registrants at the 70th International Association of Milk, Food and Environmental Sanitarians Meeting will have the opportunity to visit the farm, take a short bus tour of the farm with brief stops at the experimental dairy farm and other appropriate locations. This will be followed by a family style country fried chicken dinner and variety show entertainment. Don't miss this one! August 7-11, 1983. Registration form included in this issue.

IAMFES

WANTS YOU

AS A MEMBER FOR 1983

Receive both outstanding journals each month
PLUS benefits of membership

This is YOUR professional organization . . .

1. PLEASE CHECK ONE
2. Mail TODAY . . . don't miss a single issue

Yes, I want to be a member and support my profession, as well as to continue to educate myself monthly with the journals

PLEASE ✓ ONE
BEST BUY

- Journal of Food Protection* (12 issues)
Dairy and Food Sanitation (12 issues) BOTH JUST \$50
- Dairy and Food Sanitation* (12 issues) \$28
- Journal of Food Protection* (12 issues) \$40

YOUR NAME _____

CO. NAME _____

ADDRESS _____

CITY _____ STATE _____ PROVINCE _____ ZIP _____

Check one:

- Payment Enclosed
 Please Bill Me
 Charge to MasterCard or Visa
(circle appropriate card)

Card # _____

Expiration Date _____

FOREIGN:

Add \$7 for each Journal ordered for postage

MAIL TO:

IAMFES
413 Kellogg
Ames, IA 50010

clip & mail today

IAMFES Sustaining Members

Alpha Chemical Services, Inc.
P.O. Box 431
Stoughton, MA 02072

Anderson Chemical Co.
Box 1041
Litchfield, MN 55355

Angenics, Inc.
100 Inman St.
Cambridge, MA 02139

Associated Milk Producers, Inc.
830 N. Meacham Rd.
Schaumburg, IL 60195

Babson Bros. Co.
2100 S. York Road
Oak Brook, Illinois 60521

Borden, Inc.
Dairy & Services Div.
16855 Northchase
Houston, TX 77060

C.I.S.I.
Via Massarenti 54
40138 Bologna, Italy

Dairymen, Inc.
10140 Linn Station Road
Louisville, KY 40223

Darigold
635 Elliott Ave. W.
Seattle, WA 98109

Dean Foods
1126 Kilburn Ave.
Rockford, IL 61101

De Laval Agricultural Division
Alfa-Laval Inc.
11100 North Congress Avenue
Kansas City, MO 64153

Difco Laboratories
P.O. Box 1058-A
Detroit, MI 48232

Eastern Crown, Inc.
P.O. Box 216
Vernon, N.Y. 13476

GAF
140 West 51st St.
New York, NY 10020

G. B. Fermentation, Inc.
PO Box 241068
Charlotte, NC 28224

Gerber Products Co.
445 State St.
Fremont, MI 49412

H. B. Fuller Co.
Monarch Chemicals Div.
390 Jackson St. NE
Minneapolis, MN 55421

Kendall Co.
One Federal St.
Boston, Massachusetts 02101

Klenszade Division
Economics Laboratory, Inc.
Osborn Building
St. Paul, MN 55102

The Kroger Co.
1212 State Avenue
Cincinnati, OH 45204

Maryland & Virginia Milk Producers Assn., Inc.
P.O. Box 9154 Rosslyn Station
Arlington, Virginia 22209

Michigan Milk Producers Assoc.
24270 W. Seven Mile Road
Detroit, MI 48219

Mid America Dairymen, Inc.
P.O. Box 1837 SSS
800 W. Tampa
Springfield, MO 65805

M. M. Muzzarelli Modens s.r.l.
via Galileo Galilei, 162
41100 Modena, Italy

Nasco International
901 Janesville Ave.
Fort Atkinson, Wisconsin 53538

National Mastitis Council
1840 Wilson Blvd.
Arlington, VA 22201

National Milk Producers Federation
30 F St. NW
Washington, DC 20001

Norton Co.
P.O. Box 350
Akron, Ohio 44309

Oxold USA, Inc.
9017 Red Branch Rd.
Columbia, MD 21045

Reitman Manufacturing Co.
10319 Pearmain St.
Oakland, CA 94603

Roslita, Inc.
P.O. Box 685
Wood Dale, IL 60191

Selberling Associates, Inc.
11415 Main St.
Roscoe, Illinois 61073

United Industries, Inc.
1546 Henry Avenue
Beloit, WI 53511

Universal Milking Machine Div.
Universal Cooperatives Inc.
408 S. First Ave.
Albert Lea, MN 56007

W. A. Golomski & Associates
1006 Martin Dr. West
Bellevue, NE 68005

Walker Stainless Equipment Co.
601 State St.
New Lisbon, WI 53950

Webco Chemical Corporation
Rt. 197
Dudley, Massachusetts 01570

Zero Manufacturing Co.
811 Duncan Ave.
Washington, MO 63090

Dairy and Food Sanitation is published monthly by the International Association of Milk, Food and Environmental Sanitarians, Inc, executive offices at PO Box 701, 413 Kallogg, Ames, IA 50010. Printed by Heuss Printing, Inc, 911 Second St, Ames, IA 50010. Second-class postage paid at Ames, IA. Postmaster: Send address changes to IAMFES, 413 Kallogg, Ames, IA 50010-0701.

Manuscripts: Correspondence regarding manuscripts and other reading material should be addressed to Kathy Hathaway, PO Box 701, Ames, IA 50010-0701. 515-232-6699.

"Instructions to Contributors" can be obtained from the editor.

Orders for Reprints: All orders should be sent to

IAMFES, Inc., PO Box 701, Ames, IA 50010-0701. Note: Single copies of reprints are not available from this address; address reprint requests to principal author.

Business Matters: Correspondence regarding business matters should be addressed to Earl O. Wright, IAMFES, PO Box 701, Ames, IA 50010-0701.

Subscription Rates: \$60.00 per volume, one volume per year, January through December. Single copies \$5.00 each.

Sustaining Membership: A sustaining membership in IAMFES is available to companies at a rate of \$300 per year, which includes \$100 credit toward an ad in the "annual meeting issue" of the Journal, usually the July issue. For more information, contact IAMFES, PO Box 701, Ames, IA 50010-

0701, 515-232-6699.

Membership Dues: Membership in the Association is available to individuals only. Direct dues are \$28.00 per year and include a subscription to *Dairy and Food Sanitation*. Direct dues and both journals are \$50.00. Affiliate membership is \$28.00 per year, plus state dues, and include a subscription, also. Affiliate dues and both journals are \$50.00, plus state dues. Student membership is \$10.00 per year, with verification of student status, and includes one journal.

Claims: Notice of failure to receive copies must be reported within 30 days domestic, 90 days foreign. All correspondence regarding changes of address and dues must be sent to IAMFES, Inc., P.O. Box 701, Ames, IA 50010-0701, 515-232-6699.

IAMFES
OFFICERS AND EXECUTIVE BOARD

President, ROBERT MARSHALL, 203 Eckles Hall, Univ. of Missouri, Columbia, MO 65201.

President-Elect, A. RICHARD BRAZIS, W. A. Golonski & Assoc., Manager, Sanitation-Microbiology Group, 1006 Martin Drive West, Bellevue, NE 68005.

First Vice-President, ARCHIE C. HOLLIDAY, VA Dept. of Ag., 1100 Bank St., Suite 600, Richmond, VA 23219.

Second Vice-President, SIDNEY BARNARD, 9 Borland Lab, Pennsylvania State University, University Park, PA 16802.

Secretary-Treasurer, ROY GINN, Dairy Quality Control Inst., 2353 No. Rice St., Room 110, St. Paul, MN 55113.

Jr. Past President, HARRY HAVERLAND, FDA Training Facility, Room 8002, Federal Office Building, 550 Main St., Cincinnati, OH 45202.

Sr. Past President, WILLIAM ARLEDGE, Dairymen, Inc., 10140 Linn Station Road, Louisville, KY 40223.

Affiliate Council Chrmn., LEON TOWNSEND, Milk Control Branch, Bureau for Health Services, 275 East Main St., Frankfurt, KY 40601.

EDITORS

KATHY MOORE HATHAWAY, *Editor*,
Box 701, Ames, Iowa 50010

EARL O. WRIGHT, *Executive Secretary
and Managing Editor*, Box 701, Ames,
Iowa 50010

EDITORIAL BOARD

H. V. ATHERTON	Burlington, VT
K. J. BAKER	Rockville, MD
D. K. BANDLER	Ithaca, NY
S. BARNARD	University Park, PA
H. BENGSCHE	Springfield, MO
F. BODYFELT	Corvallis, OR
J. BRUHN	Davis, CA
J. BURKETT	Sioux City, IA
J. CARROLL	Arlington, TX
J. CHAMBERS	West Lafayette, IN
C. D. CLINGMAN	Orlando, FL
R. DICKIE	Madison, WI
F. FELDSTEIN	Culpeper, VA
R. FUQUA	Mt. Juliet, TN
E. GADD	Jefferson City, MO
J. GERBERICH	Eau Claire, WI
P. HARTMAN	Ames, IA
C. HINZ	Alexander, NY
C. JELLINGS	Clinton, IA
J. JEZESKI	Gainesville, FL
W. LAGRANGE	Ames, IA
C. LIVAK	Lancaster, PA
P. MARTIN	Chicago, IL
D. MILLER	Orlando, FL
L. PARHAM	Oklahoma City, OK
C. PRICE	Lombard, IL
D. RACE	Camillus, NY
J. REEDER	Arlington, VA
D. ROLLINS	Springfield, MO
R. SANDERS	Washington, DC
G. SMITH	Schenectady, NY
C. WEBSTER	LaClaire, IA
E. ZOTTOLA	St. Paul, MN

Dairy and Food Sanitation

Vol. 3

June, 1983

No. 6

- **Training: Creative Ways to Make It Work for You!** 204
Dr. Robert B. Gravani
- **Two Years of Mandatory Foodborne Illness Prevention Certification Training in Moorhead, Minnesota** 208
Gail Hennum, D. Lawrence and O. P. Snyder, Jr.
- **Antibiotic Formulations for Drying Off Therapy of Dairy Cattle** 215
W. Donald Schultze

News & Events	220
National Mastitis Council Program	222
3-A Sanitary Standards Amendments	223
Affiliate News	230
Calendar of Events	231
Instruction for Authors Guide	232
Annual Meeting Registration Form	234
JFP Abstracts	237

Training: Creative Ways to Make it Work for You!

DR. ROBERT B. GRAVANI

*Institute of Food Science
 Stocking Hall
 Cornell University
 Ithaca, NY 14853*

Training and continuing education programs, seminars and lectures are all part of our daily quest for knowledge. With the increase in the number of these programs it is important that practical, meaningful and worthwhile sessions be planned. If properly organized and implemented, cooperative programs that involve the food industry, regulatory agencies and the academic community can achieve success beyond all expectations. Training programs such as those listed below can maximize time, manpower and operating budgets.

*Industry Training Sessions
 Self Inspection Programs
 Employee Certification
 Total Quality Control/Assurance Program
 Consumer Hot Lines
 Merit Awards
 Newsletters
 Frequent Violators Training Programs*

Innovative teaching techniques utilizing slides, video tapes, interactive video, management games and situational problems are all ways to make these programs practical and very informative.

Everywhere we turn today, we see or hear news concerning our difficult economic times. Television, newspapers and magazines all abound with information relating to problems caused by the economy. What are the current concerns in the food industry, regulatory agencies and universities? (5)

Regulatory Concerns

- Budget Cuts
- Manpower Reductions
- Reduced Frequency of Inspections
- Decreased Travel Funds
- Poor Employee Morale

Dr. Gravani is Assistant Professor of Food Science at Cornell University. He works with the New York State food industry in the area of microbiology, sanitation and regulations. He is actively involved in planning, organizing and implementing training programs for the food industry and regulatory agencies.

Industry Concerns

- Budget Cuts
- Maintaining Revenues
- Retaining Market Share
- Profitability
- Complying With Regulations

Academic Concerns

- Budget Cuts
- Decreased Travel Funds
- Decrease in Extension Programs
- Poor Employee Morale

When times are tough and budgets are tight, innovation and serious thinking are needed to discover solutions to problems -- people must brainstorm, explore, become creative, innovative and develop solutions to the problems at hand. The old adage "When life gives you lemons, make lemonade" comes to mind. How can these problems be solved? Through creative training programs -- not merely traditional programs, but innovative, provocative and practical programs. Cooperative educational programs utilizing the skills and expertise of industry, regulatory and academic personnel can be used to stimulate interest and solve some problems. These types of programs provide a synergistic effect -- a cooperative action with a total effect greater than the sum of the effects taken separately -- in other words, by working together, the end result will probably be much more effective than either group working alone. A well planned, organized and executed program with proper follow-up will pay dividends beyond expectation.

A variety of possible training programs exist and have been implemented in New York State. They will be discussed below.

Training Program Ideas

Several types of training programs are possible. (5)

They include:

Co-sponsored Industry, Regulatory and Academic (IRA) Training -- programs on a variety of topics such

as food processing, GMP's warehouse sanitation, packaging, labelling, imports, recalls, etc. The list is endless. The New York District of FDA, New York State Department of Agriculture and Markets, the New York Import District of FDA, the New York State food industry and the Institute of Food Science at Cornell University all have participated in co-sponsored training programs with great success. Input, suggestions and active participation by all these groups are required to achieve success. Programs of this type can be done on a "break even" basis with a small fee charged to participants to cover costs of room rental, audio visual aids, lunch and other incidental items.

Frequent Violators Training -- By working with industry and academia, state regulatory agencies have put together well organized formal presentations for frequent violations. These presentations have focused on the reasons why violative conditions in an establishment are not permitted. A practical and workable explanation of the inspection violations are provided during this session. The Food Inspectors Service division of the New York State Department of Agriculture and Markets is currently using an excellent slide set for this type of training program.

Total Quality Assurance Training -- The Hazard Analysis and Critical Control Points (HACCP) concept applied to companies' production and warehousing facilities is an excellent way to begin an employee training program. The items mentioned in the GMP's can be made meaningful to supervisors, foremen, and all employees. The Japanese concept of quality circles can very easily be incorporated into this type of program to stress the importance of producing quality food products.

Employee Certification Programs -- This type of program is already popular in the food service industry and is used with key employees in the low-acid canned food industry. It can be applied to a whole variety of individuals in regulatory agencies and the food processing industry.

Fact Sheets/Newsletters and Printed Materials (Booklets, Pamphlets, Flyers, etc.) -- Relevant and accurate information on food safety, food processing and food service produced by universities, regulatory agencies, trade associations and foundations should be disseminated to the people who can apply these principles to their daily responsibilities. This training concept can also be applied to consumers by providing facts that will enable them to understand the complexity of the food industry and current issues concerning foods.

There are only a few examples of programs and projects that have been successfully implemented (5).

With proper planning, creativity and an eye for details, successful training programs can be accomplished. Creative training programs don't just happen; a great deal of hard work including proper planning and an eye for details must occur before a program is successful (4). The discussion below will focus on several critical aspects of creative program development that include the method of instruction as well as the types and selection of audio visual aids.

Creative Training

Audiences in the '80's are different than ones in past years. They are smarter, more sophisticated; they've grown up with television; they are less tolerant with ill-prepared speakers and poor presentations -- they want RELEVANT information delivered effectively when they need it.

Training programs need to be creative to achieve the desired results, that is to change peoples' attitude or behavior. If behavior was not altered, then either the training program was unnecessary or it was a failure!

Gravani (4) summarized the basic principles involved in planning, organizing, staffing, controlling, evaluating and following up training programs. Some of the critical points that should be considered include:

- Adequate and proper planning of the entire program with attention to details.
- Choosing the best and most effective teachers and communicators (the most knowledgeable person may not always be the best speaker -- sometimes a tradeoff must be made in this area).
- Educational level and experience of audience.
- Method(s) of instruction.
- Selection and use of visual aids.

Selecting the proper method of instruction and highlighting it with good visual aids can enliven dull subjects, motivate participants, spark enthusiasm and leave the audience with a very positive feeling about the material being presented. When choosing a method of instruction, most people choose the best known form of group communication -- the lecture. It is convenient and easy, with a speaker simply telling the group about principles involved. There are some problems, however -- no matter how dynamic a speaker is, it is very difficult to keep people's attention for 45-60 minutes (or longer) without the use of visuals. This is especially true with non-professional audiences. Most people are capable of listening at a rate of about 500 words per minute, while the average speaker talks at about 125 words per minute. A simple mathematical calculation reveals that most people have a 375 word per minute capability that they are not using (6). This process of talking and listening leaves people in the audience with 75% of their "mental time" free to either absorb the message or pursue other activities. A speaker must motivate an audience or they will use this "free time" to daydream and forget what is being said.

Communication experts estimate that people learn by using all their senses (1).

Touch, taste and smell --	6%
Hearing --	11%
Seeing --	83%
People retain: 10% of what we read	
20% of what we hear	
30% of what we see	
50% of what we see and hear	
90% of what we learn by doing	

These figures are impressive and certainly make a strong case for taking time to select the proper method of instruction, to prepare good quality visuals and to get the audience involved in the training program (4).

Method of Instruction

Lectures, demonstrations, "hands on" programs and audience participation programs such as role playing activities, case studies, scenarios, problem solving sessions, instructional games and simulations are all examples of instructional methods. Video tape and video disk programs can be used to supplement these methods of instruction or can often be used as a method of instruction by themselves. This depends on the type, quality and length of the tape or disk. Handout materials can be distributed to the audience to supplement or highlight important principles presented during the program.

Visual Aids

Since a picture is worth ten thousand words, audiences will have a much better chance of learning and retaining the concepts in a training program that is supplemented or highlighted with visual aids (8). Many training programs and presentations have been ruined and their impact totally lost because visuals were not used, or were poorly used.

The following visual aids can be used to enhance any kind of training program (9):

- The "real thing" - actual objects
- Models and miniatures
- Posters and signs
- Diagrams, charts, graphs, maps and handout materials
- Drawings/cartoons
- Chalkboards, flannelboards and magnetic boards
- Photographs and pictures
- Slides, filmstrips, overhead transparencies
- Opaque projections
- Movies
- Video tape and video disk

When preparing visual aids for use with a presentation, some important items must be considered (9). The visual aid must be appropriate, timely and not disruptive; it must be **LARGE ENOUGH** to be seen by all in the audience. The more simple the visual, the more effective it will be. A visual aid should be displayed or used only when it is being discussed. If any visual technique is over-used in a presentation or program, it will lose its impact.

As a last item of advice -- prepare the aid and practice using it in advance. Be ready for any possible problem to occur. Think of all the times that you were in the audience when a speaker had problems with visual aids (i.e. - bulbs burning out, slides containing too much information, no extension cords, etc.).

An important question that every trainer should ask is "when should I use this visual aid?". Each aid has a specific situation where it should be used; many times the wrong visual aids are selected and consequently impede, rather than enhance the retention of the material being taught.

The correct use of visual aids is given below (9):

The Real Thing -- use when:

- Realism is needed or when you want to involve as many of the five senses as possible.
- They are practical from standpoint of size, transportation and maintenance.
- The object is unusual or interesting enough to attract or maintain attention for your message.

Models and Miniatures -- use when:

- Something very big or very small must be shown as realistically as possible.
- Inside or cutaway views help tell your story.

Verbal Visuals, as Posters and Signs -- use when:

- Presenting ideas that cannot be visualized.
- Emphasizing slogans or words that need to be remembered.
- The message involves a few major points.

Diagrams, Charts, Maps & Handout Materials -- use when:

- You must tell about an object or situation and realism is not needed.
- You need to communicate details (i.e., changes over time, trends, percentages, etc.).

Drawings/Cartoons -- use when:

- Abstraction or leaving out of detail emphasizes that which is shown. You eliminate all but the essential.
- Photos and real things are not available.
- A method or feeling cannot be achieved or described by other means.

Chalkboards, Flannelboards, Magnetic Boards -- use when:

- You want to "show how", or "build on", as to present your story gradually, but have it remain in view as you continue.
- You can use them as more than a means of presenting words.

Photographs and Pictures -- use when:

- You cannot show an actual object or the real thing.
- You want to show something larger than life-size, or for clearer detail.
- You compare situations - past and present - good and bad, or conditions somewhere else.
- You want to visualize over time, or step by step processes.
- You cannot show ideas or moods (pain, grief, sorrow) by any other means.

Slides, Filmstrips, Overhead Transparencies or Opaque Projection --use when:

- You need the advantages of photographs or pictures, plus color and enlargement by projection on a screen.
- You expect to make multiple use, or duplicates.
- You want to standardize presentation.
- You can utilize special features of the various projection equipment.

Movies -- use when:

- Your story will be enhanced by the content and sound (action and mood)
- You want to determine emphasis and exact content in advance and want to standardize presentation.
- You need the advantages of photographs and projected visuals.
- You properly introduce the film -- prepare the audience so it will learn the most -- and follow the film with discussion or question and answer period.

Video tape is a "new" technology that is now coming into its own as a medium to teach and train (7). The capabilities of video tape are limitless. Role playing, situational training, inspection techniques, laboratory experiments, processing procedures, food service sanitation and many other principles and situations can be well depicted using video (5). The nature of the materials being taught will certainly influence the method of instruction used; not all subjects require the sophistication of video, however, when done properly, video can make dry, uninteresting subjects come alive.

Video tape is basically a one way form of communication. The audience views a situation and silently reacts to it; the audience cannot respond specifically to the video tape. If an instructor or trainer is involved in the program, the audience response to the tape can be solicited after

viewing. Recent technological advances have connected computers to video tape players to provide two-way communication (2,3). A hand held "calculator like" device allows the participant to respond directly to questions asked in the video tape program. The computer uses the answers to bring the trainee to the next level of instruction. This new technology is called interactive video and it is currently being researched, tested and utilized by major corporations, the military and universities as one of the training techniques of the future (2,3).

Creative training programs just don't happen. A great deal of careful planning goes into every aspect of the program. With attention to details and the use of good speakers, relevant material highlighted with visual aids and handouts, audience involvement and follow up, successful training programs can occur!

REFERENCES

1. Auger, B. Y. 1964. *How to Run Effective Business Meetings*. Grosset and Dunlap, New York, NY. 157 pp.
2. Bohne, H. F. 1981. *Interactive Video - It Takes Skills You Already Have*. *Educational and Industrial Television*. 13(10):73-77.
3. Broderick, R. 1982. *Interactive Video: Why Trainers Are Tuning In*. *Training* 19(11):46-49, 53.
4. Gravani, R. B. 1982. *Training Programs: They Need Not Be Boring*, *Dairy and Food Sanitation*. 2:96-99.
5. Gravani, R. B. 1982. *New Weapons for Old Problems*. Presented at the 66 Annual CASA Conference, Harrisburg, PA.
6. Martin, R. D. 1973. *Are You Listening? Oral Communication Aide*. Dept. of Communication Arts, Cornell University. 6 pp.
7. Pachuta, J. J. 1978. *A Program Development Method for Industrial Television*. *Educational and Industrial Television*. 10(11):33-34, 67-69.
8. Smith, H. R. and T. S. Nagel. 1972. *Instructional Media in the Learning Process*. C. E. Merrill Publishing Co., Columbus, OH. 120 pp.
9. Stephen, V. R. 1983. *Tips on Selecting Visuals*. *Visual Communication Aide*. Dept. of Communication Arts, Cornell University. 6 pp.

TWO YEARS OF MANDATORY FOODBORNE ILLNESS PREVENTION CERTIFICATION TRAINING IN MOORHEAD, MINNESOTA

GAIL HENNUM, D. LAWRENCE and O. P. SNYDER,
JR.*

*Department of Food Science & Nutrition
1334 Eckles Ave.
University of Minnesota
St. Paul, MN 55108*

A mandatory foodborne illness prevention program was initiated in Moorhead, Minnesota, in 1978. The program used the 16-hour operator/manager foodborne illness prevention course of the University of Minnesota Foodservice Quality Assurance Program. Some improvements in operations during the two year period include: increased use of thermometers to measure food temperatures; faster and more efficient means of food cooling; the use of the refrigerator for thawing; and organization of cooked foods above raw foods in coolers.

The effectiveness of the program in a restaurant was found to depend on the degree to which the course-required policies, procedures and standards manual was enacted and followed in the unit.

Introduction

In 1978 the City of Moorhead, Minnesota, passed an ordinance requiring mandatory certification of foodservice operators/managers. This was done in response to the FDA's recommendation for a training course to improve food protection practices in foodservice establishments (Food and Drug Administration, 1976; Davis, 1977).

The 16-hour University of Minnesota operator/manager foodborne illness prevention (FIP) course, a part of the Foodservice Quality Assurance Program (FQAP), was used and taught by the local state sanitarian (Snyder, 1975). In the two years since certification became mandatory, there has not been a confirmed foodborne illness connected to a Moorhead foodservice establishment. The purpose of this study was to determine some of the management factors responsible for the absence of complaints.

Background

The program for the prevention of foodborne illness was initiated in 1974 and offered through the Agricultural Extension Service and the Department of Food Science and

Nutrition. The goal of the program is the elimination of foodborne illness by the foodservice industry, improvement of food quality, and improved economic stability and prosperity for the foodservice industry in the state of Minnesota (Snyder, 1979). To meet this goal, the following objectives have been established:

- Top management will be educated in the technology and management of foodborne illness prevention and will have established policies, procedures and standards that, when followed, assure a very low probability of an operational error being made that permits a foodborne illness to occur.
- Top management will have a long-range error prevention plan and provide the resources necessary for FIP.
- Top management will reward and reinforce unit managers' success in FIP performance.
- Unit management will be trained in FIP and hazard and critical control point analysis. With the help of the employee, they will establish or modify operating procedures to fit the unique characteristics of the individual operation.
- Managers will educate the employees to be able to follow the operating policies, procedures and standards and will reinforce their constant adherence through meetings and on-the-job coaching.
- Food handling policies specifying times and temperatures will be posted and updated.
- Critical control points will be recognized and controlled operating procedures established in all operational areas such as purchasing, receiving, storage, preparation, serving and handling of leftovers.
- Employees will carry out the policies established by management; therefore, employee training and reinforcement by the manager will be an ongoing process.
- Facilities will be cleaned and well maintained to ensure sanitation. This includes handwashing areas and bathrooms.

Moorhead, Minnesota's sanitarian recognized the need for educating the operator/manager in FIP because over the years there had been repeated violations of regulations set by the city and the state. The operator/manager FIP course offered through the University of Minnesota's FQAP was recommended for voluntary education. Because there was little voluntary response by industry, a mandatory program

was instituted. The sanitarian contacted the city government for assistance in developing a suitable ordinance. The operators/managers were contacted about the mandatory certification.

An ordinance was written stating that:

All persons, firms, or corporations that operate a food establishment in the City subject to Minnesota Statutes Chapter 157 and this Ordinance, or as may be required by the Health Authority or the City, shall maintain in employment at least one full-time equivalent owner, manager, or operator who is certified as having completed all requirements of a foodservice training and certification program equivalent to the University of Minnesota, Department of Food Science and Nutrition and Agricultural Extension Service course known as "Minnesota Quality Assurance Program for the Prevention of Foodborne Illness Transmission in Foodservice." The licensee shall be responsible for the costs incurred for compliance with this Section. The certified individual need not be on the business premises at all times that the business is open to the public.

This ordinance was then submitted to the local government for approval. The operators/managers were informed of the hearings before the city council and also supplied with a copy of the ordinance. This allowed time for any recommendations. Because of the involvement of the industry in the establishment of the ordinance, only 1 of 43 establishments had any negative input.

Implementation

In April, 1977, the ordinance was passed and completion of certification was set for June, 1978. Classes were scheduled for June and November, 1977. A total of 43 people took the class at this time.

Although the first class was attended by a majority of operators/managers, some persons were reluctant to attend. The sanitarian sent letters to those who did not attend, reminding them of the ordinance and of their responsibility to be certified. All operations were certified before the June 1, 1978, deadline. The following are some problems that occurred and the solutions used to correct them:

1. Procrastination by the operator/manager in completing the FIP policy manual and too much time allowed for completion of certification. Solution: Participants were required to complete the FIP manual on the final day of the class to reduce procrastination.
2. Rapid manager turnover and the operation not informing the city when there was a management change. Solution: Quarterly communications were established with foodservice operations to correlate license holders with certified management.
3. The concern of semi-foodservice operations such as meat markets, grocery stores and bakeries over having to attend a program for full-menu foodservice control when they operated very limited food preparation operations. Solution: A change was made to a two-class license system based on the amount of

food preparation, the semi-foodservice operations were excluded.

4. The increase in the fee for the program which deterred some managers from sending more persons than absolutely required. Solution: To help keep costs down, no increase in license fees was made.

Methods for the Study

The sanitarian chose 16 restaurants to be evaluated at random. He told them to expect an evaluator who would arrange an interview. The interviews took place at the individual foodservice establishments 1-3 days after the initial telephone contact. The certified operator/manager was interviewed on a one-to-one basis. Interviews ranged from 45-90 minutes, depending on the type of operation and the extent to which the program had been implemented.

The form shown in Fig. 1 was used to evaluate the cause and effect relationships governing the degree of implementation of FIP in the foodservice operations. This evaluation form served as a guideline to questioning and as a data-collection tool. Each major section contained specific objectives to be scored.

Scores on a scale of 0-5 (5 being the highest) were given to individual inspection points. These scores were based on answers from the interviewees and on personal observations of the evaluator. Each section score was totalled and averaged to arrive at an overall score that was correlated with the sanitarian's inspection score. The sanitarian's score was compiled from an average of at least two previous sanitation inspections done using the form shown in Figure 2.

All interview participants were asked specific questions involving different areas of emphasis of the FIP program. First, the policy manual was requested and reviewed to determine the manager's commitment to FIP and to evaluate completion. Also, it was used to determine whether policies were being used and enforced. Second, the operator/manager was questioned about food-handling procedures to determine whether he or she remembered at what temperature microorganisms grow and whether they were using this knowledge in the evaluation and control of their food-handling processes. Verification was made of food being cooled in less than 4 hours as required by the FDA Recommended Ordinance and Code. Sanitizing solutions and procedures were checked to determine whether operators/managers undertook solutions and proper concentrations. Third, employee understanding of FIP was evaluated through personal interviews to learn whether management was implementing training and controlling policies, standards and procedures, and to observe evidence of personal commitment to FIP by the employees. Fourth, facilities and utilities were observed to determine whether standards were being maintained and whether the operator/manager was concerned for cleanliness and the improvement of the general sanitation of the foodservice operation. Fifth, customer input was needed to learn whether FIP was improving customer satisfaction. Finally, an evaluation of top management's involvement in FIP was made to determine

Figure 1. FQAP Foodborne Illness Prevention Unit Evaluation Form.

FOODBORNE QUALITY ASSURANCE PROGRAM
Foodborne Illness Prevention
UNIT EVALUATION FORM

Organization:
Owner:

Evaluation Date:
Evaluator:

Foodservice Director:
Training:

Foodservice Manager:
Training:

Sanitarian:
Training:

Grade

1. UNIT OPERATION

- a. Policy manual represents actual operation. Manager knows the technical reason for each item. Manager is committed to QA and enthusiastic.
- b. QA employee training - written, scheduled progression training plan for initial, inservice and remedial training.
- c. QA organization responsibility - decentralize to employee teams who are making QA happen.
- d. QA HACCP recipes - complete and accurate.
- e. QA control - employee performance and tracking. Control charts are used to record employee progress, success and failure. Problems are handled promptly.

COMMENTS:

Grade

2. FOOD HANDLING

- a. Temperatures specified and controlled - receiving, storage, preparation, serving leftovers.
- b. Handling - promptness. No food is out over 45 minutes.
- c. Sanitizing surfaces - workers are effectively washing and sanitizing food contact surfaces.
- d. There are no unsafe practices.
- e. Food quality is being controlled. Sensory product development and QC being used.
- f. All food is packaged or covered.
- g. Food is cooled in less than 4 hours.

COMMENTS:

3. EMPLOYEES

- a. They know of and want QA.
- b. They know how to use HACCP. They understand temperature gradients.
- c. They are setting personal QA goals and achieving them.
- d. Personal hygiene is excellent. No employee illness, clean uniforms. Hair restraint is absolute. Handwashing systems and nail brushes are used. Fecal-oral transmission controlled.

COMMENTS:

4. FACILITY AND UTILITY

- a. Handwashing and bathroom facilities are superior.
- b. Area sanitation and cleaning will starve out insects.
- c. Area facilities maintained.
- d. Equipment maintained, including heating, cooling and preparation.
- e. Waste disposal.
- f. Dishwashing and pot/pan washing.
- g. Water, waste and plumbing are correct.

COMMENTS:

5. CUSTOMER SATISFACTION

- a. How do customers rate the food?
- b. How do customers rate the service?
- c. How do the customers rate the ambience?

COMMENTS:

6. TOP MANAGEMENT

- a. Policies and standards are established for accepting and rejecting products and processes.
- b. Top management is knowledgeable, committed, and reinforces the unit manager's actions in QA. There is coaching and counseling in how to improve quality.
- c. There is higher management QA effectiveness evaluation, and evaluation of the unit manager's self-inspection.
- d. QA improvement goals are established and accomplished at all levels.
- e. Higher management is effective in helping unit managers remove the cause of errors and problems.

COMMENTS:

LEVEL OF PERFORMANCE

- A: Technically complete, consistent outstanding performance.
 B: Good performance and good technical understanding.
 C: Satisfactory performance and satisfactory technical understanding.
 D: Usually acceptable performance, moderate technical understanding.
 F: Inconsistent performance, much lack of technical understanding.
 N: Cannot be judged.

TABLE 1. Evaluation performance scores.

Sections	Performance Mean ^a	Standard Deviation
Unit Management	4.119	0.8250
Food Handling	4.4779	0.4215
Employees	3.756	0.8725
Facility and Utility	4.342	0.6470
Top Management	4.407	1.0070
General Score	4.252	0.3972
Sanitation Score	89.190 ^b	7.0450

a. Level of Performance Scale for Individual Sections

- 5 - Technically complete, consistent outstanding performance.
- 4 - Good performance and good technical understanding.
- 3 - Satisfactory performance and satisfactory technical understanding.
- 2 - Usually acceptable performance, moderate technical understanding.
- 1 - Inconsistent performance, much lack of technical understanding.

b. Based on a possible score of 100.0 points.

the level of commitment and whether policies, standards and procedures were being specified by top management.

Results

The policy manual was examined for completeness and adaptation to each particular operation. It was found that 60 percent of the operations had the manual on the premises and, of those, 30 percent had the policies posted for employees to read and use as reference. Updating of the manual was found in 20 percent of the restaurants that had the manual on the premises. The hazard analysis and critical control points analysis of recipes was complete in approximately half the manuals.

The implementation of an effective employee training program was evaluated. Training programs were provided in 75 percent of the operations. These consisted of meetings held generally once a month. Knowledge and use of time and temperature controls for foods from receiving to consumption were evaluated. All operators/managers recognized the importance of proper time and temperature of food; 12.5 percent of the operations actually logged tem-

peratures at regular intervals. Others checked temperatures regularly, but did not log them. Thermometers were made available to employees in some operations.

The amount of leftovers had been reduced in 90 percent of the operations through menu revision that allowed for more "prepared to order" items. Cooling of foods in 2-inch full pans was observed in 85 percent of the operations.

Sanitizing was correctly performed in most operations. However, some were unsure of concentration levels in their cleaning solutions. All operators/managers were using a sanitizer and had established a cleaning schedule after attending the FIP course.

Employees in most of the operations were aware of FIP and approximately 20 percent had attended the course and were directly involved with FIP.

All facilities appeared to be clean and well maintained. No major problem areas were observed.

Policies and standards for accepting and rejecting products and processes were evaluated. Inquiries were made as to the knowledge of, commitment to, and reinforcement of the unit manager's actions concerning FIP. It was found that 93 percent of top management know of and are committed to FIP. Evaluation and self-inspection were evident in 70 percent of the operations.

Customer satisfaction was not measured. However, some establishments had their own evaluation forms and the operators/managers agreed that the evaluations helped them in the quality control of food and service. Customer comments included favorable ratings of the food, service and cleanliness of the foodservice establishment.

An analysis of the evaluation scores is shown in Table 1. These data show a narrow range of scores from 3.7 to 4.5. Food-handling procedures scored the highest in level of performance, while employee procedures scored the lowest. All the scores were above the satisfactory level. The correlation matrix in table 2 shows the most positive correlations as unit management vs. general score and top management vs. general score. The majority of the figures are slightly positive in their correlation. Table 3 indicates significant difference between the general score and the

TABLE 2. Correlation coefficient(*r*) matrix for the FQAP areas of evaluation.

	Unit Management	Handling	Employees	Equipment Facility	Top Management	Gen. Score
Food Handling	0.1675	-	-	-	-	-
Employees	-0.0539	-0.2019	-	-	-	-
Equipment & Facility	-0.1150	0.1951	0.2193	-	-	-
Top Management	0.3351	-0.1174	0.1591	-0.0842	-	-
General Score	0.6974	0.3553	0.4003	0.2004	0.6950	-
Sanitarian Score	0.4717	0.4106	-.5381	-0.1812	0.0033	0.1223

TABLE 3. Multiple regression analysis comparison of sanitarian's score with the evaluator's score.

	Coefficient	Standard Error	t-Test value
Unit Management	-0.80809	2.468621	-0.33
Food Handling	2.287913	1.30410	1.78*
Top Management	4.365018	3.417249	1.28
General Score	3.6376	1.337862	2.72**

*Significant at the ≤ 10 percent level.

**Significant at the < 5 percent level.

sanitarian's score. A scatter plot of the general score and the sanitarian's score revealed no significant pattern.

Discussion

In the two years that Moorhead has had mandatory FIP training, there have been definite improvements in the food-handling areas. Some of these include:

1. Increased use of thermometers.
2. Faster and more efficient means of cooling food.
3. The use of refrigeration for thawing.
4. Organization of food items in the cooler (e.g., cooked foods stored above raw foods).

Refrigeration techniques were the key area of concern in most operations. Greater use of time/temperature relationships to insure the safety of foods was evident. This showed a growing awareness of problem areas and of corrective procedures that could be used. Many persons who took the course were able to relate at least one procedure they changed after completing it. This speaks well for the FIP course because the first learning goal is that the student will be able to specify safe food-handling procedures.

An area that needs more assertiveness and enthusiasm from management is employee training. The evaluation score supports this. The main emphasis of the policies, procedures and standards manual is on food-handling procedures, but employee training is also important. It is necessary that the manager be willing to teach the employees FIP principles and to follow up and reinforce this teaching. This is dependent on the manager's ability to learn new

material and teach it to the employees. The teacher has to be effective and motivated in training (Kondrasuk, 1979).

It was found that the more complete the policy manual, the more the policies were enacted and followed. This reinforces the need, as pointed out by Holland (1980), for top management commitment and participation in the FIP program. There were also more meetings being held and the manager was teaching FIP to the employees.

If the operator/manager is actively using his or her policies, then theoretically there should be no chance for a foodborne illness outbreak. Prevention is the key. The FIP course is designed to teach prevention of potential problems through recipe design. Periodic organizational audits must be conducted to assure adherence to quality policies, procedures and standards.

Allowing the employees to establish their own performance goals and objectives in striving for a quality product is a way in which employees are made to feel part of the group. The employees are a resource that must be used to the utmost. They are the ones who perform the operating tasks and are aware of what works and what does not. Active participation in FIP also can aid in preventing problems and provide a means of solving problems immediately.

Knowing that the employee is involved in and cares about the quality of the work is an additional element in customer satisfaction. Meeting the quality expectations of the customer is the goal of the establishment. Today's customer is looking for value, where value is defined as the quality in relation to the price paid. An active use of FIP in preventing operating errors will assure meeting those expectations.

The FIP course has also expanded the communications between the sanitarian and the operators/managers because there is a common base of knowledge from which to discuss specific food-handling techniques and sanitation problems. Sanitation traditionally has not been oriented toward recipe process. With the implementation of the FIP course, the times and temperatures of food handling, refrigeration, thawing, and cooking are emphasized during inspections.

A survey done by the Minnesota Department of Health of 29 restaurants in Moorhead found that the certification program is an important and efficient method of training food-handling personnel and a significant step in upgrading the quality of the foodservice industry (Minnesota Depart-

ment of Health, 1979). The department rated the Moorhead foodservice sanitation program as good to excellent.

The FIP course points out the financial advantage to having a safe, high-quality product. Low-quality, unsafe food does not produce profits. The customer has the choice of returning to a restaurant or not, and the repeat customer is a very valuable asset.

Summary

The FIP course has provided knowledge to the restaurant operators/managers. But, to be effective, the knowledge must be transferred to the employees who, in turn, must use the information. Moorhead has been a proving ground for a mandatory FIP program. However, the effectiveness of the program depends on the manager's motivation and ability to plan, organize, direct and control the FIP function. The sanitarians play an important role in the motivation of managers and hence must be supportive of the program and make themselves available as resource persons as well as inspectors (Snyder, 1981).

REFERENCES

1. Davis, A. S. 1977. Sanitation training for foodservice managers--A must! *J. Food Prot.* 40:198.
2. Division of Environmental Health. 1979. Evaluation of foodservice sanitation program, Moorhead, MN. Minnesota Department of Health, Minneapolis, MN. p. 15-16.
3. Food and Drug Administration. 1976. Foodservice recommended ordinance and code. US Department of Health, Education and Welfare, Public Health Service, DHEW publication No. (FDA) 78-2081. Washington, DC.
4. Holland, G. C. 1980. Education is the key to solving sanitation problems. *J. Food Prot.* 43:401-403.
5. Kondrasuk, J. 1979. The best method to train managers. *J. Training and Development.* 33(8):46-48.
6. Snyder, O. P., Jr. 1975. Minnesota Quality Assurance Program for the Prevention of Foodborne Illness. University of Minnesota, St. Paul.
7. Snyder, O. P., Jr. 1979. Preventing Foodborne Illness-A Quality Assurance Program for Foodservice Operations. Special Report 61. 3rd ed. University of Minnesota Agric. Ext. St. Paul, MN 71 pp.
8. Snyder, O. P., Jr. 1981. A model foodservice quality assurance system. *Food Technol.* 35:70.

Welcome. . . New Members and Subscribers to the IAMFES Family...

Sheridan Green
Glendale, CA

Michael Hauer Library
Philadelphia, PA

Leslee Crouch
Carrollton, TX

Centre De Documentation
Maroc, France

Deanne Zulaica
Modesto, CA

David Tuttle
Klenzade Div. Economics Lab.
Knoxville, TN

Mr. Choong Il Jeong
Seoul Dairy Co
Korea

Charles P Martin
Auburn, AL

Kawang-Il
Korea

George Rybak
Flavorcraft Inc.
Burbank, CA

Dr. Jonathan C. Hoskin
Dairy Science Dept. Clemson, SC

Packard Instrument Co., Inc.
Downers Grove, IL

Queens College Library
Flushing, NY

Christ Christensen
Humboldt Creamery Assn.
Fortuna, CA

Tacoma-Pierce Co. Health Dept.
Tacoma, WA

Roy J. Kaiser
Cincinnati, OH

USAF Clinic
McGuire AFB, NJ

Joel C. Coble
Pierce Packing Co.
Billings, MT

USFA Hospital
APO San Francisco, CA

Robert Joselyn
Viatran Corp.
Grand Island, NY

John R. McGlamry
NC Dept. of Agric.
Raleigh, NC

USAF Hospital
Wurtsmith AFB, MI

Richard P. Kuehn
Burnsville, MN

Robert H. Vint III
Mesquite, TX

Richard W. Ifkorits
Whirlpool Corp. R & E Center
Benton Harbor, MI

Gant's Foods Ltd.
South Africa

P. Zipchen
Saskaatoon, CN

Dan Brooks
National Foods Processors Assoc.
Seattle, WA

Kenneth R. Wheeler
Billings Dairy
White River Junction, VT

J. A. Banks
Bath University
Avon, England

Larry Hemmingsen
Albert Lea, MN

Robert E. Holtgrieve
Waukesha, WI

N. A. Pfenning
Wisconsin Beef Industries
Eau Clair, WI

Minburn-Vermillion Health Unit
Alberta, CN

David L. Hagen
Gama Services, Ltd.
Saudi Arabia

Carl A. Smith, Jr.
The Pillsbury Co.
Minneapolis, MN

Vantaan Terveysvirasto
Finland

ANTIBIOTIC FORMULATIONS FOR DRYING OFF THERAPY OF DAIRY CATTLE

W. DONALD SCHULTZE

Milk Secretion and Mastitis Laboratory
 USDA-ARS, Beltsville, MD 20705

Antibiotic treatment of intramammary pathogens of the dairy cow has the best chance of success and the fewest disadvantages when the cow has just completed lactation. A variety of complex chemical and biological processes determine how much of a drug dose is actually effective. An ideal formulation for dry cow therapy would contain antibiotic(s) able to kill all the various pathogens likely to invade the gland and would release the drug slowly over several weeks time. The antibiotic would be bound fairly strongly to proteins in the mammary secretion in order to maintain a drug depot, and would have a high absorption rate into mammary tissue so as to get active drug into contact with the pathogens.

Over most of the dairying world, dry cow therapy (DCT) is one of the cornerstones of modern mastitis control. The details of the practice vary, but generally it involves the infusion of a large dose of antibiotic into each mammary quarter of the cow just after the final milking of her lactation. There have been a wealth of publications on DCT -- on ways of applying it and on degrees of success observed with different antibiotics and dosages. However, those of us who treat dairy cattle or are concerned with safeguarding milk quality may find it more difficult to piece together a general understanding of the theory behind the practice. How are the proper antibiotics selected, how are they formulated into a treatment product, what happens to the antibiotic in the unique environment of the dry udder? As a non-pharmacologist, I can share the results of my own attempt to acquire a simplified picture of this rather complex subject.

Goals of Antibiotic Therapy. First, we must select an effective antimicrobial agent, one that is active against nearly all strains of the bacterial pathogens that we expect to encounter. Among diseases of man and other animals, mastitis is a particularly difficult problem in this regard. Mastitis can be caused by many different bacteria, and we usually cannot spend the time and money to identify the ones present and determine their pattern of antibiotic sensitivities. Thus, the commercial treatment products are designed to be effective against the most common mastitis pathogens: *Staphylococcus aureus* and *Streptococcus agalactiae*, in particular.

The product may contain one broad-spectrum antibiotic,

effective against a great variety of bacteria, or it may contain several antibiotics, each active against a narrower range. Multi-drug preparations are few in number these days. The FDA requires that if such a formulation is to be approved, each antibiotic must be shown to make a separate contribution to the efficacy of the product. The optimal concentration of each in the mixture must be determined from experimental evidence. This is a wise restriction, but is a very expensive requirement for the manufacturer. One such product, a combination of penicillin and dihydrostreptomycin, is available for intramammary use in DCT. In this, the combination of antibiotics shows a uniquely valuable effect -- not merely additive, but synergistic. In other words, the presence of each antibiotic makes the other more effective than it would be alone.

We are seeing reports that indicate a changing pathogen distribution in mastitis. Especially in herds that have practiced good mastitis control, new infections are likely to be caused by *Streptococcus uberis* and other non-agalactiae streps, *Staphylococcus epidermidis* and coliform bacteria. These are organisms common to the cow's environment, for which infected udders are not necessary as sources of spread. Also, these are the species likely to cause most of the new infections in the early dry period. Will our old established antibiotic preparations deal effectively with the shift in pathogens? It appears from some recent field studies that they will. Most of the environmental staphylococcal and streptococcal pathogens are susceptible to penicillin, cloxacillin, novobiocin or the cephalothin group of antibiotics.

The coliforms are a different kettle of fish. Experiences as to their antibiotic sensitivity vary widely. *In vitro* testing showed us that none of the antibiotics permitted in today's dry cow products were effective against the majority of strains of *Escherichia coli* from the Beltsville herd. The coliforms entered glands quite frequently at drying off, but they rarely survived until the next calving. Apparently, the strongly inhibitory effect of lactoferrin in the dry udder suppressed them. In this one situation, the cow's natural defenses seem to handle the problem nicely.

More is required of an antibiotic than efficacy against bacteria in a laboratory test. We must be able to get a therapeutic concentration of the drug at the site of infec-

tion. In intramammary infusion therapy, we have the great advantage of being able to put the drug into close proximity to the invading pathogens. For many infections of man and other animals this is not possible. There are problems of getting the drug from the alimentary tract or an injection site in muscle tissue into the blood stream, and from there to sites of bacterial multiplication that we may not be able to pin-point.

The antibiotic must not only reach the bacteria, it must remain there at an effective concentration long enough for all of them to be destroyed. There is danger in permitting too short a contact time. You see, a population of thousands or millions of cells of a pathogen will not likely be equally sensitive to a given antibiotic. Some few of the bacteria will be more resistant. Normally, this is no problem in treatment, because body defenses can handle this small proportion of the invaders. But, suppose we treat the infection with an antibiotic for less time than necessary to eliminate it completely. Some bacteria cells will remain as survivors -- the more resistant ones. As they multiply again, now with no competition, the infection site will be repopulated with bacteria that are nearly all more resistant to the antibiotic. The chance for successful retreatment of the infection with the same antibiotic is very poor.

This cautionary note against casual or inadequate treatment with antibiotics should not just be filed away under "mastitis". It applies equally to infections in the human body. So, in distinct contrast to the conservative philosophy that guides most drug administration, the watchword in antibiotic therapy is: Use enough, and use it long enough!

The Dry Udder as Target for Antibiotic Therapy. The dry udder has some important advantages over the lactating udder as the site of our attack on intramammary infection (3). We can maintain a more constant level of antibiotic over the short time span because the gland is not being emptied twice each day. Also, we are spared the expense of discarding antibiotic-contaminated milk. We avoid the danger of inadvertently contaminating the human food supply by shipping milk before the last of the antibiotic has disappeared from the udder. For this reason, we are permitted by FDA to treat dry udders with far higher doses of antibiotics than are allowed in lactating udders. Additionally, and very importantly, treatment cures a much higher proportion of infections in dry udders than in lactating ones. This may be due largely to the longer contact time with higher drug concentrations, but it may also be due to better tissue penetration of the drug in the involuting gland. In any event, there is a therapeutic advantage that should not be missed. Finally, the prophylactic opportunity must be kept in mind: to prepare the udder at drying off with a high concentration of antibiotics to meet the onslaught of early dry period invasion by pathogens.

Gideon Ziv (5) has summarized the desirable characteristics of an antibiotic preparation for dry cow therapy.

1. The product must be completely non-irritating. Any degree of induced irritation of the involuted gland can be expected to damage the milk secreting tissue.

2. The antibiotic should be effective at low concentration, and preferably be bactericidal (kill the bacteria, rather than merely stop their multiplication). This is important so that, as the dry period progresses and the antibiotic concentration declines, there will be the least likelihood of emergence of a surviving bacterial population with increased antibiotic resistance.

To my knowledge, there is no published evidence of such emerging resistance. However, we recently did a long study of DCT at Beltsville, using penicillin and dihydrostreptomycin, in which most of the surviving pathogens became resistant to these two antibiotics. This was no danger to the herd, because so few bacterial strains survived the treatment. Still, I believe that emergence can occur, and if a less effective treatment product were to leave many surviving infections, the health of the herd could be threatened.

3. The antibiotic should be strongly bound to dry udder secretions and to udder tissue proteins, it should be chemically a strong acid or base, it should be highly hydrophilic in nature, and should have a high molecular weight. These are properties that act to bind the drug within the mammary gland and minimize its loss by diffusion into the blood stream and the excretory system. Such properties will permit the progressive release of free and active drug, which can then be absorbed into the mammary tissues.

4. The objective is to provide stable antibiotic activity in dry udder secretions for at least 3 weeks. This would carry us nicely through the early dry period of high susceptibility to infection. It does not, however, provide sufficiently long lasting protection to deal with another period of high susceptibility -- at the end of the dry period and at calving. Some people advocate retreating cows later in the dry period, but I don't favor it. There is increased danger of antibiotic residues persisting beyond the time of colostrum discard after calving, especially from the cow that calves early. Furthermore, tissue residues of antibiotic could prevent us from culling the odd cow with a serious calving-related problem. Ziv (6) has argued against retreatment because during involution there is a great reduction in the glandular parenchyma and duct system, and the antibiotic would not be well distributed through the gland. On balance, I think that we must consider peripartum infection as a problem to be attacked apart from DCT.

Bioavailability: Getting the Drug to the Bug. If the bottle label states that there are 100 milligrams of antibiotic in each 10 milliliters of liquid, and I dutifully swallow 10 milliliters of it, will the entire 100 milligrams of drug go to work against my infection? It is not very likely, for a host of things can happen to the molecules of that antibiotic. That portion of the dose that actually reaches the infection site in active form is the portion that is called bioavailable (2).

A common problem that pharmacologists must deal with is getting and maintaining a drug level in the circulating blood compartment. (Portions of the body in which a drug may be rather uniformly distributed, such as blood, organs, or urine, and which are separated from each other by mem-

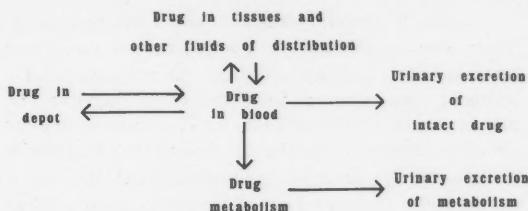

Figure 1. Compartmental analysis of drug distribution (2).

branes that restrict passage of the drug in or out, are called compartments by the pharmacologist.) Unless put directly into the blood stream, the drug must be carried from somewhere else in the body, at a rate dependent on the difficulty of passage from one body compartment to another. Conversely, as soon as some of the drug reaches the blood stream, other rates of transfer become active -- into tissue fluids and urine, for example. You can't just put a drug in and expect it to stay here. The level of the drug that is maintained, and how long it is maintained, is determined by the summation of many rates of transfer between various body compartments.

To further complicate matters, the drug is being metabolized -- changed enzymatically into inactive chemical forms. Pharmacologists are rarely able to estimate the individual rates of diffusion, metabolism and excretion that determine the bioavailability of a certain dose of drug in a particular application. Instead, they analyze for the concentration of the drug in samples of blood and urine, collected at a succession of times after administration of the drug, and thus learn the overall effect of the many processes. For many mastitis treatment forms and drugs, even this sort of bioavailability study is lacking.

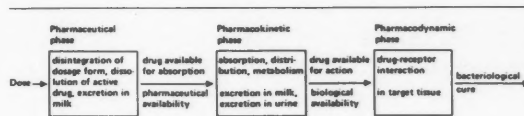

Figure 2. Schematic representation of sequential events influencing contact between udder pathogen and antibiotics after intramammary infusion (6).

For the situation of our particular interest, the dry udder of the dairy cow, Gideon Ziv recently reviewed the pharmacology of mastitis therapy (6) and presented the following diagrammatic summary. Chemical modifications that have been made in the basic drug molecule, and materials that have been added to it in formulating the preparation for therapeutic use, largely control the outcome of events in the pharmaceutical phase. Biological processes taking place within the udder dictate the end results of the pharmacokinetic phase. These two phases determine the extent of bioavailability.

The Pharmaceutical Phase of Its Manipulation. In this first phase, the dose of drug disintegrates, and the drug is released from the inert carrier substances. It is now actually in the milk, distributed between the aqueous (watery)

and the lipid (fatty) fractions of milk in the gland cistern and major milk ducts. What proportions of the drug pass into these two fractions depend on the oil-to-water partition coefficient that is characteristic for the drug molecule. This phase is quite important in formulating for DCT, because the pharmacologist can do a lot to control the time and concentration relationships of the antibiotic within the gland.

Here are a few of the methods by which the chemist can increase persistence of an antibiotic by prolonging the time of its release from a carrier base (1): the drug can be incorporated into a particulate matrix; it can be absorbed to insoluble, inert compounds; it can be microencapsulated. A big step in improving DCT was the development of a mineral oil base with 3% aluminum monostearate added. Uvarov (4) showed how dramatically this long-acting base could extend the activity of a single dose of an antibiotic.

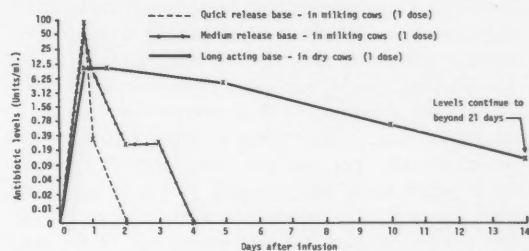

Figure 3. Representation of antibiotic levels in the milk after infusion of different preparations (4).

Antibiotics have been reported to persist longer in the dry mammary gland in a mineral oil base than in vegetable oil. Still, currently marketed products use peanut oil gel. One product specifies, in greater detail than most, that the base contains 1% hydrogenated peanut oil plus 3% aluminum monostearate (a fatty substance) in peanut oil. I think we must accept the fact that drug formulation cannot be a cut-and-dried application of certain chemical principles. Like cheesemaking, it combines science and art.

The Pharmacokinetic Phase and Its Manipulation. In this phase, we are concerned with the many processes that determine the antibiotic concentration in the dry udder secretion and, in turn, how much of that actually gets into the mammary tissue. Some antibiotic is lost by metabolic changes. Some is lost by diffusion into the blood stream, and from there by excretion in the urine. As for the remaining antibiotic, the oil-to-water partition coefficient is important in determining its fate. Because the membranes that separate small ducts and secretory tissue in the mammary gland are rich in lipids, the degree of lipid solubility of the antibiotic determines how readily it can move across these membranes. Pathogens such as *Staphylococcus aureus* are active invaders of the mammary tissue, so it is essential that the antibiotic be able to penetrate tissue to reach them.

To some extent, the pharmaceutical chemist can manipulate the rates of these diffusions. Since the drug must dissolve before it can be absorbed, delaying dissolution is a way of slowing absorption. For example, we can consid-

er the development of ideas on delaying absorption of penicillin (*I*) to make a slow-release product. First, they slowed dissolution by suspending the calcium salt of penicillin G in a water-immiscible medium containing oil and beeswax. Then they found that absorption could be retarded even more by substituting less soluble compounds of penicillin itself. The first such was procaine-penicillin -- an equimolecular compound of penicillin and procaine in crystalline form. When a suspension of these crystals is administered, they dissolve slowly at the site of injection. Later, an even less soluble conjugated form of penicillin was discovered -- benzathine penicillin. This form of the antibiotic will maintain a low concentration of active penicillin for weeks after a single dose.

In addition to the chemical nature of the drug molecule, there is another property that plays an important role in diffusion equilibria in the dry udder. Antibiotics can be bound to proteins -- in fixed tissues, in blood, and in milk and dry udder secretion. The extent of this binding is different for different antibiotics, and has important implications for bioavailability (6). On one hand, extensively bound antibiotics, such as polymyxin B, novobiocin and streptomycin, are restricted in their ability to diffuse across biological membranes. They tend to remain where they are put. On the other hand, they will tend to stay bound in the gland secretion, whereas we want them to move into the deep tissues. Besides, the antibacterial part of the drug molecule is covered up when the drug is bound to protein, so only free antibiotic is active against the pathogen. How is it, then, that these antibiotics are useful in therapy?

Fortunately, protein binding is not a one-way street. There is an equilibrium, or dynamic balance established between bound and free antibiotic. As molecules of free antibiotic are removed from the gland secretion, by metabolism or by diffusion into the deep tissues, some of the bound antibiotic molecules are released from the protein. And so the equilibrium is maintained. Thus, we have a mechanism to hold a supply of antibiotic bound in place and to gradually release a portion of this supply in free and active form.

We have developed quite a difficult assignment for an optimal antibiotic to be used in dry cow therapy. As Ziv has pointed out (6), no single antibiotic formulation presently available does all the things that we desire. Still, the body of pharmacological information is growing, and there is hope for future products that will more nearly meet the ideal.

REFERENCES

1. Garrod, L. P. and F. O'Grady. 1971. Antibiotic and chemotherapy, 3rd. Williams and Wilkins Co., Baltimore. 485 p.
2. Notari, R. E., J. L. DeYoung, and R. C. Anderson. 1975. Biopharmaceutics and pharmacokinetics, an introduction, 2nd ed. Marcel Dekker, Inc., New York. 285 p.
3. Uvarov, O. 1970. The role of therapy in mastitis (when and how to treat). Proc. 9th Annu. Meeting Nat. Mastitis Council, p. 27-37.
4. Uvarov, O. 1971. Drugs against mastitis. Vet. Rec. 88:674-678.
5. Ziv, G. 1975. Pharmacokinetic concepts for systemic and intramammary antibiotic treatment in lactating and dry cows, p. 314-340. In F. H. Dodd, T. K. Griffin, and R. G. Kingwill (ed.) Proc. IDF seminar on mastitis control. Internat. Dairy Federation, Bruxelles.
6. Ziv, G. 1980. Practical pharmacokinetic aspects of mastitis therapy. Vet. Med./Small Animal Clinician 75:277-290, 469-474, 657-670.

World Champions St. Louis Cardinal Baseball

Spurred by the extreme interest of attendees at the Interstate Milk Shipment Conference in St. Louis in May regarding the Cardinal baseball game that was scheduled, your Local Arrangements Committee for the 70th Annual Meeting of the IAMFES plans to make baseball available. On page 226 is an order blank for reserved tickets to the one baseball game Sunday, August 7, 1983 which is scheduled during the International Meeting. Get your request in early with your advance registration so that tickets may be obtained in a block so you and all your friends will be sitting together.

Secondly, the Local Arrangements Committee has arranged Baseball Entertainment Night in the hotel on Monday, August 8, 1983 immediately following the slide presentation of Mr. and Mrs. Ivan Parkin. There will be movies of the 1982 World Series between the St. Louis Cardinals and the Milwaukee Brewers and, time permitting, World Series movies involving the St. Louis Cardinals in former years. Since attendees will only have the Sunday opportunity to see live baseball, every effort is going to be made to create a baseball atmosphere including the serving of usual park refreshments in the hotel on that Monday night.

See you there!

International Association of Milk, Food and Environmental Sanitarians, Inc.

MEMBERSHIP APPLICATION

All memberships on calendar year basis. Memberships include subscription to *Journal of Food Protection*, *Dairy and Food Sanitation*, or both journals.

BEST BUY Check one:

- I want to receive BOTH journals \$50
 I want to receive *Dairy and Food Sanitation* \$28
 I want to receive *Journal of Food Protection* \$40

FOREIGN:
Add \$7 for each Journal ordered for postage

*Student Membership \$10 for 1 Journal - \$20 for both — please include student verification

SUBSCRIPTION APPLICATION for agencies, associations, and institutions

All subscriptions on a calendar year basis.

BEST BUY

- BOTH Journals \$75
 Dairy and Food Sanitation \$60
 Journal of Food Protection \$60

FOREIGN:
Add \$7 for each Journal ordered for postage

PUBLICATION ORDER FORM

3-A Sanitary Standards

- () Complete set 3-A Dairy ea \$20.00
 () Complete set 3-A & Egg 3-A Stds ea \$25.00
 () Egg 3-A Stds ea \$15.00

Five-Year Service on 3-A Sanitary Standards

- () 3-A Stds Five years \$12.00
 () Egg 3-A Stds Five years \$ 6.00

- Procedures to Investigate Waterborne Illness ea \$ 1.75
 25-99 copies, \$1.50 ea., 100 or more, \$1.15 ea
- Procedures to Investigate Foodborne Illness ea \$ 1.50
 25-99 copies, \$1.25 ea., 100 or more, \$.90 ea.

Please fill out completely

Name _____ Company Name _____

Address _____

City _____ State _____ Province _____ Zip _____

- Payment enclosed
 Mastercard/Visa (circle appropriate card)
 Card # _____
 Expiration Date _____
- Bill me (payment due upon receipt)
 Please check here if you would like information
 on joining your state/province association.

MAIL ENTIRE FORM TODAY TO:

IAMFES—Dept. C
 P.O. Box 701
 Ames, IA 50010

For faster service use your
 charge card & call
 515-232-6699
 extension C

News and Events

Richardson Receives Harold Macy Award

Dr. Gary H. Richardson, Professor in the Department of Nutrition and Food Science at Utah State University has been selected as the 1983 recipient of the Harold Macy Food Science and Technology Award by the Minnesota Section of the Institute of Food Technologists. The award, which was established in 1981, is given annually for an outstanding example of food technology transfer or cooperation between scientists or technologists in any two of the following settings: academia, government, or private industry.

Dr. Richardson's research in the area of bulk starter culture preparation is an excellent example of technology transfer and cooperation between a University Scientist and private industry. One of the greatest problems of the cheese industry has been associated with unpredictable performance of lactic starter culture. The development of bacteriophage-inhibitory media in the early 1980's was a significant development, but by 1975 the cost of these media had reached a point where it was a significant factor in the cost of cheese production. Dr. Richardson conceived the idea that with proper nutrient supplementation and automatic pH control, cheese factories could utilize their own whey for making bulk culture media. He solicited the cooperation of the management and starter technologists at the Cache Valley Dairy Association in Utah. This plant processed about 700,000 pounds of milk daily into Swiss, Monterey, and Cheddar cheese. After the first year of operation, the plant reported savings in culture costs in excess of \$150,000. The whey-based pH control starter system developed by Dr. Richardson is now being used in at least 60 cheese factories throughout the United States and Western Canada, and the number is steadily increasing. The system is now also serviced by most of the culture supply houses in the United States. During the summer of 1981 Dr. Richardson was invited to Ireland to introduce the whey-based pH control culture system to the dairy industry in that country.

American Association of Cereal Chemists Announces 68th Meeting

The American Association of Cereal Chemists announces its 68th Annual Meeting to take place October 30-November 3, 1983 at the Hyatt Regency and Crown Center Hotels, Kansas City, MO.

The technical program will include the following symposia: Cereal Polysaccharides - Their Role in Technology and Nutrition; The World Needs Bread:

Nutrition - Product- Controls; Digestibility and Amino Acid Availability in Cereals and Oilseeds; Mycotoxins in Cereal; HPLC - Its Role in Cereal Chemistry; Variability in Nutrient Content of Cereal Grains; Rice Research Workshop.

In addition to the technical sessions, meeting registrants may attend New Products Sessions, table top exhibits, and a wide range of special events, social events and spouse events.

For more information contact AACC Annual Meeting, 3340 Pilot Knob Road, St. Paul MN 55121, 612-454-7250.

Oswalt Named Dairyman of the Year

William Oswalt of Vicksburg, Michigan was named the 1983 Dairyman of the Year by the Michigan State University Department of Animal Science.

The award was presented March 21 to Oswalt and his wife, Patricia during the Michigan Dairy Awards Luncheon at MSU's Kellogg Center during Farmers' Week and Natural Resources Days, March 21-25.

The annual award is given on the basis of the recipient's contribution to Michigan's dairy industry, the quality of the farm's dairy herd and the family's involvement in community affairs.

Harper Recipient of DFISA Food Engineering Award

Dr. Judson M. Harper, Interim Vice President for Research at Colorado State University, has been selected for the biennial Food Engineering Award of Dairy and Food Industries Supply Association and American Society of Agricultural Engineers.

The honor is given in recognition for outstanding original research, development, design, management of food processing equipment or processes. The Award consists of a \$2,000 stipend, gold medal and commendation certificate.

Presentation of the Award was made on April 12, 1983 by DFISA President Carl Nielsen at the Association's 64th Annual Conference in Boca Raton, FL.

Dr. Harper was selected for the prestigious Award for his outstanding contribution to the Food Engineering profession, both in industry and academia.

Filled Milk Law Resumed Against Meadow Fresh, Inc. in KY.

The Franklin County Circuit Court ruled March 2, 1983, that enforcement of provisions of the "filled milk law" shall be resumed against Meadow Fresh, Inc., Salt Lake City, UT, by the Department for Health Services. A period of ten days has been granted the company for their notification of clients.

Filled milk is defined in the Kentucky Food, Drug, and Cosmetic Act as milk products from which the milk fat has been removed and to which has been substituted vegetable fat or oil so that the resulting product is an imitation or semblance of milk, cream, skimmed milk, ice cream mix, or frozen dessert, whether or not condensed, evaporated, concentrated, frozen, powdered, dried or desiccated, whether in bulk or in containers hermetically sealed or unsealed.

Meadow Fresh representatives in Kentucky obtained a "restraining order" against the Cabinet for Human Resources and the Department for Health Services, August 4, 1982. This order prevented the Department for Health Services from taking any action under KRS 217 against the plaintiffs to prohibit or attempt to prohibit the sale, delivery, distribution, or offering for sale of Meadow Fresh Imitation Lowfat Dry Milk.

During the time the restraining order was in effect, Meadow Fresh representatives have been soliciting sales to individuals, nursing homes, day care centers and schools.

According to the Louisville Dietetic Association, Meadow fresh products are nutritionally inferior to whole milk products in that they contain less protein and calcium. Also, coconut oil, which the product contains, is highly saturated and less desirable in the diet than cholesterol.

According to the Milk Control Branch within the Department for Health Services, Meadow Fresh products have not been offered for sale through retail stores, but on a personal contact basis and through multi-level contract arrangements.

The Milk Control Branch shall continue to enforce the filled milk law against anyone found to be offering filled milk products on an individual basis or through retail stores.

NEM Offers New Film Program

"Sanitation and Hygiene for Dining Room Personnel," a new film program from National Educational Media, Inc., (NEM), demonstrates techniques of sanitary food handling for waiters, waitresses and buspersons.

According to NEM president Jack Copeland, "Dining

room personnel have a responsibility as serious as their commitment to courtesy and good service. This program shows the behind-the-scenes habits of personal hygiene and dining room sanitation that assures a healthy dining experience for an establishment's guests."

Copeland noted that the program updates and completely replaces one of NEM's most successful films. He added that it also provides an ideal companion for "Sanitation and Hygiene: Why the Importance?" and "Sanitation and Hygiene: Basic Rules," two of the most widely used NEM programs. All three ten-minute color motion pictures can be presented individually or as a unit.

For more information contact: NEM, 21601 Devonshire St., Chatsworth, CA 91311, 213-709-6009.

Pollei Elected President of the Whey Products Institute

Mr. H. "Jack" Pollei, Galloway West Co., Fond du Lac, Wisconsin, was elected President of the Whey Products Institute at the Institute's 12th Annual Meeting held in Chicago on April 13-14, 1983. Mr. Pollei, who has been a member of the Board of Directors since 1979, previously had served as Vice-President; he also is a member of the Institute's Executive Committee.

Mr. Donald C. Storhoff, Wisconsin Dairies Cooperative, Baraboo, WI, was elected Vice-President; and Nico van Zwanenberg, Cuba Cheese, Inc., Cuba, NY, was re-elected Secretary-Treasurer. Newly elected as a Director of the Institute was Daniel S. Hanson, Land O'Lakes, Inc., Eau Claire, WI.

American Dry Milk Institute Re-elects Ringenberg as President

Mr. John M. Ringenberg, Mid-America Dairymen, Inc., Springfield, MO, was re-elected President of the American Dry Milk Institute at the Institute's 58th Annual Meeting held in Chicago on April 13-14, 1983. Mr. Ringenberg previously had served as Vice-President of the organization; he is a member of its Executive Committee, and has served on a number of standing committees since being elected to the Board of Directors in 1964.

The American Dry Milk Institute, founded in 1925, is the national trade association of the dry milk industry. The Executive Director of the Institute is Warren S. Clark, Jr.

NATIONAL MASTITIS COUNCIL

1983 Summer Meeting Program

Thursday, August 11, 1983

Marriott Pavillion Hotel

St. Louis, Missouri

THEME: SHOW ME HOW IN 1983

Presiding — John S. McDonald, National Animal Disease Center, Ames, IA

- | | |
|------------|---|
| 8:00 a.m. | Registration |
| 8:30 a.m. | Greeting - Arlen Schwinke, National Mastitis Council, President, Morrison, MO; Greetings - Richard Palmer, Missouri Mastitis Council, President, Old Monroe, MO |
| 8:40 a.m. | Effective Communications - Allen Bringe, Extension Dairyman, University of Wisconsin, Madison, WI |
| 9:00 a.m. | Investigations of Herds with a High Incidence of Mastitis - Ralph Farnsworth, Univ. of Minnesota, St. Paul, MN |
| 9:30 a.m. | Milk Break |
| 9:45 a.m. | Sizing Milking Systems - Steve Spencer, Pennsylvania State Univ., University Park, PA |
| 10:15 a.m. | Common Errors in Milking Procedures - David McQueen, Univ. of Illinois, Urbana, IL |
| 10:45 a.m. | Preventive Management of Mastitis Due to "Environmental" Bacteria - Richard Bennett, Univ. of California, Santa Rosa, CA |
| 11:15 a.m. | Questions for Morning Speakers - Barry Stevens (moderator) |
| 12:00 noon | Lunch |
| 1:30 p.m. | Mastitis Treatment and Antibiotic Residues - Jenks Britt, Russellville, KY |
| 2:00 p.m. | Residue Avoidance Program - John Adams, National Milk Producers Federation, Arlington, VA |
| 2:20 p.m. | Dairy Extension Residue Avoidance Projects - Basil Eastwood, Federal Dairy Extension Service, Washington, D.C. |
| 2:40 p.m. | Questions for Afternoon Speakers - Don Rollins (moderator) |
| 3:10 p.m. | Wrap-Up - Ewing Row, Hoard's Dairyman, Fort Atkinson, WI |
-

3-A Sanitary Standards for Mechanical Conveyors For Dry Milk and Dry Products

Number 41-00

Formulated by
International Association of Milk, Food and Environmental Sanitarians
United States Public Health Service
The Dairy Industry Committee

It is the purpose of the IAMFES, USPHS, and DIC in connection with the development of the 3-A Sanitary Standards program to allow and encourage full freedom for inventive genius or new developments. Mechanical dry milk conveyor specifications heretofore or hereafter developed which so differ in design, material and construction, or otherwise, as not to conform to the following standards but which, in the fabricator's opinion, are equivalent or better, may be submitted for the joint consideration of the IAMFES, USPHS, and DIC at any time.

A.

SCOPE

A.1

These standards cover the sanitary aspects of mechanical equipment used solely for conveying dry milk and dry milk products except bucket types and are not an integral part of the dryer, commencing with the point at which the product enters the conveyor and ending at the point the product is discharged from the conveyor.

A.2

In order to conform with these 3-A Sanitary Standards, mechanical dry milk conveyors shall comply with the following design, material and fabrication criteria.

B.

DEFINITIONS

B.1

Product: Shall mean the dry milk or dry milk product which is mechanically conveyed in this equipment.

B.2

Dry Milk Conveyors: (Referred to hereinafter as "conveyors") Shall mean equipment in which product is mechanically conveyed.

B.3

Product Contact Surfaces: Shall mean all surfaces that are exposed to the product and surfaces from which liquids and/or solids may drain, drop or be drawn into the product.

B.4

Non-Product Contact Surfaces: Shall mean all other exposed surfaces including support surfaces within 6 inches of the conveyor housing.

B.5

Mechanical Cleaning or Mechanically Cleaning: Shall denote cleaning, solely by circulation and/or flowing chemical detergent solutions and water rinses onto and over the surfaces to be cleaned, by mechanical means.

C.

MATERIALS

C.1

Product contact surfaces shall be of stainless steel of the AISI 300 series ¹ or corresponding ACI ² types (see Appendix, Section E.), or metal which under conditions of intended use is at least as corrosion-resistant as stainless steel of the foregoing types and is non-toxic and non-absorbent, except that:

C.1.1

Rubber and rubber-like materials may be used for gaskets, flexible connectors, edge sealing strip, belts, belts with integrally molded cleats, and coverings for belts and rollers.

C.1.2

Rubber and rubber-like materials when used for the above specified applications shall comply with the applicable provisions of the 3-A Standards for Rubber and Rubber-like Materials, Number 18-00.

C.1.3

Plastic materials may be used in sight and/or light openings and for gaskets, flexible connectors, scrapers, belts, belts with integrally molded cleats, rollers, bearings, and coverings for belts and rollers.

C.1.4

Plastic materials when used for the above specified applications shall comply with the applicable provisions of the 3-A Standards for Plastic Materials, Number 20-12.

C.1.5

Rubber and rubber-like materials and plastic materials having a product contact surface(s) shall be of such composition as to retain their surface and conformation characteristics when exposed to the conditions encoun-

¹The data for this series are contained in the following reference: AISI Steel Products Manual, Stainless & Heat Resisting Steels, December 1974, Table 2-1, pp. 18-19. Available from: American Iron & Steel Institute, 1000 16th Street, NW, Washington, DC 20036

²Alloy Casting Institute Division, Steel Founders' Society of America, 2061 Center Ridge Road, Rocky River, OH 44116.

tered in the environment of intended use and in cleaning and bactericidal treatment.

C.1.6

Cotton, linen, silk, or synthetic material may be used for flexible connectors. These materials shall be non shedding, non-toxic, relatively insoluble, easily cleanable, and shall not impart a flavor to the product.

C.1.7

Aluminum alloys conforming to the Aluminum Association³ designates 5052, 6061 and 6063 may be used as a dry product contact surface for dust covers, shields and parts having the same functional purpose. These shall be removed prior to mechanical cleaning.

C.1.8

Glass may be used in sight and/or light openings and shall be of a clear heat resistant type.

C.1.9

The final bond and residual adhesive, if used, of bonded rubber and rubber-like materials and bonded plastic materials shall be non-toxic.

C.2

Non-product contact surfaces shall be of corrosion-resistant materials or material that is rendered corrosion-resistant. If coated, the coating used shall adhere. Non-product contact surfaces shall be relatively non-absorbent, durable and cleanable. Parts removable for cleaning having both product contact and non-product contact surfaces shall not be painted.

D.

FABRICATION

D.1

All product contact surfaces shall have a finish at least as smooth as a No. 4 ground finish on stainless steel sheets and be free of imperfections such as pits, folds, and crevices in the final fabricated form. (See Appendix, Section F.)

D.2

Permanent joints in metallic product contact surfaces shall be continuously welded. Welded areas on product contact surfaces shall be at least as smooth as a No. 4 ground finish on stainless steel sheets free of imperfections such as pits, folds and crevices.

D.2.1

Intricate fabricated and/or machined parts shall be at least as smooth as a finish obtained with 80 grit silicon carbide.

D.3

Bonded gaskets and rubber or rubber-like and plastic materials that are a coating or covering shall be bonded in such a manner that the bond is continuous and mechanically sound and when exposed to the conditions encountered in the environment of intended use and in cleaning and bactericidal treatment, the rubber or rubber-like material or the plastic material does not separate from the base material.

D.4

Conveyors that are to be mechanically cleaned shall be designed so that all product contact surfaces and all appurtenances not removed during cleaning can be cleaned mechanically and inspected. Parts that must be removed for cleaning shall be readily removable and easily dismantled.

D.5

Product contact surfaces of conveyors not designed to be mechanically cleaned shall be easily accessible for cleaning, and inspection either when in an assembled position or when removed. Parts to be removed for cleaning shall be readily removable and easily dismantled.

D.5.1

Means shall be provided to enable access for dry cleaning. To facilitate dry cleaning, the construction shall be such that guides, guards, and covers can be removed and belt tension can be easily released, if necessary, to permit cleaning of the underside of the belt and/or conveyor.

D.6

Product contact surfaces intended for regular wet cleaning shall be self-draining except for normal clingage.

D.7

Belts

D.7.1

Metal belts having a product contact surface(s), shall be endless.

D.7.2

Non-metal belts having a product contact surface shall be made of or covered with a food grade rubber or rubber-like or plastic material. Belts made of an absorbent core material shall have edges sealed with the same material as is used for product contact surfaces.

D.7.2.1

Non-metal belts shall be endless.

D.7.3

To facilitate cleaning, the construction shall be such that belts, guides, guards, rollers, and all other parts be easily removable for cleaning and inspection.

D.8

Gaskets having a product contact surface shall be removable or bonded.

D.9

Gasket retaining grooves in product contact surfaces shall be no deeper than their width.

D.10

Radii. Internal angles of 135° or less on product contact surfaces shall have radii of not less than 1/4 inch, except that:

D.10.1

The radii in gasket retaining grooves except for those for standard 1/4 inch and smaller O-Rings, shall be not less than 1/8 inch.

D.10.2

The radii in grooves for standard 1/4 inch O-Rings shall be not less than 3/32 inch and for standard 1/8 inch O-Rings shall be not less than 1/32 inch.

³ Aluminum Association, 420 Lexington Avenue, New York, N.Y. 10017.

- D.11
There shall be no exposed threads on product contact surfaces.
- D.12
Coil springs having product contact surfaces shall have at least 3/32 inch openings between coils, including the ends when the spring is in a free position.
- D.13
Sight and light openings, when provided, shall be of such design and construction that the inner surfaces drain inwardly; and if the conveyor is designed for mechanical cleaning, the inner surface of the glass or plastic shall be relatively flush with the inner surface of the conveyor. The exterior flare shall be pitched so that liquids cannot accumulate. The glass or plastic shall be readily removable. The inside diameter of the opening shall be at least 3-3/4 inches.
- D.14
Bearings having a product contact surface shall be of non-lubricated type. Lubricated bearings, including the permanent sealed type, shall be located outside the product contact surface with at least 1 inch clearance between the bearing and any product contact surface. When a shaft passes through a product contact surface, the portion of the opening surrounding the shaft shall be protected to prevent the entrance of contaminants.
- D.15
The design and construction shall be such that extraneous materials cannot enter the conveyor. Covers, either removable or hinged, shall be provided for all openings into the conveyor except the inlet and outlet openings. Covers shall (1) make close contact with the openings (2) have downward flanges of at least 3/8 inch and (3) be pitched to an outside edge(s).
- D.16
Hinges shall not have any surface(s) in contact with the product and shall be readily cleanable. They shall not be of a continuous (piano) type.
- D.17
The edges of all openings into the conveyor shall extend upward or outward at least 1/2 inch. An exception to this requirement is made for a shaft opening. (See D.14)
- D.18
Flexible connectors having product contact surfaces shall have straight sides without corrugations and shall be readily cleanable.
- D.19
Supports. The means of supporting shall provide a clearance between all the parts of the conveyor and supporting member, with the exception of legs, of at least 6 inches. An exception is made to this minimum clearance for conveyors that convey product from equipment supported directly on a floor. Such conveyors shall be capable of being moved. Legs, if provided, shall be smooth, have no exposed threads and shall have rounded ends or be designed to permit sealing to the

floor or other mounting surface. Legs made of hollow stock shall be sealed. Conveyors that are portable may be equipped with casters. Casters shall be easily cleanable, durable and of a size that will permit easy movement of the conveyor.

- D.20
Guards required by a safety standard that will not permit accessibility for cleaning and inspection when in place shall be designed so that they can be removed without the use of tools.
- D.21
Non-product contact surfaces shall have a finish that can be readily cleaned and shall be relatively free of cracks and crevices. Surfaces to be coated shall be effectively prepared.

APPENDIX

- E.
STAINLESS STEEL MATERIALS Stainless steel conforming to the applicable composition ranges established by AISI for wrought products, or by ACI for cast products should be considered in compliance with requirements of Section C.1 herein. Where welding is involved, the carbon content of the stainless steel should not exceed 0.08 percent. The first reference cited in C.1 sets forth the chemical ranges and limits of acceptable stainless steel of the 300 series. Cast grades of stainless steel corresponding to types 303, 304, and 316 are designated CF-16F, CF-8, and CF-8M, respectively. These cast grades are covered by ASTM⁴ specifications A296-68 and A351-70.
- F.
PRODUCT CONTACT SURFACE FINISH Surface finish equivalent to 150 grit or better as obtained with silicon carbide, properly applied on stainless steel sheets is considered in compliance with the requirements of Section D.1 herein.
- G.
Supporting members and braces are considered parts of the building structure, i.e. walls, floors, ceiling.

H. RECOMMENDATIONS FOR CLEANING MECHANICAL CONVEYORS

- H.1
Dry Cleaning Program:
- H.1.1
Dismantle and where necessary thoroughly vacuum or dry brush clean all product contact surfaces of the conveyor. Reassemble as soon as finished and keep all parts dry.
- H.1.2
Flexible connectors at the inlet and outlets of the conveyor should be thoroughly cleaned, following procedures recommended for the conveyor. Connectors should be closely examined for holes, cracks or other damage. (To facilitate removal for cleaning, use of easily removable fastening devices is recommended.)

⁴ Available from American Society for Testing and Materials, 1916 Race Street, Philadelphia, PA. 19103

H.1.3

Thoroughly vacuum or dry brush clean all external parts of the conveyor, including the conveyor support frame and drive mechanism.

H.2

Wet Cleaning Program:

H.2.1

Completely dismantle, remove all loose dry product, then rinse all parts with clear water and follow with a thorough hand brushing of all parts using a general purpose cleanser. Rinse thoroughly to remove all cleaning solution or soil. It is recommended that hot water (170°F or 77°C or above) be used for rinsing to promote drying. Allow all parts to air dry completely prior to reassembly. After cleaning, drying and reassembly, all openings should be protected against recontamination. Wet washing should be done only when necessary.

H.3

General:

H.3.1

Vacuum cleaning is preferred to brush cleaning or cleaning with air under pressure as it decreases dust drift to other areas of the plant.

H.3.2

Brushes or vacuum cleaner fittings used for cleaning product contact surfaces should not be used for cleaning non-product contact surfaces or for other uses which might result in contamination. Such tools should be made of materials that can be cleaned and sanitized and should not have wooden parts nor be of mild steel or other iron products that will rust. Such brushes and special fittings should be stored in a separate enclosed cabinet when not in use. For protection and house-keeping considerations, such cabinets should be of non-wood construction and should have open mesh metal or plastic shelving.

These standards shall become effective September 10, 1983.

CARDINAL BASEBALL IAMFES

ONLY ONE SCHEDULED GAME

Sunday, August 7, 1983 ----- 1:15 P.M. -- St. Louis Cardinals vs. Phillies
(Walk to Stadium from Marriott Pavilion Hotel)

Mail to: Vernon R. Cupps

Milk Control Service
St. Louis Health Division
P.O. Box 14702
St. Louis, Missouri 63178
Phone: 314-658-1112

Name _____

Address _____

_____ Number of reserved seats @ \$6.00 per seat. \$_____ enclosed.

(Tickets will not be mailed. They will be available at Registration Desk.)

Supplement Number 2 to 3-A Sanitary Standards For Fittings Used In Milk and Milk Products Equipment And Used On Sanitary Lines Conducting Milk and Milk Products,

Number 08-17B

*Formulated by
International Association of Milk, Food and Environmental Sanitarians
United States Public Health Service
The Dairy Industry Committee*

This supplement adds the criteria for rupture discs to Section E. Special considerations of the 3-A Sanitary Standards for Fittings Used on Milk and Milk Products Equipment and Used on Sanitary Lines Conducting Milk and Milk Products, Number 08-17 (Reference 3-A Drawing No. 3A-100-43)

Change C.1.5 to read:

C.1.5

Plastic materials may be used for covering the interior surface of the bonnet of diaphragm-type valves, gaskets, (either bonded or removable), valve plugs, valve body liners, diaphragms, poppets of boot seal valves, boot seals, O Rings, seals, girdles for rupture disc assembly and parts with the same functional properties.

E.11

Rupture discs (reference 3-A Drawing Number 3A-100-43) shall comply with the applicable provisions of this standard and the following:

E.11.1

The rupture disc assembly shall consist of a disc holder, top section (if used), seal, a girdle and means for rupturing the seal.

E.11.2

Product contact surfaces shall be of materials conforming to the criteria in subsections C.1, C.1.4, and C.1.6.

E.11.3

The disc holder shall be of materials conforming to the criteria in subsection C.1.

E.11.4

Product contact surfaces shall be readily accessible for cleaning and inspection, either in an assembled position

or when removed. Removable parts shall be readily disassembled.

E.11.5

Internal angles of 135° or less on product contact surfaces shall have minimum radii of 1/4 inch except those where for space or functional reasons it is impossible to have a radius of 1/4 inch. When the radius is less than 1/4 inch, the product contact surface of this angle, must be readily accessible for cleaning and inspection. In no case shall the radius be less than 1/32 inch.

E.11.6

There shall be no threads on product contact surfaces.

E.11.7

If a perforated disc top section is used, the perforations shall not be less than 1/4 inch in diameter.

Add to APPENDIX

I.

When rupture discs are used, they should be located to conform with D.18 of 3-A Sanitary Standards for Storage Tanks for Milk and Milk Products, No. 01-06 and D.11 of 3-A Sanitary Standards for Silo-Type Storage Tanks for Milk and Milk Products, No. 22-03, or be properly filtered.

Change I. to J.

DISC HOLDER
SANITARY FITTING
OUTLET FLG.

TOP SECTION

SEAL
w/ ALARM
STRIP

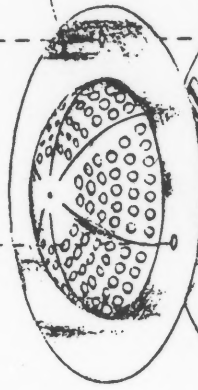
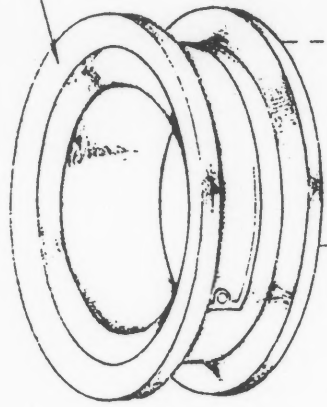

CLAMP

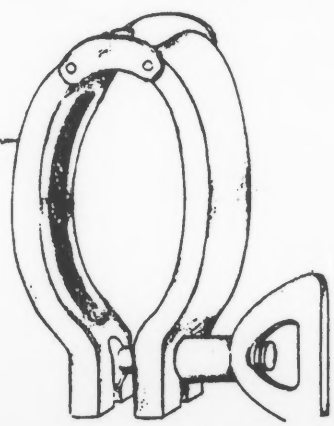

-GIRDLE

DISC HOLDER
SANITARY FITTING INLET
FLG. W/ KNIFE BLADE
ASSEMBLY

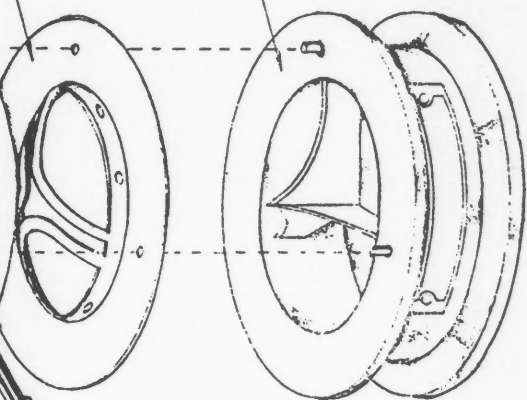

ALARM STRIP
CONNECTOR

RUPTURE DISC ASSEMBLY AND ALARM SYSTEM

How Assessment Services can help you.

At the National Sanitation Foundation, the Assessment Services group evaluates products, systems, and services not covered by our Listing and Certification Services. We undertake special testing, research, demonstration projects, and studies for industry, service companies, government, and individuals with health and environmental concerns. The objectivity and integrity associated with NSF make Assessment Services unique. We provide specialized physical, chemical, and microbiological testing, including field testing by trained professionals. It could be just the help you need! Some examples:

Disposable containers
Microbiological testing and plant inspection services are provided to 10 manufacturers of disposable

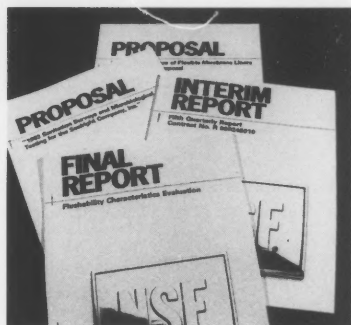

containers through the Single Service Institute. The routine testing required by state regulatory authorities and voluntary plant inspections

Find Out What Assessment Services Can Do For You!
Write or Phone for Free Information:
• Assessment Services Brochure
• NSF Facts Brochure

are carried out in accordance with US Food and Drug Administration standards.

Water Disinfection Systems
A study of cruise vessel drinking water disinfection systems was performed for the Centers for Disease Control to assist them in protecting passengers' health.

Water Treatment
Under a contract with the US Environmental Protection Agency, we are studying the costs, maintenance requirements, and effectiveness of various small central systems

and point-of-use units to reduce fluoride levels in drinking water.

Hazardous Wastes

In another project, the solidified product from a hazardous waste chemical treatment and solidification process was rigorously tested for leaching of hazardous or toxic constituents. Test results were provided to the state regulatory agency reviewing the process.

Wastewater Treatment

Under contract with manufacturers, new products have been tested and evaluated for their effects on various onsite wastewater treatment systems.

Please contact Assessment Services for more information, or to discuss your needs in detail. Inquiries from anywhere in the world are welcome.



National Sanitation Foundation

Offices and laboratories, P.O. Box 1468, Ann Arbor, MI 48106 Phone: (313) 769-8010

AFFILIATE NEWSLETTER . . .

KAMFES Meeting Highlights

The 1983 Educational Conference for Fieldmen and Sanitarians sponsored by the Kentucky Association for Milk, Food and Environmental Sanitarians, Inc., was held February 15 & 16, 1983, at the Executive Inn, Louisville, KY.

Approximately 200 persons attended the Conference.

The following awards were presented during the Award's Luncheon:

Outstanding Sanitarian Award - Plaque presented by George Jones, Economics Laboratory - Klenszade Products, St. Paul Minnesota to:

Charles Belcher, Milk Control Branch

Dairy Industry Award - Plaque presented by Roger McDonald, Monarch Chemical Division - H.B. Fuller Co., Minneapolis, Minnesota to:

Barry Kinslow, Dairymen Inc.

Service Award - not presented due to lack of a nominee.

Achievement Award - not presented due to lack of a nominee.

Life Memberships presented by Dale Marcum, Secretary - Treasurer to:

Tom Batsche, Cincinnati City Health Dept.
J. Paul Browning, Harrison County Health Dept.
Glenn Cross, Dairy Products Assoc. of KY
James Erwin, Calloway County Health Dept.
Edward Napier, Kraft Dairy Group - Sealtest

A Past - President Plaque was presented to Dr. Bruce Langlois by the 1981 Past - President, Leon Townsend. The meeting was then turned over to the new President, Betty Kelly.

The door prize donated by the Executive Inn was drawn by Babs Wilson and won by William Murphy, Food and Sanitation Branch. The door prize was a free weekend including expenses at the Executive Inn.



Barry Kinslow



Charles Belcher



Seated from left to right: Berford Turner; Dale Marcum (Secretary-Treasurer); Betty Kelly (President); David Atkinson; John Bruce Mattingly (President-Elect); standing from left to right: Tim Vorbeck; William Crist; Eugene Catron; Joseph Schureck; John Draper (Vice-President); Bruce Langlois (Past-President); Roger Barber; William Montgomery; Ed Cecil; and James McCammon).

Florida Association Holds Conference

The Florida Association of Milk, Food and Environmental Sanitarians held their Annual Educational Conference March 8 and 9, 1983 at the Quality Inn in Cypress Gardens, FL. The meeting was exceptionally successful with 105 registered for the meeting sessions and 81 attending the Annual Banquet on March 8. Fourteen papers were presented at the four scientific sessions covering topics of interest to the entire group.

At the banquet, the Past President's Certificate was presented to William Isbell and the second Scholarship Award of \$500 was given to Maria Rodriguez, a student of the Food Science and Human Nutrition Department at the University of Florida.

The newly elected officers and Board of Directors are:

President: Dr. Ken Smith

President Elect: James Strange

Board of Directors:

Jane Foos

Richard Holtsclaw

David Fry

Richard Jolley

Dan Rader

Calendar

June 1-3, 1983--"ROLES OF CEREALS AND LEGUMES IN THE FOOD SUPPLY" three day symposium sponsored by the Nutritional Sciences Council of Iowa State University. For more information contact: Dr. J. Dupont, Dept. of Food and Nutrition, Iowa State University, Ames, IA 50011.

June 8, 1983-NEBRASKA DAIRY INDUSTRIES ASSOCIATION ANNUAL SPRING DAIRY OUTING, Beemer, NE. For more information contact: T. A. Evans, Executive Secretary, 134 Filley Hall, East Campus, UN-L, Lincoln, NE 68583.

June 13-14, 1983-CONFERENCES ON THE HUMAN-ANIMAL BOND, University of Minnesota. Contact: Center to Study Human-Animal Relationships and Environment 1-117 Health Sciences Unit A 515 Delaware St. S.E., Minneapolis, MN 55455.

June 14-15, 1983---TEXAS ASSOCIATION OF MILK, FOOD & ENVIRONMENTAL SANITARIANS, INC. ANNUAL MEETING. Sheraton-Safari Inn, Grand Prairie, TX. For more information contact: Clair Gothard, 1115 North MacGregor, Houston, TX 77030.

June 17-18, 1983-CONFERENCES ON THE HUMAN-ANIMAL BOND, University of California, Irvine. Contact: California College of Medicine A121 Medical Sciences I, Irvine, CA 92717.

July 3-8, 1983---67TH ANNUAL SESSION OF THE INTERNATIONAL DAIRY FEDERATION, Oslo, Norway. For further information, contact Harold Wainess, Secretary U.S. National Committee of the IDF (USNAC), 464 Central Avenue, Northfield, IL 60093, 312-446-2402.

July 9-14, 1983-ANNUAL EDUCATION CONFERENCE, National Environmental Health Association, Holiday Inn Scope, Norfolk, VA. Contact: Leon F. Vinci, Director of Health, City of Middletown, Middletown, CT 06457-1300.

July 16-23, MICROBIOLOGY WORKSHOP, Kansas State Univ. For more information contact: Dr. Daniel Fung, Call Hall, KSU, Manhattan, KS 66506, 913-532-5654.

August 1-5, 1983--"BIOTECHNOLOGY: MICROBIAL PRINCIPLES AND PROCESSES FOR FUELS, CHEMICALS AND INGREDIENTS" Massachusetts Institute of Technology, Cambridge, MA 02139. Contact: Director of Summer Session, MIT, Room E 19-356, Cambridge, MA 02139.

Aug. 7-11, 1983---70th ANNUAL MEETING OF IAMFES. Marriott Pavilion, St. Louis, MO. For more information contact: Kathy R. Hathaway, IAMFES, PO Box 701, Ames, IA 50010, 515-232-6699.

Aug. 7-11, 1983---23rd ANNUAL MEETING, THE HOSPITAL, INSTITUTION, AND EDUCATIONAL FOOD SERVICE SOCIETY. Fairmont Hotel, New Orleans, LA. HIEFSS Expo '83 will be open on August 9 and 10. For more information contact: Carolyn Isch, Assistant Executive Director, HIEFSS, 4410 West Roosevelt Road, Hillside, IL 60162, 312 449-2770.

Aug. 14-19, 1983---5th WORLD CONFERENCE ON ANIMAL PRODUCTION, Nihon Toshi Center, Tokyo, Japan. For more information contact: The 5th WCAP Conference Secretariat, c/o National Institute of Animal Industry, Tsukuba Norindanchi, PO Box 5, Ibaraki 305, Japan.

Sept. 7-9---SYMPOSIUM ON LACTIC ACID BACTERIA IN FOODS: GENETICS, METABOLISM AND APPLICATIONS. Wageningen, The Netherlands. Organized by The Netherlands Society for Microbiology. For more information contact: Dr. P. M. Klapwijk, Unilever Research Laboratory, P. O. Box 114, 3130 AC Vlaarding, The Netherlands.

Sept. 14-15, 1983 NEBRASKA DAIRY INDUSTRIES ASSOCIATION 29TH ANNUAL CONVENTION, Bellevue, NE. For more information contact: T. A. Evans, Executive Secretary, 134 Filley Hall, East Campus, UN-L, Lincoln, NE 68583.

Sept. 18-23---SIXTH WORLD CONGRESS OF FOOD SCIENCE & TECHNOLOGY, Dublin, Ireland. For more information contact: Sixth World Congress of Food Science and Technol-

ogy, Congresses & Exhibition Ltd. 44, Northumberland Rd., Dublin, 4, Ireland.

Sept. 20-22---NEW YORK STATE ASSOCIATION OF MILK AND FOOD SANITATION ANNUAL MEETING. Hotel Syracuse, Syracuse, NY. For more information contact: David Bandler, Stocking Hall, Cornell University, Ithaca, NY 14853.

Oct. 22-26---FOOD AND DAIRY EXPO-83, McCormick Place, Chicago, IL. For more information contact: Dairy and Food Industries Supply Association, 6245 Executive Blvd., Rockville, MD 20852, 301-984-1444.

October 26-28---WORKSHOP IN FOOD FLAVOR: A HANDS ON COURSE IN FLAVOR DEVELOPMENT, MANUFACTURE, AND USE. For more information contact: G. Reineccius, Department of Food Science and Nutrition, Univ. of MN, St. Paul, MN 55108.

Nov. 2-4, 1983 9TH ANNUAL FOOD MICROBIOLOGY RESEARCH CONFERENCE, Chicago, IL. For more information contact: Dr. J. M. Goepfert Canada Packers, Ltd., 2211 St. Clair Avenue West, Toronto, CN M6N 1K4.

Nov. 22-24, 1984---14th ANNUAL SYMPOSIUM ON THE ANALYTICAL CHEMISTRY OF POLLUTANTS, 3rd International Congress on Analytical Techniques on Environmental Chemistry-Expoquimia, Barcelona Spain. For more information write: Av. Reina Ma. Christina Palacio No. 1, Barcelona-4 Spain.

1984

August 3-9, 1984---IAMFES ANNUAL MEETING, Edmonton, Alberta, Canada.

Nov. 22-24, 1984---14th ANNUAL SYMPOSIUM ON THE ANALYTICAL CHEMISTRY OF POLLUTANTS, 3rd International Congress on Analytical Techniques on Environmental Chemistry-Expoquimia, Barcelona Spain. For more information write: Av. Reina Ma. Christina Palacio No. 1, Barcelona-4 Spain.

Dairy and Food Sanitation – Instructions for Authors

Nature of the Magazine

Dairy and Food Sanitation is a monthly publication of the International Association of Milk, Food and Environmental Sanitarians, Inc. (IAMFES). It is targeted for persons working in industry, regulatory agencies, or teaching in milk, food and environmental protection.

The major emphases include: 1) practical articles in milk, food and environmental protection, 2) new product information, 3) news of activities and individuals in the field, 4) news of IAMFES affiliate groups and their members, 5) 3-A and E-3A Sanitary Standards, amendments, and lists of symbol holders, 6) excerpts of articles and information from other publications of interest to the readership.

Prospective authors who have questions about the suitability of their material for publication should contact the editor.

Submitting Articles and Information

All manuscripts and letters should be submitted in duplicate to the editor, Kathy Hathaway, IAMFES, Box 701, Ames, Iowa 50010. Revised manuscripts should also be submitted in duplicate to the editor.

Subjects suitable for inclusion in the "News and Events" section include: meeting announcements, short courses, notices of position changes and promotions, announcements of new products or advancements in the field which are of interest to the readership, death notices of members of the Association.

Correspondence regarding membership in IAMFES, subscriptions, and advertising should be sent to the above address, also.

Manuscripts are accepted for publication, subject to editorial review. Most articles are reviewed by two members of the editorial board or by other specialists when in the opinion of the editor the paper is outside of the specializations represented by editorial board members. After review, a manuscript is generally returned to the author for revision in accordance with reviewer's suggestions. Authors can hasten publication of their articles by revising and returning them promptly. With authors' cooperation articles are usually published within three to six months after they are received and may appear sooner.

The author is notified when a manuscript is received and also when it is sent to the printer for preparation of proofs.

Membership in IAMFES is not a prerequisite for acceptance of an article.

Articles, when accepted, become the copyright property of *Dairy and Food Sanitation* and its sponsoring association. Reprinting of any material from *Dairy and Food Sanitation* or republishing of any papers or portions of them is prohibited unless permission to do so is granted by the editor.

Reprints

Reprints of an article may be ordered by the author when proofs are returned. An order form for this purpose is attached to the proofs when they are returned to the author. Reprints may be ordered with or without covers, in multiples of 100. Reprint costs vary according to the number of printed pages in the article. Reprints cannot be provided free of charge.

Reprints may also be ordered after a paper has been published. The IAMFES office can supply reprints of any paper published in *Dairy and Food Sanitation*. Arrangements to obtain such reprints should be made with the editor.

Types of Articles

Dairy and Food Sanitation readers include persons working as sanitarians, fieldmen or quality control persons for industry, regulatory agencies, or in education. *Dairy and Food Sanitation* serves this readership by publishing a variety of papers of interest and usefulness to these persons. The following types of articles and information are acceptable for publication in *Dairy and Food Sanitation*.

General Interest

Dairy and Food Sanitation regularly publishes non-technical articles as a service to those readers who are not involved in the technical aspects of milk, food and environmental protection. These articles deal with such topics as the organization and application of a milk or food control program or quality control program, ways of solving a particular problem in the field, organization of a regulatory agency or department, organization and application of an educational program, management skills, use of visual aids, and similar subjects. Often talks and presentations given at meetings of affiliate groups and other gatherings can be modified sufficiently to make them appropriate for publication. Authors planning to prepare general interest nontechnical articles are invited to correspond with the editor if they have questions about the suitability of their material.

Letters to the Editor

Readers are invited to submit letters to the editor to express their opinion on articles published in *Dairy and*

Food Sanitation, or on other matters of concern or interest to the entire readership. The letter to the editor may also be used to report limited observations made in the field or in a laboratory which cannot be published in another form. A letter to the editor must be signed by its author.

Book Reviews

Authors and publishers of books in the fields covered by *Dairy and Food Sanitation* are invited to submit their books to the editor. Books will then be reviewed by a specialist in the field and a review will be published in an issue of *Dairy and Food Sanitation*.

Preparation of Articles

All manuscripts should be typed, double-spaced, on 8½ by 11 inch bond paper. Side margins should be one inch wide and pages should not be stapled together.

The editor assumes that the senior author has received proper clearance from his/her organization for publication of the article. An author should be aware of procedures for approval within his/her organization.

A manuscript should be read by someone other than the author before it is submitted. This will help to eliminate errors and to clarify statements, all of which speeds publication of the article.

The title of the article should appear at the top of the first page. It should be as brief as possible, contain no abbreviations.

Names of authors and their professions should follow under the title. If an author has changed location since the article was completed, his new address should be given in a footnote.

An abstract should be included at the beginning of the article. It should be brief, factual, not exceeding 200 words. The abstract should give an overview of the article and should be understandable without reading the rest of the paper, as abstracts are reprinted by abstracting journals and are distributed beyond the readership of *Dairy and Food Sanitation*, to persons who may not have access to the entire article. Therefore, abstracts should be complete but concise.

The remainder of the article should begin with an introductory statement, then should be subdivided into appropriate sections, each with a subheading descriptive of the material in that section. Review papers, by their nature, include numerous references. Citation of references in the text and listing of references at the end of the paper should be done as mentioned at the end of these instructions.

Illustrations, Photographs, Figures

Wherever possible, submission of photos, graphics, or drawings to illustrate the article will help the article. The nature of *Dairy and Food Sanitation* allows liberal use of such illustrations, and interesting photographs or drawings often increase the number of persons who are attracted to and read the article.

Photographs which are submitted should have sharp images, with good contrast and a minimum of distracting items.

Drawings, diagrams, charts and similar material should be submitted in India ink on 8½ by 11 inch paper, either white or light blue. Don't use paper with green, red, or yellow lines since they will appear in the final copy. A lettering guide should be used to prepare letters on figures. Titles for figures should be submitted on separate sheets rather than on the figures. Arabic numbers should be used for numbering. Glossy prints of figures are suitable for use and should be at least 4 by 5 inches in size.

Tables should be submitted on separate sheets of 8½ by 11 inch paper. They should not be included in the text of the paper. Use Arabic numbers for numbering of tables. Titles should be brief but descriptive. Headings and subheadings should be concise with columns or rows of data centered below them. Use only horizontal lines to separate sections of tables. When possible, use figures instead of tables as the latter are more costly to prepare for publication.

Examples of Proper Bibliographic Citations:

Paper in a journal

Alderman, G. G. and E. H. Marth. 1974. Experimental production of aflatoxin in citrus juice and peel. *J. Milk Food Technol.* 37:308-313.

Paper in a book

Marth E. H. 1974. Fermentations. pp. 771-882. In B. H. Webb, A. H. Johnson, and J. A. Alford (eds.) *Fundamentals of dairy chemistry* (2nd ed.), Avi Publishing Co., Westport, CT.

Book

Fennema, O. R., W. D. Powrie, and E. H. Marth. 1973. *Low-temperature preservation of foods and living matter*. Marcel Dekker, Inc., New York. 598 p.

Patent

Hussong, R. V., E. H. Marth, and D. G. Vakaleris. 1964. *Manufacture of cottage cheese*. U.S. Pat. 3,117,870. Jan. 14.

St. Louis — in the heart of it all

You are invited to attend the 70th Annual Meeting of IAMFES, August 7-11, 1983 at the Marriott Pavillion in beautiful St. Louis, MO. Educational meetings, interminglings with fellow professionals and entertainment has been planned for this yearly event. You'll also enjoy the Ralston Purina Farm outing and dinner. Spouse's entertainment is once again an outstanding attraction. Don't miss it!



ADVANCED REGISTRATION FORM for the 70th IAMFES ANNUAL MEETING August 7-11, 1983, St. Louis, MO

Mail Meeting Registration Today To:

Vernon R. Cupps
Milk Control Service
St. Louis Health Division
PO Box 14702
St. Louis, MO 63178
314-658-1112

Please check where applicable:

- | | |
|---|---|
| <input type="checkbox"/> Affiliate Delegate | <input type="checkbox"/> Speaker |
| <input type="checkbox"/> Affiliate Member | <input type="checkbox"/> 30 year Member |
| <input type="checkbox"/> IAMFES Member | <input type="checkbox"/> 50 year Member |
| <input type="checkbox"/> Past President | <input type="checkbox"/> Non-Member |
| <input type="checkbox"/> Executive Board | |

ADVANCE REGISTER NOW BEFORE JULY 1, 1983 ... AND SAVE
(refundable prior to June 30 if you don't attend)

Make Checks Payable to ... IAMFES MEETING FUND

Registration	ADVANCE REGISTRATION				REGISTRATION AT DOOR			
	Member	Spouse of Member	Student	Non Member	Member	Spouse of Member	Student	Non Member
	<input type="checkbox"/> \$30	<input type="checkbox"/> \$10	Free	<input type="checkbox"/> \$40	<input type="checkbox"/> \$35	<input type="checkbox"/> \$12	Free	<input type="checkbox"/> \$45
Ralston Purina Farm Outing and Dinner	<input type="checkbox"/> \$15	<input type="checkbox"/> \$15	<input type="checkbox"/> \$15	<input type="checkbox"/> \$15	<input type="checkbox"/> \$17	<input type="checkbox"/> \$17	<input type="checkbox"/> \$17	<input type="checkbox"/> \$17
Banquet & Cocktail hr.	<input type="checkbox"/> \$15	<input type="checkbox"/> \$15	<input type="checkbox"/> \$15	<input type="checkbox"/> \$15	<input type="checkbox"/> \$17	<input type="checkbox"/> \$17	<input type="checkbox"/> \$17	<input type="checkbox"/> \$17

Name _____

Employer _____

Address _____

City _____ State _____ Zip _____

MAIL this bottom section to: Marriott Pavillion, One Broadway, St. Louis, MO 63102, 314-421-1776
IAMFES 70th Annual Meeting August 7-11, 1983

Arrival Date & time _____ Departure Date _____

Name _____ Address _____

City _____ State _____ Zip _____

*Arrangements have been made for a flat rate of \$48 per room with a maximum of 4 people to the room. These rooms will have 2 double beds. \$5.00 parking charge per day, includes in and out privileges.

1982 DAIRY AND FOOD SANITATION BACK ISSUES ARE NOW AVAILABLE

✓ Check those months issues you desire plus \$5.50 for each issue requested.

 JANUARY 1982

The Why and How of Proper Milk Sampling by the Milk Hauler
 Reading Scientific Literature: Is it Worth Your Time and Effort?
 Quality and Labeling of Cottage and Ricotta Cheese
 Plumbing Hazards in the Food Industry
 Microbiology in Food Processing
 NCTR: Gazing at the Scars That Our Concoctions May Leave Behind

 FEBRUARY 1982

1 Alert Cook + Bad Can of Mushrooms = A Total Recall
 Purifying Food Via Irradiation
 The NSF Seal-Its Formulation and Uses
 Microbial Injury Reviewed for the Sanitarian
 Maintaining Your USPH Rating

 MARCH 1982

Fundamentals of Cleaning and Sanitizing Multiuse Utensils and Food Equipment Surfaces
 Training Programs: They Need Not Be Boring
 Quality of Milk and Patterns of Consumption by Children in Connecticut Schools and Camps
 Gumshoeing the FD&C Act at the Grass Roots Level
 Test Dip as a Component of Coliform Mastitis Control

 APRIL 1982

A New Method of Hydrogen Peroxide Application "Nebulization"
 Proper Pesticide Applications in Food Establishments
 Sanitation in the Processing and Packaging of Raw Cider
 Maintenance and Measurements of Product Temperature in Food Service

 MAY 1982

Quality Assurance Through the Preliminary Incubation Count
 A Common-Source Outbreak of Salmonellosis at a Milwaukee Hotel
 The Foodborne Illness Equation
 Procedures to Investigate Foodborne Illness

 JUNE 1982

Making the Most of Scientific Meetings
 The Food Service Manager Training and Certification Program
 Quality of Sour Cream and Non-Butterfat Sour Dressing

 JULY 1982

A Marketing Perspective of Dairy Product Quality
 Checking Electronic Somatic Cell Count Machines
 The Use of the DHI-SCC Program to Select cows for Bacteriological Milk Culture and Subsequent Treatment, Early Dry-off or Culling
 Milk Memos

 AUGUST 1982

Rancidity: An Increasingly Common Milk Flavor Problem
 Sodium in Foods
 Assessment of Raw Milk Quality in New York State
 United States Food Laws and Regulations: An Overview

 SEPTEMBER 1982

Formulating Microbiological Culture Media-A Careful Balance Between Science and Art
 Quality Assurance of Microbiological Culture Media
 Minimizing Predicted Bacterial Growth in a Commissary Foodservice System Utilizing Quality Assurance Tools
 Measurement and Reduction of Iodine in Milk

 OCTOBER 1982

Septics and Shigellosis Linked in Marion County
 How to Prevent Antibiotic Contamination of Milk and Meat
 A Guide to Sampling
 Fruit Content of Breakfast Cereals

 NOVEMBER 1982

Quality of Crackers
 Warehouse Organization and Current Good Manufacturing Practices (CGMP's)
 Dairy Farming in the U.S. Virgin Islands - A Talk with the Island Dairyman
 A Quality Control Program Recommendation for UHT Processing and Aseptic Packing of Milk and Milk By Products

 DECEMBER 1982

Safe Storage of Small Amounts of Grains, Edible Seeds and Processed Foods
 Regulating a Dairy Plant in the U.S. Virgin Islands
 Antibiotic Detection Programs

Check those you need plus \$5.50 for each issue ordered and mailly today to:

IAMFES-Back Issues 1982
 PO Box 701
 Ames, IA 50010

OR USE you Master Card or Visa
 circle appropriate card

Card Number _____
 Expiration Date _____
 Your Signature _____

Orders filled as received.

We pay postage

NAME _____

ADDRESS _____

CITY _____

STATE _____ ZIP _____

Detect virtually all antibiotics. How co-ops keep contaminated milk on the farm.

"Penicillin losing punch in mastitis control," headlines a recent article. Producers are turning to other antibiotic materials.

That complicates monitoring. But not for leading dairy co-ops that supply Delvotest® P to their members for on-the-farm use.

Delvotest P detects virtually all growth inhibitors. It's sensitive to residues as minute as 0.005 IU/ml. And it has these advantages:

- Simple to use, requires no special training
- Needs only an inexpensive heat source
- Low cost per test
- Yields easily interpreted and conclusive readings
- No waste, even with one sampling

If you're a milk processor, let us send you information on how



your farmers can set up their own on-the-farm milk sampling tests.

Call or write:



GB Fermentation Industries Inc.

P.O. Box 241068
Charlotte, NC 28224
(704) 527-9000

2055 Bishop Street
Montreal, Quebec, Canada H3G 2E8
(514) 282-0161

Distributor inquiries invited.



MEETING ANNOUNCEMENT

Here Ye! Here Ye! Make plans now to "Meet Us in St. Louie, Louie - August 7-11, 1983." The occasion is the 70th Annual Meeting of the International Association of Milk, Food and Environmental Sanitarians, to be held in downtown St. Louis, Missouri at the luxurious Marriott Pavillion Hotel, One Broadway.

Look at this Winning Lineup!

Sunday August 7 - Wine and Cheese "Early Bird" Reception

Monday August 8 - Special Activities to be centered on the 1982 World's Champion St. Louis Cardinals Baseball Team

Tuesday August 9 - Tour of the famous Ralston Purina Research Farm at Gray Summit, Missouri, PLUS Family Style Meal and Entertainment

Wednesday August 10 - Awards Banquet and Entertainment

Make your plans NOW to see us in St. Louis, the Place to be in '83.

August 7-11, 1983

JFP Abstracts

Abstracts of papers in the June Journal of Food Protection

To receive the Journal of Food Protection in its entirety each month call 515-232-6699, ext. A.

Fate of Mycotoxins During Processing of Foodstuffs II - Deoxynivalenol (Vomitoxin) During Making of Egyptian Bread, A. A. El-Banna, P.-Y. Lau and P. M. Scott, Food Research Division, Health Protection Branch, Health and Welfare Canada, Ottawa, Ontario, Canada K1A 0L2

J. Food Prot. 46:484-486

Four batches of Egyptian bread were prepared using flour spiked with deoxynivalenol (DON) at a level of 2 µg/g in one batch and naturally contaminated flour (3.3 µg/g of DON) in the remainder. These breads, as well as the corresponding flour and fermented dough, were analyzed to follow the fate of DON during processing. Gas liquid chromatography (GLC) with electron capture (EC) detection was used for determination of DON and the results from two experiments were confirmed by GLC-mass spectrometric single ion monitoring [MS (SIM)]. Neither preparation of fermented dough nor the baking process (350°C for 2 min) affected the amount of DON in either spiked flour or naturally contaminated flour.

Critical Factors for Thermal Processing of Institutional Pouches, Maurice R. Berry, Jr. and Andrew L. Kohnhorst, Food Engineering Branch, Division of Food Technology, Food and Drug Administration, U.S. Department of Health and Human Services, 1090 Tusculum Avenue, Cincinnati, Ohio 45226

J. Food Prot. 46:487-489

Institutional-sized pouches filled with whole kernel corn in brine and condensed cream of celery soup were heated in a still retort. The sterilization values (F_0) and heat penetration parameters (j , f_h , f_2) were determined from temperature/time data as a function of the residual air in the horizontal pouches, pouch thickness, product fill, and circulation of the heating water. The F_0 value for the soup was reduced from 11.5 to 2.5 min as the residual air in the pouch was increased to 250 ml. The f_h value nearly doubled as a result of the insulating effect of the air layer at the upper surface of the pouch. Eliminating the circulation of the heating water between the pouch layers increased the critical dimension for heat transfer and reduced the F_0 for the soup to 0.6 min, an unacceptable value.

Reliability and Analyst Performance Limits for the Field and Single Strip direct Microscopic Somatic Cell Count Procedure, James E. Leslie, Jerald E. Barnett, Helen K. Bachelor, James T. Peeler and James W. Messer, Division of Microbiology Food and Drug Administration, 1090 Tusculum Avenue, Cincinnati, Ohio 45226

J. Food Prot. 46:490-492

The means and total components of variance were compared for the field and single strip direct microscopic somatic cell count (DMSCC) procedures. The field count procedure averaged 12 - 28% higher than the single strip count procedure in the 300,000

to 1,200,000 DMSCC/ml range. The sum of the components of variance in logarithm units for the field procedure was 0.01058 (1485 degrees of freedom) with a coefficient of variation of 24%, whereas the sum for the single strip procedure was 0.00834 (2834 degrees of freedom) with a coefficient of variation of 21%. This study demonstrates that the single strip procedure yields more reliable and less variable results than does the field procedure.

Enteric Bacterial and Viral Pathogens and Indicator Bacteria in Hard Shell Clams, Douglas A. Wait, Cameron Ray Hackney, Robert J. Carrick, G. Lovelace and Mark D. Sobsey, Department of Environmental Sciences and Engineering, School of Public Health, University of North Carolina, Chapel Hill, North Carolina 27514 and Department of Food Sciences, North Carolina State University, Raleigh, North Carolina

J. Food Prot. 46:493-496

Enteric bacteria and virus levels were determined in hard shell clams, *Mercenaria mercenaria*, harvested from areas open or closed for commercial shellfishing on the basis of total coliform levels in water. Four pairs of open and closed stations were sampled seasonally over a 1-year period. Enteric viruses were isolated from 3 of 13 100-g clam samples from open beds and 6 of 15 samples from closed beds. *Salmonella* was found in 1 of 15 samples from closed areas, but not in any samples from open areas. No *Shigella* or *Yersinia* were isolated from clams taken from either open or closed beds. Levels of *Vibrio parahaemolyticus*, an indigenous estuarine microorganism, were similar in clams from open and closed areas. No statistically significant difference was found in the occurrence of enteric viruses in clams from open and closed areas. Product-moment correlations between concentrations of enteric viruses and bacteria in clams or water demonstrated no statistically significant correlations between virus concentrations in clams and total coliforms or fecal coliforms in water or total coliforms, fecal coliforms, fecal streptococci or aerobic plate counts in clams.

Inhibition of Growth of Spoilage Microorganisms by *Streptococcus thermophilus* and *Lactobacillus acidophilus* in Cow, Buffalo and Goat Milk, Jasjit Singh, Yemen Dairy & Juice Industries Ltd., P.O. Box 3337, Hodeidah, Yemen Arab Republic

J. Food Prot. 46:497-498

Comparison of the inhibitory activity of pure and mixed cultures of *Streptococcus thermophilus* and *Lactobacillus acidophilus* against spoilage microorganisms, i.e., *Escherichia coli*, *Pseudomonas fragi*, *Micrococcus flavus* and *Staphylococcus aureus*, was done using cow, buffalo and goat milk. No antibacterial activity of *S. thermophilus* culture filtrate was observed against any of the spoilage microorganisms tested, irrespective of the type of milk and period of incubation. However, filtrates from *L. acidophilus* and mixed cultures of *S. thermophilus* and *L. acidophilus* exhibited significant inhibition of all test microorganisms. The inhibitory activity of lactic cultures was more evident in buffalo milk than cow or goat milk.

Potassium Sorbate and Recovery of Pectinolytic Psychrotrophs from Vacuum-Packaged Pork, B. R. Myers, J. E. Edmondson, M. E. Anderson and R. T. Marshall, Department of Food Science and Nutrition, University of Missouri-Columbia, Columbia, Missouri 65211 and U.S. Department of Agriculture, Agricultural Research Service, North Central Region, Columbia, Missouri 65211

J. Food Prot. 46:499-502

Pork loins were divided into small roasts. Thirty roasts were uninoculated and 30 were inoculated by dipping in 1% peptone water containing 100 colony-forming units (CFU)/ml of pectinolytic *Yersinia enterocolitica*. Twenty-four each of the uninoculated and inoculated roasts were sprayed with or dipped in 5 or 10% solutions of potassium sorbate. All roasts were then vacuum-packaged and stored at 5°C. After storage for 1 or 21 d, three roasts from each group were examined for psychrotrophic plate count (PPC) and the 3-tube most probable number of pectinolytic bacteria. Counts of psychrotrophs on lean surfaces of untreated controls increased by nearly 3.4 log₁₀. Numbers on sorbate-treated lean surfaces increased about 2.0 log₁₀. Growth and differences in counts on fatty surfaces were less. Numbers of pectinolytic bacteria on lean surfaces of controls increased by nearly 2.0 log₁₀, but numbers of pectinase producers did not change significantly during storage of sorbate-treated samples. Of 30 pectinolytic isolates identified from roasts stored 21 d at 5°C, 87% were *Yersinia* spp. and 13% were *Klebsiella oxytoca*. Since most of the pectinolytic isolates were psychrotrophs of public health significance, inhibition of their growth by sorbate is of particular importance.

Acetoin and Diacetyl Production by *Lactobacillus plantarum* Able to Use Citrate, S. M. El-Gendy, H. Abdel-Galil, Y. Shahnin and F. Z. Hegazi, Department of Food Science, University of Assiut, Assiut, Egypt

J. Food Prot. 46:503-505

Whole-cell suspensions of *Lactobacillus plantarum* grown on lactose in the presence of citrate did not produce acetoin and diacetyl (AD) (D) from citrate in succinate buffer, pH 4.4 unless both a source of energy and nitrogen was present, but did from pyruvate. The total AD and the amount of D, produced by citrate-grown cells, from citrate were about two times the amounts formed from pyruvate, calculated on a molar basis. It appears, that AD are formed not only from pyruvate resulting from cleavage of citrate but also from acetyl-coenzyme A arising during a probable breakdown of citrate in a reversible reaction of citrate synthetase. Neither acetate nor acetaldehyde had any effect on the total AD or the amount of D produced from pyruvate by pyruvate-grown cells. The rates of AD production from pyruvate by whole-cell suspensions of pyruvate-grown *L. plantarum* and *Streptococcus* subsp. *diacetylactis* represented only 69.7 and 6.6%, respectively, of that produced by *Lactobacillus casei*. These were 0.075 μmoles/mg dry wt⁻¹ ml⁻¹ min⁻¹ for *L. casei*, 0.053 for *L. plantarum* and 0.005 for *S. lactis* subsp. *diacetylactis*.

Factors Influencing the Agaritine Content in Cultivated Mushrooms, *Agaricus bisporus*, J. J. Speroni, R. B. Beelman, and L. C. Schisler, Departments of Food Science and Plant Pathol-

ogy, The Pennsylvania State University, University Park, Pennsylvania 16802

J. Food Prot. 46:506-509

Agaritine concentrations were determined in fresh mushrooms grown from various spawn strains on several compost types and harvested at different phases of the cropping cycle. A wild spawn strain produced mushrooms with approximately two times the agaritine content of seven other more commercially important types. Mushrooms harvested from a synthetic compost produced significantly higher amounts of agaritine than five other compost types. Additionally, mushrooms harvested later in the cropping cycle were more likely to have higher agaritine levels compared to earlier harvested mushrooms. Agaritine was also present in the mycelium of *Agaricus bisporus* growing in liquid culture, but at much lower levels than present in the fruiting bodies.

Sampling Methods and Frozen Storage of Samples for Detection of *Campylobacter jejuni* on Freshly Processed Broiler Carcasses, L. C. Blankenship, S. E. Craven, J. Y. Chiu and G. W. Krumm, Meat Quality Research Unit, R. B. Russell Agricultural Research Center, Agricultural Research Service, and Eastern Laboratory, Food Safety and Inspection Service, U.S. Department of Agriculture, Athens, Georgia 30613

J. Food Prot. 46:510-513

Swab, rinse and excision sampling methods are commonly used for detection of microorganisms on poultry carcasses. Swabbing has been the most frequently reported sampling method for *Campylobacter jejuni* on poultry. We evaluated the three methods for *C. jejuni* detection on freshly processed poultry in the following ways: (a) the interior and exterior surfaces of half of a carcass were each thoroughly rubbed with separate swabs which were combined in a test tube containing 2 ml of appropriate medium; (b) 25 g of skin and tissue samples from neck and abdominal opening cut areas were deposited in a stomacher bag with 5 ml of brucella broth (BB) and stomached for 2 min; and (c) half carcasses were shaken for 1 min with 100 ml BB in plastic bags. One drop of each sample was streaked for isolation on brucella agar containing 10% defibrinated sheep blood and Skirrow antibiotics. Isolates were identified by microscopy and appropriate cultural tests. All three sampling techniques were essentially equivalent for detection of *C. jejuni* on fresh carcasses. However, when samples were stored frozen for 7 to 10 d to simulate transport conditions from sampling locations to the laboratory, the incidence of detection was significantly reduced. Use of cryoprotective agents was an effective method to preserve swab samples during frozen storage.

Nutritional Factors Affecting Growth and Production of Antimicrobial Substances by *Streptococcus lactis* subsp. *diacetylactis* S₁-67/C, N. S. Reddy and B. Ranganathan, Southern Regional Station of the National Dairy Research Institute, Adugodi, Bangalore-560 030, India

J. Food Prot. 46:514-517

The present study pertains to the effect of nutritional factors on the growth and production of antimicrobial substances (AS) by *Streptococcus lactis* subsp. *diacetylactis* S₁-67/C. Among nine media tested, yeast extract dextrose broth supported good growth and maximum production of AS. Addition of beef extract and yeast extract at 1.0 and 0.6% levels, respectively, increased growth as well as production of AS. Of ten carbohydrates

examined, maximum production of AS was achieved with 1% glucose followed by fructose, 4% molasses, lactose, sucrose, galactose, mannitol, maltose and 2% molasses. Xylose inhibited production of AS, although it stimulated growth of the organism. Peptone, tryptone and tryptose (each at the 1.5% level) significantly stimulated production of AS. Other nitrogen sources, including soytone, casein hydrolysate and proteose peptone, retarded production of inhibitory substances. Among the amino acids, L-leucine, DL-methionine and L-glutamic acid were most essential for growth and production of AS, whereas L-lysine, L-proline, DL-serine, DL-aspartic acid, L-arginine-HCl and DL-tryptophan were stimulatory. Other amino acids such as DL-ornithine, L-cysteine-HCl and DL-citrulline slightly stimulated AS production. In the presence of cynocobalmin, niacin, folic acid, calcium pantothenate and riboflavin, *S. lactis* subsp. *diacetylactis* S₁-67/C produced maximum amounts of inhibitory substances. Omission of individual mineral salts from the basal medium did not affect production of AS by the organism.

Microflora of Tafi Cheese: Changes During Manufacture and Maturation, Graciela S. De Giori, Graciela F. De Valdéz, Aída P. De Ruiz Hologado and Guillermo Oliver, Centro de Referencia para Lactobacilos (CERELA), Instituto de Microbiología-Facultad de Bioquímica, Química y Farmacia-U.N.T., Chacabuco 145-4000, San Miguel de Tucumán, Tucumán, Argentina

J. Food Prot. 46:518-521

Changes in microbial flora during the manufacture and maturation of Argentine Tafi cheese was examined. The microbial flora was found to be predominantly mesophilic streptococci, leuconostocs and homofermentative lactobacilli. *Streptococcus lactis* predominated on the surface and in the internal portion of the cheese after pressing. *Streptococcus cremoris* reached its maximum population after salting. The main microbial types during maturation were *Lactobacillus casei* and *Lactobacillus plantarum*. Pathogenic microorganisms were not detected in any of the samples analyzed.

Enzymatic Determination of L-Glutamic Acid (L-Glutamate) in Fish Sauces and Instant Noodles, Yasuhide Tonogai, Amara Kingkate, Wanthanee Thanissorn and Udomkiat Punthanaprat, National Institute of Hygienic Sciences, Osaka Branch, 1-1-43, Hoenzaka, Hashi-ku, Osaka, Japan and Division of Food Analysis, Department of Medical Sciences, Yod-se, Bangkok 1, Thailand

J. Food Prot. 46:522-524

An enzymatic method was developed for determining L-glutamic acid in fish sauces or instant noodles. Recoveries of L-glutamic acid from spiked samples were more than 95% in all instances. A survey of glutamate in 42 samples of fish sauces (pure and mixed) and 12 samples of instant noodles (noodles and powdered soup) in Thailand, using this method, showed 33% of the samples over the Thai regulatory limit.

Heat Inactivation of Bile Salt-Stimulated Lipase Activity in Human Milk and Colostrum, S. H. L. Pan, C. W. Dill, E. S. Alford, R. L. Richter and C. Garza, Department of Animal Science, Texas A&M University, College Station, Texas 77843 and Department of Pediatrics, Baylor College of Medicine, Houston, Texas 77030

J. Food Prot. 46:525-527

Time-temperature relationships for heat-inactivation of bile salt-stimulated lipase activity in human milk and colostrum were systematically measured using a pH-stat assay procedure with triolein as substrate. The enzyme was not affected in either menstuum at 45°C for 40 min. The enzyme was destroyed almost instantaneously at 60°C, and was slightly more heat-sensitive in colostrum than in milk. The bile salt-stimulated lipase(s) in human milk was more heat sensitive than lipase in bovine milk.

Evaluation of an 18°C/45-Hour Plate Count Technique for the Enumeration of Psychrotrophic Bacteria in Raw and Pasteurized Milk, Harry K. Oehlich and Robin C. McKellar, Canadian Food Products Development Centre, Manitoba Research Council, Portage la Prairie, Manitoba, Canada R1N 3J9 and Food Research Institute, Agriculture Canada, Ottawa, Ontario, Canada K1A 0C6

J. Food Prot. 46:528-529

Bacterial counts were done at 7°C for 10 d and at 18°C for 45 h on 93 samples of raw and 185 samples of pasteurized milk. As an additional test, catalase-positive microorganisms were enumerated at 18°C/45 h. Close correlations were obtained between the numbers of microorganisms following 18°C/45-h and 7°C/10-d incubations in raw ($r^2=0.866$) and pasteurized ($r^2=0.936$) milk samples. Similar correlations ($r^2=0.860$ and 0.946) were noted for the 18°C/45-h-catalase and the 7°C/10-d methods for raw and pasteurized milk, respectively. Results suggest that incubation at 18°C for 45 h provides a reliable estimate of the numbers of psychrotrophs in raw and pasteurized milk and that the use of catalase does not improve sensitivity of the test significantly.

Distribution and Resistance to Pasteurization of Aflatoxin M₁ in Naturally Contaminated Whole Milk, Cream and Skim Milk, Dana W. Wiseman, Rhoná S. Applebaum, Robert E. Brackett and Elmer H. Marth, Department of Food Science and The Food Research Institute, University of Wisconsin, Madison, Wisconsin 53706

J. Food Prot. 46:530-532

Milk, naturally contaminated with aflatoxin M₁ (AFM₁), was separated with a hand-operated separator. Distribution of AFM₁ paralleled the partitioning of whole milk into cream and skim milk. Most of the whole milk was recovered as skim milk, which also contained most of the AFM₁. Cream accounted for 5-15% of the amount of whole milk and had 2-14% of AFM₁ that originally occurred in whole milk. Cream and skim milk were pasteurized at 64°C for 30 min. AFM₁ was stable in both products given this heat treatment.

Comparison of Methods for Isolation and Confirmation of *Clostridium perfringens* from Spices and Herbs, E. De Boer and E. M. Boot, Food Inspection Service, P.O. Box 9012, 7200 GN Zutphen, The Netherlands

J. Food Prot. 46:533-536

Rapid Perfringens Medium (RPM), Perfringens Enrichment Medium (PEM) and Tryptose Sulfite Cycloserine agar medium (TSC) were compared for determination of *Clostridium perfringens* in spices and herbs. Of 147 samples, 62 (42%) contained *C. perfringens* when RPM was used; lower percentages of positive isolations were found with PEM (23%), TSC surface plate

(19%) and TSC pour plates (26%). Heat-treatment of sample suspensions yielded additional isolates. *C. perfringens* was isolated by one or more of the techniques from 43 (80%) of 54 different kinds of spices and herbs and from 86 (59%) of 147 samples. Replacing glucose in RPM with raffinose and polymyxin and neomycin with cycloserine did not improve the efficacy of this medium. A good correlation was found between conventional confirmation tests for *C. perfringens* and tests for acid phosphatase, lecithinase, reverse CAMP test and an antiserum test.

Acetoin and Diacetyl Production by *Lactobacillus casei* subsp. *pseudopiantarum*, S. M. El-Gendy, H. Abdel-Galil, Y. Shahin and F. Z. Hegazi, Department of Food Science, University of Assiut, Assiut, Egypt

J. Food Prot. 46:537-541

The ability of *Lactobacillus casei* subsp. *pseudopiantarum* to produce acetoin and diacetyl (AD) was evaluated in succinate buffer (initial pH 4.4) containing sodium pyruvate, at 30°C. Cells grown in MRS broth containing pyruvate produced AD more rapidly than did an equal number of cells either grown in broth without pyruvate or even stored, after harvesting during logarithmic growth, in MRS broth in the presence of pyruvate for 120 minutes. One or more of the enzymes catalyzing formation of AD appears to be formed originally during growth in the presence of pyruvate. The rate of AD production by pyruvate-grown cells was exponential, being $0.08 \mu\text{moles mg dry wt}^{-1} \text{ml}^{-1} \text{min}^{-1}$ during the first 30 min of the reaction. Storage of pyruvate grown cells at 7°C for 6 h in 0.3 mmol/L, KH_2PO_4 buffer, pH 7.0 resulted in 77% loss of activity. Inclusion of 0.5 ml of MRS broth in the assay mixture led to a considerable increase in AD production by both cells grown in the absence and presence of pyruvate. Lactose slightly stimulated AD production in cells grown on lactose, whereas glucose had practically no effect on glucose-grown cells. Acetate and acetaldehyde reduced AD production. The effect varied with the compound used and strain studied. Of 7 concentrations of cetylpyridinium chloride tested for their effect on AD production, the least and most inhibitory concentration were 1 and $10 \mu\text{g ml}^{-1}$ of assay mixture.

Heterogeneity of Samples as a Problem in Shelf-Life Prediction, R. B. Maxcy and S. E. Wallen, Department of Food Science and Technology, University of Nebraska, Lincoln, Nebraska 68583-0919

J. Food Prot. 46:542-544

A study of the common assumption that a single package of milk represents the production lot was made. Sensory and microbial observations on shelf-life were of sample sets of sequentially produced cartons of milk from four different commercial operations. Neither spoilage rate nor nature of spoilage was uniform for a typical sample set of ten units. A single package, therefore, provided low probability for predicting behavior of the entire production lot. Observations on individual colonies from standard plate counts at the time of sensory spoilage indicated the microflora to be a pure culture in each spoiled unit. The extreme differences in spoilage rates of individual units within sample sets indicated sensory evaluation of multiple samples to be the most logical, simple criterion for evaluating shelf-life. The size of the sample set to be observed and frequency of sampling awaits further observations and application of statistical techniques to establish the accuracy of estimates desired.

Effect of Food Environment on Staphylococcal Enterotoxin Synthesis: A Review, J. L. Smith, R. L. Buchanan and S. A. Palumbo, Eastern Regional Research Center, Philadelphia, Pennsylvania 19118

J. Food Prot. 46:545-555

Effects of various nutritional and environmental factors on growth and enterotoxin synthesis by *Staphylococcus aureus* in model systems and foods are reviewed. Factors discussed include effects of inoculum size, competing microflora, gaseous atmosphere, carbon source, temperature, pH, sodium chloride, water activity, mineral ions and sublethal stress. Areas where additional research is needed are also discussed.

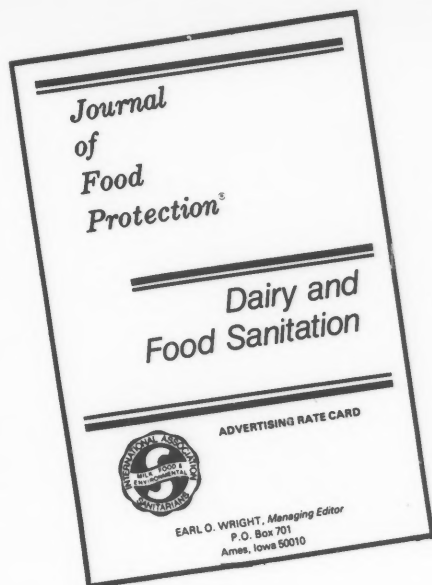

This is the place to be . . .

Mail your copy or camera ready art work *today* to:

IAMFES-Advertising
P.O. Box 701 Dept. 2
AMES, IA 50010

Ad placed in one publication

ADVERTISING RATES — Base Charge

Black & white rates	1 time	6 times	12 times
Back Cover	\$476	\$435	\$393
Inside Front Cover	464	425	383
Inside Back Cover	464	425	383
One page	414	378	342
2/3 page	315	281	252
1/2 page	252	222	195
1/3 page	180	162	145
1/4 page	138	127	109
1/8 page	100	84	73

2 color: Add \$85 per placement

4 color: Add \$275 per placement

Bleed: Add \$55 to your base charge

Ad placed in both publications (same month & copy)

ADVERTISING RATES — Base Charge

Black & white rates	1 time	6 times	12 times
Back cover	\$715	\$653	\$591
Inside Back Cover	697	636	576
Inside Front Cover	697	636	576
One page	622	568	514
2/3 page	472	422	378
1/2 page	416	380	432
1/3 page	270	244	216
1/4 page	208	190	162
1/8 page	151	126	109

Classified ads: 20¢ per word

Agency commission: 15%

Invoices due upon receipt

MECHANICAL REQUIREMENTS

Full page	7" x 10"
2/3 page (horiz.)	7" x 6½"
1/2 page (vert.)	3¾" x 10"
1/2 page (horiz.)	7" x 5"
1/3 page (horiz.)	7" x 3¾"
1/4 page (vert.)	3¼" x 4¾"
1/8 page (horiz.)	3¼" x 2½"

Negatives or camera ready artwork preferred.

Unless otherwise instructed, artwork and copy will be disposed of.

Halftone: 133 line screen

Published monthly. Closing date for all advertising is the 1st of the month preceding issue. Publication issued 10th-15th of each month.

CIRCULATION INFORMATION

Major Responsibilities

Milk and Food Quality Control	49.20%
General Sanitation	18.50
Laboratory	15.20
Teaching, Research	9.70
Industry (other than quality control)	7.40
	100.00%

The circulation of the *Journal* is international and averages 4000 copies per month. *Dairy and Food Sanitation* circulation averages 2500 copies per month.

I'M LOOKING FOR TROUBLE.

TRAINED TO FIND IT.

If something is causing you sanitation trouble, I'll find it. I'm trained in effective (and cost effective) ways to keep your operation clean and running smoothly.

TRAINED TO SOLVE IT.

I'll bring you the latest and the best product knowledge. Plus team up with veterinarians, university specialists and others to help you solve your problems.

THOROUGH.

I'll do everything I can to make your cows worth more. Including water analysis, checking water temperature, cleaning formulations and more. Because I know that proper sanitation pays off for you.

I'M ARMED TO THE TEETH.

With quality Surge detergents, acids, sanitizers and teat dips. Each a proven performer. All from a single source.

RIGHT AT YOUR SIDE.

I'm trained to work side by side with you. Doing whatever it takes to get your problems solved. And keep them solved. For the Surge sanitation program tailored to your operation, call me today. Or write Babson Bros. Co., 2100 South York Road, Oak Brook, Illinois 60521.



